



Toolholders with indexable inserts

milling, turning, grooving

09/23

Overview

<u>Information about the catalog</u>	<u>2</u>
<u>Milling tools</u>	<u>4</u>
<u>Turning tools</u>	<u>69</u>
<u>Grooving and parting-off tools</u>	<u>93</u>
<u>Indexable inserts</u>	<u>106</u>
<u>Special tools</u>	<u>122</u>
<u>Technical information</u>	<u>124</u>
<u>Cutting conditions</u>	<u>137</u>
<u>Index</u>	<u>144</u>

Grüezi and welcome!

An innovative family company since 1934

Within the manufacturing unit in Switzerland, ALES A employs highly motivated, well trained staff, sharing a wealth of experience and knowledge gained within the cutting tool industry. We are proud that we are one of the few remaining family owned businesses within our sector.

At all times we supply market leading products, offer the highest possible technical support, deliver on time at competitive prices. This is achieved via a network of some 60 global distributors ensuring continuity of supply of both products and services.

ALES A Ltd.
Schulstrasse 11
CH-5707 Seengen

Phone +41 62 767 62 62
info@alesa.ch, www.alesa.ch



Precision tool factory

Precision

We specialise in the manufacture of highly positive, sharply ground, precision cutting tools produced from HSS and carbide.

These offer the highest possible performance figures particularly on difficult materials and extraordinary applications.

We can offer engineering solutions to the most demanding machining problems reducing cycle times, vibration and tooling costs whilst improving surface finishes and chip formation. Call us now and realise the potential of ALES A!

Metal cutting with creativity

Milling: The ALES A indexable inserts which are developed and patented by us are distinguished by a high-tech cutting geometry and are being used to great success all over the world. The extensive range of ISO standard

indexable inserts is of course also equipped with our highly positive, extremely sharp ground cutting edge. ALES A indexable inserts are available in HSS-E and finest grain metal carbide. Various hard material coatings ensure a long tool life. It goes without saying that almost all our toolholders are prepared for internal coolant supply.

Turning/parting: In this area, too, we have an extensive range of toolholders for external and internal turning with the matching indexable inserts in HSS-E to ISO standard. Our ALES A GOLD high-precision ISO toolbits and cutting tools are also world-renowned. Similarly, the Minicut and Duocut parting inserts and cutting-off tools in HSS-E are a byword in the trade.

Sawing: The ALES A metal-cutting circular saws in HSS and carbide give

top performance all around. Our circular saws with steam-tempered surface or hard-material coating achieve even better life expectancy.

Nutex: The extraordinary combination of circular saw blade and holder in one tool indicates the system Nutex, Nutex Mini, Nutex Mono and Nutex Plus. With this tool it is possible to machine on CNC centres without fixings protruding out of the tool face.

Custom-made products: If you have any processing problems, we consider it our duty to be able to offer a solution. Our development department welcomes the challenge of producing special tools to individual requirements or customer drawings.

With you as partner we aim to develop visions and pursue new methods.

Our general delivery and sales conditions apply, see www.alesa.ch

Guide-line for ALESA Catalog

How do I get the best cutting value for my application?

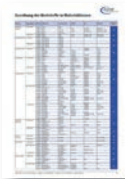

1. **Allocation of the materials and material strength** - page 140

Based on the materials table on pages 140, the assigned class of the material may be obtained by material number, material grade DIN, Euro standard EN, AFNOR (French Standards), B.S. (British Standard), AISI SAE (USA). This class of materials is for HSS and carbide tools.
In addition, the ultimate tensile strength of the material needs to be retained.



2. **Machining method** - page 4 (milling)

Choose the appropriate tool from the ALESA catalog according to your machining method, such as plan, profile, or high-feed cutting.
An overview, arranged by application, or machining method respectively, can be found on page 4.
If you need assistance, please do not hesitate to contact us.



3. **Dimensions of the tool and type of indexable inserts** - page 127 and 128

Based on consideration of machine performance, part size, and required cutting depth, select the tool diameter and the size of the inserts.
For the selection of cutting insert quality (cutting geometry and coating), you will find help in the overviews on page 127 and 128 in the catalog.

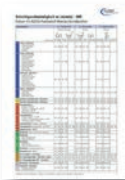

4. **Cutting speed v_c** - page 137

Based on the material class, the meshing conditions, and the coating the recommended speed can be obtained from the corresponding data table (pages 139 - 141). The resulting tool speed can be calculated with the selected tool diameter (page 136).
Please note the kappa angle.



5. **Calculation through average chip thickness «hm» and feed per tooth «fz»** - page 130/131

With the permissible «hm» value for the average chip thickness (page 130) and the involvement of «ae in % of the tool diameter,» the feed per tooth can be obtained through the hm-fz table (90°, 45° or 15°) on page 131.
With the available data, the feed rate (Vf) can now be calculated (page 134).



6. **Calculation of the chip removal rate «Q»** - page 134

The chip removal rate is a reliable factor to be able to compare the effectiveness of the processing.
The chip removal rate is calculated with:
 $Q = \text{cutting depth «ap»} \times \text{width of cut ae} \times \text{feed «Vf»} / 1000$
This formula also can again be found on page 134.



7. **Inspection and process corrections** - page 133

After the working process has been started, conclusions about the processing time and tool life can be made. This way the processing cost and tool cost per part can be calculated.
Corrective action according to page 133 can be made with the assessment of wear of the cutting tool.

Basic processing recommendations:

- Tool overhang as long as necessary but as briefly as possible
- Provide stable expansion operations, avoid vibrations
- Radial and axial run-out of the tools according to the manufacturer's instructions
- Large depth of cut, small cutting width (cutting insert length advantage, $ae < 35\%$)
- hm values and V_c conditions according to manufacturer
- climb milling cutting only

Milling tools

Profile milling

					
TN 11 DELTA	TN 11/18 DELTA	AO 10 Twist	AO 10 Twist	AO 15 Twist	AO 15 Twist
Ø 25 - 32	Ø 43 - 103	Ø 16 - 32	Ø 32 - 50	Ø 25 - 40	Ø 40 - 80
No 1306, 1308	No 1303, 1304	No 1347, 1348	No 1311	No 1347, 1348	No 1311
p. 8	p. 10	p. 12	p. 14	p. 16	p. 18
					
AO 15 Coolex	AO 20 Twist	AP 16	AP 16		
Ø 40 - 63	Ø 50 - 100	Ø 25 - 40	Ø 40 - 160		
No 1340	No 1312	No 1345	No 1310		
p. 20	p. 22	p. 24	p. 26		

Hobbing

	
TN 11 DELTA	TN 11 / 18 DELTA
Ø 25 - 32	Ø 43 - 83
No. 1354	No. 1354 / 1356
p. 30	p. 32

Fine finish milling

	
TN 18 R/e DELTA	AO 15 e Twist
Ø 43 - 125	Ø 40 - 125
No 1304	No 1311
p. 36	p. 38

Face milling 45°



XO 06 HEPTA

Ø 40 - 160

No 1330

p. 42



SD 09

Ø 16 - 40

No 1349

p. 44



SD 09

Ø 40 - 100

No 1316

p. 46



SD 12

Ø 50 - 160

No 1319

p. 48

High feed milling



SD 09 SPEED 15°

Ø 12 - 25

No 1352, 1353

p. 52



SD 09 SPEED 15°

Ø 32 - 50

No 1318

p. 54



SD 12 SPEED 15°

Ø 50 - 83

No 1322

p. 56



AO10 481/581/681

Ø 16 - 32

No 1347, 1348

p. 58



AO10 481/581/681

Ø 32 - 50

No 1311

p. 60

Milling with button inserts



RP 06 / 08 / 10

Ø 16 - 32

No 1326, 1327

p. 64



RP 12

Ø 40 - 160

No 1301

p. 66

Profile milling 90°

ALESA Delta

The characteristics

- .. us de Schwiiz! All milling cutter tools as well as the indexable inserts are designed and manufactured in Switzerland.
- Unique 20° helix angle, this peeling cutting process is very spindle and machine friendly.
- The sharp edges require less spindle power.
- The wedge-shaped positioning of the DELTA indexable inserts into the tool bodies are very process secure. This design allows a repetitively and high accuracy assembly of the indexable inserts.
- The special screws of the Delta inserts have an important function.
- Only when tightened with the correct torque, the screws ensure a process secure positioning of the inserts in the insert pockets.
- The DELTA tools have uneven pitch.
- This feature together with the peeling cutting process and a good balancing are ideal circumstances for milling processes on 5-axes machine centers.
- All DELTA tools made for internal coolant supply, there are holes for each insert pocket and for central coolant supply also.



The benefits and options for you

- TNFU11 for cutting depth (ap) up to 8 mm, TNFU18 ap up to 13 mm.
- The milling cutters TN11 available in Ø 25 mm – Ø 32 mm with Weldon shank or as threaded type version, the milling cutter TN11 Ø 43 mm shell mill.
- The cutters TN18 are shell mills available in Ø 43 mm – Ø 103 mm (125 mm).
- All diameters are available as hob milling cutters also.
- We recommend the PVD coated indexable inserts for the following applications:
 - Carbide CTS with AlCrN-VA for material classification (MC) 4 (NON-ferrous metals) and MC 6 (synthetic materials).
 - In addition we recommend CTS with DLC-H coating especially for cast aluminum and fiber enforced composite materials.
 - Carbide CTS-X / TiNox for MC 1 (steel), MC 2 (stainless steel) and for Duplex alloys < 800 N/mm².
 - Carbide CTM / TiNox in den MC 5 (Ni- / Ti- / Co- based alloys) and for Super-Duplex alloys > 800 N/mm²
 - The CTM carbide quality has a very high fracture toughness. We recommend those CTM / TiNox indexable inserts for rough application in hobbing processes in MC 1 – 3 and MC 5 as alternative to CTS-X.
- Those DELTA indexable inserts allow dry or wet machining.
- NEW DELTA TNFU18 CTS-G with TiNox-G. We recommend this finest grain carbide quality for fine finishing milling in cast or steel alloys under try or mist coolant condition. (not suitable for wet machining)
- For special tools, our construction with great experience is available.



Profile milling 90°

ALESA Twist

The characteristics

- THE original of the high-positive, sharp-ground indexable inserts milling cutters
- .. us de Schwiiz! The milling head and cutting inserts are completely manufactured in Switzerland.
- Unique with 20° helix angle
- The peeling cutting process is very spindle and machine-friendly
- The sharp edges require less spindle power and the cutting forces are much lower
- The ALESA TWIST and DELTA tools are optimized for modern 5-axis milling cutters
- All tools are provided with cooling holes. The cooling medium is exactly there where it is needed
- The best PVD coatings are available
- There are HSS and carbide inserts available from the warehouse with different radii

The benefits and options for you

- Fast delivery from the Seengen warehouse
- There are HSS and carbide inserts available
- From Ø 16 mm to Ø 50 mm on AOFT 10
- From Ø 25 mm to Ø 80 mm on AOFT 15
- From Ø 50 mm to Ø 100 mm on AOFT 20
- From Ø 25 mm to Ø 43 mm on TNFU 11
- From Ø 43 mm to Ø 103 mm on TNFU 18
- Carbide grades are available for dry and wet machining
- HSS is more reliable and powerful for many applications
- High removal rate (Q) with a relatively small machine load
- Good tool life with high productivity
- With the high feed cutting insert type 481/581 it can also be used for 6xD - 10xD tool extensions
- Outstanding machining characteristics, also with the most difficult Ni-, Ti- and Co- alloys
- Manufactured according to ISO certified processes
- For special tools, our construction with great experience is available



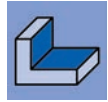

ALESA DELTA end mill and threaded type cutter

TN 11 R 90° / Ø 25 - 32

1306 / 1308

Profile milling



Part No	Type	Type	D mm	l2 mm	d2 mm	G	l1 mm	ap mm				WSP
1306.0382	25-TN 11 R	A3	25	38	20		90	8	✓	4	r	TN11 S4
1306.0392	25-TN 11 R	A2	25	38	20		90	8	✓	4	r	TN11 S4
1308.0382	25-TN 11 R		25	35	12.5	M12	55	8	✓	4	r	TN11 S4
1306.0422	32-TN 11 R	A3	32	38	25		96	8	✓	5	r	TN11 S4
1308.0422	32-TN 11 R		32	42	17	M16	64	8	✓	5	r	TN11 S4

Tool will be delivered with holder, all screws and torque wrench, but without indexable inserts.

Accessories / spare parts

Part No	Torx screw				Screw-driver	
	Qty	Article	Type	Torque	Article	Type
1306.0382	4	1490.0275	M3 x 8.2	1.8 Nm	1492.0450	T9
1306.0392	4	1490.0275	M3 x 8.2	1.8 Nm	1492.0450	T9
1308.0382	4	1490.0275	M3 x 8.2	1.8 Nm	1492.0450	T9
1306.0422	5	1490.0275	M3 x 8.2	1.8 Nm	1492.0450	T9
1308.0422	5	1490.0275	M3 x 8.2	1.8 Nm	1492.0450	T9



ALESA DELTA: the spiral ground indexable insert for a smooth and vibration-free chip removal for any metals.



Highly positive, extremely sharp cutting edge of carbide.



When milling slots with an internal cooling system set operating pressure above 20 bar. Ensure clear chip removal.



Profile milling



Slot milling



Face milling

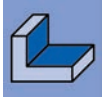

ALESA DELTA end mill and threaded type cutter

TN 11 R 90° / Ø 25 - 32

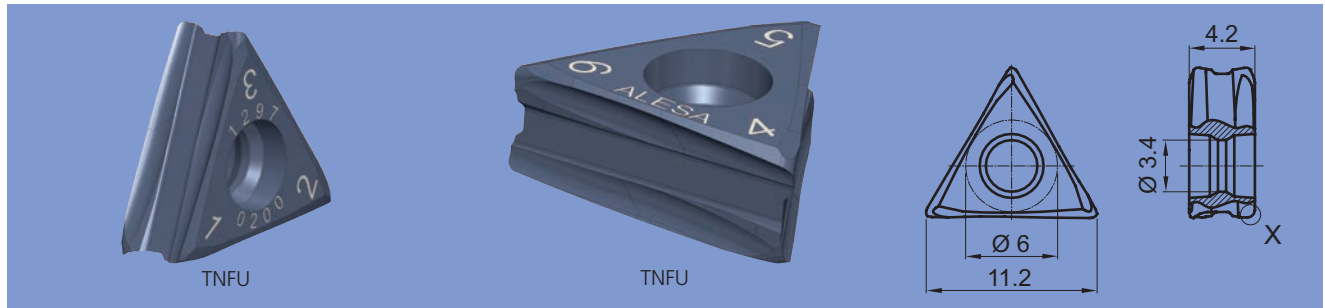

Profile milling

Cutting material	Coating	Part No	ISO Code	Detail X				Werkstoffklassen					
								1	2	3	4	5	6
Carbide CTS	AlCrN-VA	1297.0200	TNFU 11 S4 04 FR-321	R 0.4	r	●	○	●	○	○	○		
		1297.0650	TNFU 11 S4 PF FR-321	0.2x45°	r	●	○	●	○	○	○		
	DLC-H	1297.0201	TNFU 11 S4 04 FR-321	R 0.4	r	●	○	○	●	○	●		
		1297.0651	TNFU 11 S4 PF FR-321	0.2x45°	r	●	○	○	●	○	●		
Carbide CTS-X	TiNox	1297.0267	TNFU 11 S4 04 FR-731	R 0.4	r	●	○	○	○	○	○		
		1297.0717	TNFU 11 S4 PF FR-731	0.2x45°	r	●	○	○	○	○	○		
Carbide CTM	TiNox	1297.0317	TNFU 11 S4 04 FR-931	R 0.4	r	●	○	○	○	○	●		

Fitting instructions for inserts see page 136

Zusatznummer Wendeschneidplatten ISO-Code (Schneidengeometrie)
 Additional number indexable inserts ISO-code (cutting geometry)
 Numéro supplémentaire plaquettes amovibles code ISO (géométrie de coupe)

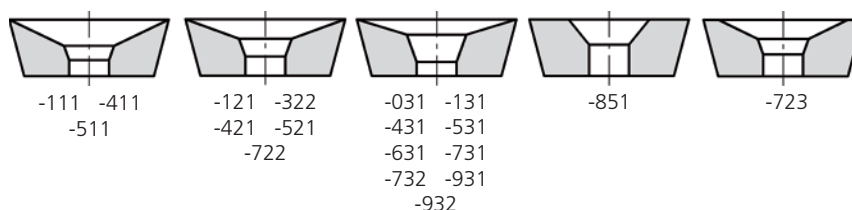

Overview of all indexable inserts see page 106 and following.

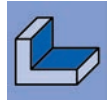

ALESA DELTA milling cutter

TN 11 / 18 - R 90° / Ø 43 - 103

1303 / 1304

Profile milling



1303.0463 - TN 11



1304.0483 - TN 18

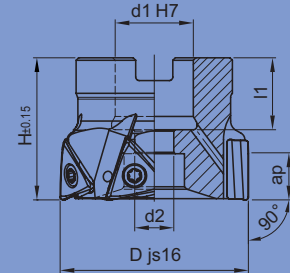

Part No	Type	D mm	H mm	d1 mm	d2 mm	l1 mm	ap mm				WSP
1303.0463	43-TN 11 R	43	32	16	8.5	18	8	✓	6	r	TNFM 11 S4
1304.0463	43-TN 18 R	43	32	16	8.5	18	13	✓	4	r	TNFM 18 07
1304.0483	53-TN 18 R	53	40	22	11	20	13	✓	6	r	TNFM 18 07
1304.0503	66-TN 18 R	66	40	22	11	20	13	✓	7	r	TNFM 18 07
1304.0523	83-TN 18 R	83	50	27	14	22	13	✓	9	r	TNFM 18 07
1304.0543	103-TN 18 R	103	50	32	18	25	13	✓	10	r	TNFM 18 07

Tool will be delivered with holder, all screws and torque wrench, but without indexable inserts.

Part No	Torx screw				Screw-driver		Hex socket head screw		
	Qty	Article	Type	Torque	Article	Type	Article	Type	Torque
1303.0463	6	1490.0275	M3 x 8.2	1.8 Nm	1492.0450	T9	1490.0759	M8 x 20	30 Nm
1304.0463	4	1490.0385	M5 x 11.5	5 Nm	1492.0650	T20	1490.0759	M8 x 20	30 Nm
1304.0483	6	1490.0395	M5 x 14.5	5 Nm	1492.0650	T20	1490.0770	M10 x 25	50 Nm
1304.0503	7	1490.0395	M5 x 14.5	5 Nm	1492.0650	T20	1490.0770	M10 x 25	50 Nm
1304.0523	9	1490.0395	M5 x 14.5	5 Nm	1492.0650	T20	1490.0780	M12 x 30	90 Nm
1304.0543	10	1490.0395	M5 x 14.5	5 Nm	1492.0650	T20	1490.0789	M16 x 30	160 Nm



ALESA DELTA: the spiral ground indexable insert for a smooth and vibration-free chip removal for any metals.



Highly positive, extremely sharp cutting edge of carbide.



When milling slots with an internal cooling system set operating pressure above 20 bar. Ensure clear chip removal.



Profile milling



Slot milling



Face milling

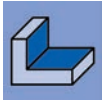

ALESA DELTA milling cutter

TN 11 / 18 - R 90° / Ø 43 - 103

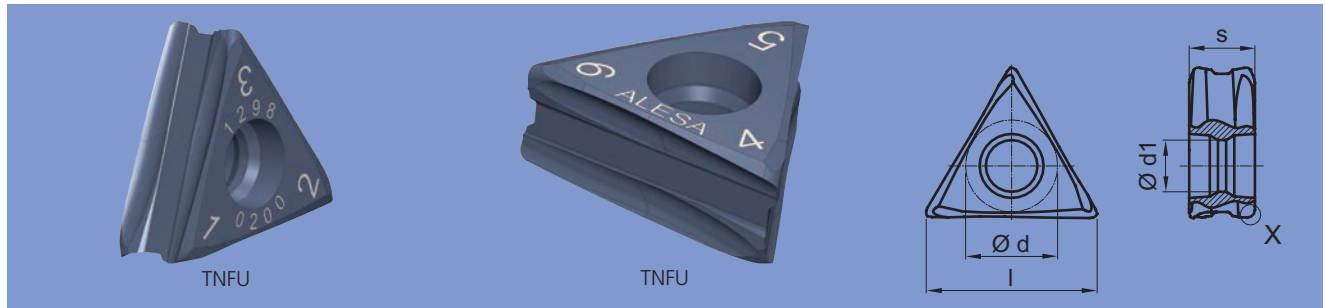

Profile milling

Cutting material	Coating	Part No	ISO Code	l mm	s mm	d mm	d1 mm	Detail X	🔥	✂️	Material classes					
											1	2	3	4	5	6
Carbide CTS	AlCrN-VA	1297.0200	TNFU 11 S4 04 FR-321	11.2	4.2	6	3.4	R 0.4	●	○	●	○	○	○	○	
		1297.0650	TNFU 11 S4 PF FR-321	11.2	4.2	6	3.4	0.2x45°	●	○	●	○	○	○	○	
		1298.0200	TNFU 18 07 08 FR-321	18.3	7	9.8	5.5	R 0.8	●	○	●	○	○	○	○	
		1298.0650	TNFU 18 07 PF FR-321	18.3	7	9.8	5.5	0.2x45°	●	○	●	○	○	○	○	
	DLC-H	1297.0201	TNFU 11 S4 04 FR-321	11.2	4.2	6	3.4	R 0.4	●	○	○	○	●	●	○	
		1297.0651	TNFU 11 S4 PF FR-321	11.2	4.2	6	3.4	0.2x45°	●	○	○	○	●	●	○	
		1298.0201	TNFU 18 07 08 FR-321	18.3	7	9.8	5.5	R 0.8	●	○	○	○	●	●	○	
		1298.0651	TNFU 18 07 PF FR-321	18.3	7	9.8	5.5	0.2x45°	●	○	○	○	●	●	○	
Carbide CTS-X	TiNox	1297.0267	TNFU 11 S4 04 FR-731	11.2	4.2	6	3.4	R 0.4	●	○	○	●	○	○	○	
		1297.0717	TNFU 11 S4 PF FR-731	11.2	4.2	6	3.4	0.2x45°	●	○	○	●	○	○	○	
		1298.0267	TNFU 18 07 08 FR-731	18.3	7	9.8	5.5	R 0.8	●	○	○	●	○	○	○	
		1298.0717	TNFU 18 07 PF FR-731	18.3	7	9.8	5.5	0.2x45°	●	○	○	●	○	○	○	
Carbide CTM	TiNox	1297.0317	TNFU 11 S4 04 FR-931	11.2	4.2	6	3.4	R 0.4	●	○	○	○	○	●	○	
		1298.0317	TNFU 18 07 08 FR-931	18.3	7	9.8	5.5	R 0.8	●	○	○	○	○	●	○	
Carbide CTS-G	TiNox-G	1298.0318	TNFU 18 07 08 FR-031	18.3	7	9.8	5.5	R 0.8	○	●	○	○	○	○	○	

Fitting instructions for inserts see page 136

Zusatznummer Wendeschneidplatten ISO-Code (Schneidengeometrie)
 Additional number indexable inserts ISO-code (cutting geometry)
 Numéro supplémentaire plaquettes amovibles code ISO (géométrie de coupe)

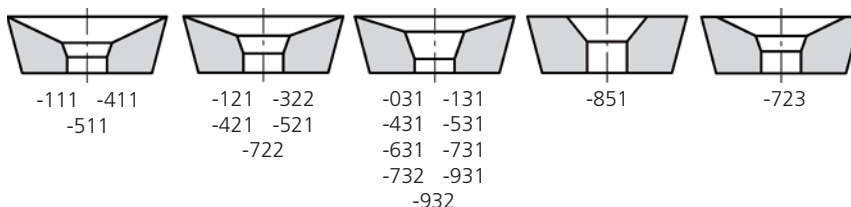

Overview of all indexable inserts see page 106 and following.

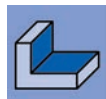

ALESA TWIST end mill and threaded type cutter

AO 10 R 90° / Ø 16 - 32

1347 - 10 / 1348 - 10

Profile milling



Part No	Type	D mm	l2 mm	d2 mm	G	l1 mm	ap mm				WSP
1347.0300	16-AO 10 R	16	25	16		75	8	✓	2	r	AOFT 10 03
1348.0300	16-AO 10 R	16	25	8.5	M8	41	8	✓	2	r	AOFT 10 03
1347.0338	20-AO 10 R Z2	20	30	20		82	8	✓	2	r	AOFT 10 03
1347.0340	20-AO 10 R Z3	20	30	20		82	8	✓	3	r	AOFT 10 03
1348.0340	20-AO 10 R	20	30	10.5	M10	48	8	✓	3	r	AOFT 10 03
1347.0382	25-AO 10 R	25	38	25		96	8	✓	4	r	AOFT 10 03
1348.0382	25-AO 10 R	25	35	12.5	M12	55	8	✓	4	r	AOFT 10 03
1348.0422	32-AO 10 R	32	42	17	M16	64	8	✓	5	r	AOFT 10 03

Tool will be delivered with holder, all screws and screw-driver, but without indexable inserts.

Accessories / spare parts

Part No	Torx screw				Screw-driver	
	Qty	Article	Type	Torque	Article	Type
1347.0300	2	1491.0210	M2.5 x 4	0.95 Nm	1493.0300	TP7 IP
1348.0300	2	1491.0210	M2.5 x 4	0.95 Nm	1493.0300	TP7 IP
1347.0338	2	1491.0220	M2.5 x 5	0.95 Nm	1493.0300	TP7 IP
1347.0340	3	1491.0220	M2.5 x 5	0.95 Nm	1493.0300	TP7 IP
1348.0340	3	1491.0220	M2.5 x 5	0.95 Nm	1493.0300	TP7 IP
1347.0382	4	1491.0220	M2.5 x 5	0.95 Nm	1493.0300	TP7 IP
1348.0382	4	1491.0220	M2.5 x 5	0.95 Nm	1493.0300	TP7 IP
1348.0422	5	1491.0220	M2.5 x 5	0.95 Nm	1493.0300	TP7 IP



ALESA TWIST: the patented spiral ground indexable insert for a smooth and vibration-free chip removal for any metals. The full cutting edge is useable (ap).



The high performance tool with 2 cutting edges allows slot milling in one process step.



Slot milling: for slot depths > 40% ap, use only tools with 2 cutting edges.



Stainless steels (V2A) can be machined dry with AlCrN coated inserts.



Profile milling



Slot milling



Face milling

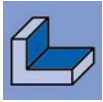

ALESA TWIST end mill and threaded type cutter

AO 10 R 90° / Ø 16 - 32

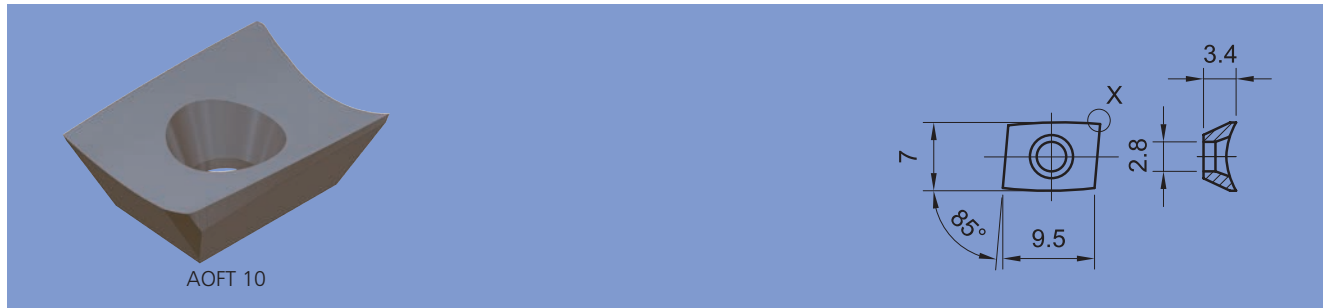

Profile milling

Cutting material	Coating	Part No	ISO Code	Detail X				Werkstoffklassen					
								1	2	3	4	5	6
HSS-E	TiN	1087.0170	AOFT 10 03 PF FR	0.2x45°	r	●		○	○		●		●
		1087.0180	AOFT 10 03 04 FR	R 0.4	r	●		○	○		●		●
	TiAlN	1162.0170	AOFT 10 03 PF FR	0.2x45°	r	●		○	●		●	○	●
		1162.0180	AOFT 10 03 04 FR	R 0.4	r	●		○	●		●	○	●
Carbide HM	TiN	1287.0200	AOFT 10 03 PF FR-411	0.2x45°	r	●	○	○	○	●	●		●
		1287.0205	AOFT 10 03 04 FR-411	R 0.4	r	●	○	○	○	●	●		●
	TiAlN	1287.0300	AOFT 10 03 PF FR-411	0.2x45°	r	●	○	○	○	●	●		●
		1287.0305	AOFT 10 03 04 FR-411	R 0.4	r	●	○	○	○	●	●		●
	AlCrN	1287.0651	AOFT 10 03 PF FR-421	0.2x45°	r	●	○	●	●	●	●	○	●
		1287.0656	AOFT 10 03 04 FR-421	R 0.4	r	●	○	●	●	●	●	○	●
		1287.0657	AOFT 10 03 04 FR-431	R 0.4	r	●	○	●	●	○	○	●	○
		1287.0757	AOFT 10 03 04 FR-431	R 0.4	r	●	○	●	●	○	○	●	○
Carbide HM-F	AlCrN	1287.0701	AOFT 10 03 PF FR-521	0.2x45°	r		●	●	●	●	●		●
		1287.0706	AOFT 10 03 04 FR-521	R 0.4	r		●	●	●	●	●		●
	1287.0707	AOFT 10 03 04 FR-531	R 0.4	r		●	●	○					
	AlCrN-VA	1287.0807	AOFT 10 03 04 FR-531	R 0.4	r		●	●	○				
Carbide HA	AlCrN-VA	1289.0202	AOFT 10 03 04 FR-631	R 0.4	r	●	○	○	●			●	

Fitting instructions for inserts see page 136

Zusatznummer Wendeschneidplatten ISO-Code (Schneidengeometrie)
 Additional number indexable inserts ISO-code (cutting geometry)
 Numéro supplémentaire plaquettes amovibles code ISO (géométrie de coupe)

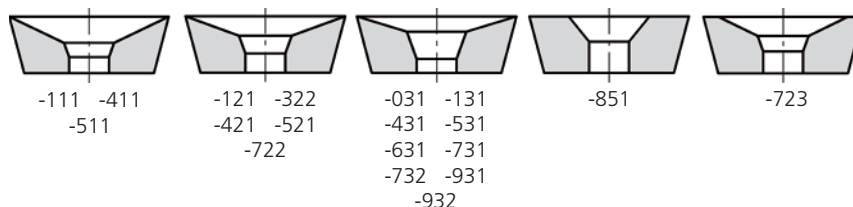

Overview of all indexable inserts see page 106 and following.

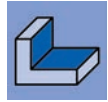

ALESA TWIST milling cutter

AO 10 R 90° / Ø 32 - 50

1311 - 10

Profile milling

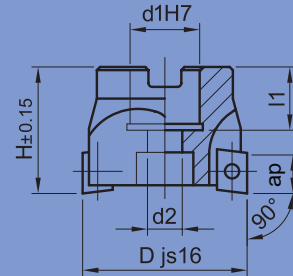
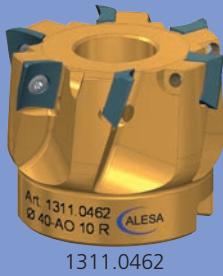

Part No	Type	D mm	H mm	d1 mm	d2 mm	l1 mm	ap mm				WSP
1311.0422	32-AO 10 R	32	28	13	6.5	15	8	✓	5	r	AOFT 10 03
1311.0462	40-AO 10 R	40	32	16	8.5	18	8	✓	6	r	AOFT 10 03
1311.0482	50-AO 10 R	50	40	22	11	20	8	✓	8	r	AOFT 10 03

Tool will be delivered with holder, all screws and screw-driver, but without indexable inserts.

Part No	Torx screw				Screw-driver		Hex socket head screw		
	Qty	Article	Type	Torque	Article	Type	Article	Type	Torque
1311.0422	5	1491.0220	M2.5 x 5	0.95 Nm	1493.0300	TP7 IP	1490.0750	M6 x 20	10 Nm
1311.0462	6	1491.0220	M2.5 x 5	0.95 Nm	1493.0300	TP7 IP	1490.0759	M8 x 20	30 Nm
1311.0482	8	1491.0220	M2.5 x 5	0.95 Nm	1493.0300	TP7 IP	1490.0770	M10 x 25	50 Nm



ALESA TWIST: the patented spiral ground indexable insert for a smooth and vibration-free chip removal for any metals. The full cutting edge is useable (ap).



Highly positive, extremely sharp cutting edge of HSS-E and carbide.



Stainless steels (V2A) can be machined dry with AlCrN coated inserts.



Profile milling



Slot milling



Face milling

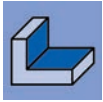

ALESA TWIST milling cutter

AO 10 R 90° / Ø 32 - 50

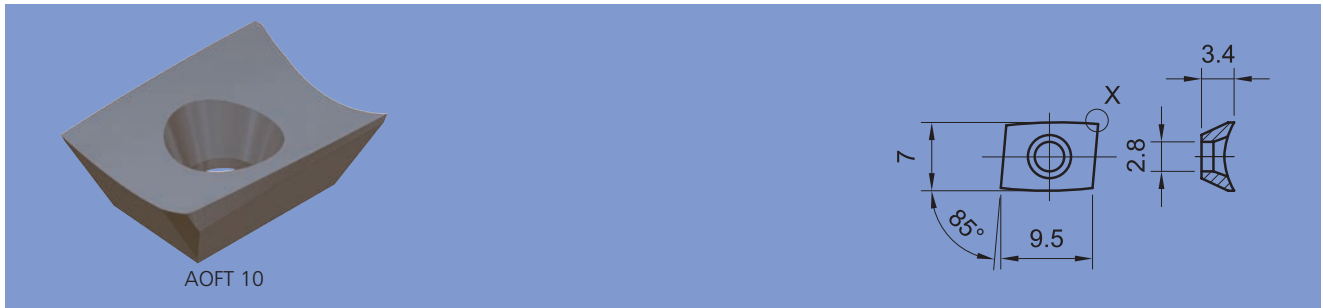

Profile milling

Cutting material	Coating	Part No	ISO Code	Detail X				Werkstoffklassen					
								1	2	3	4	5	6
HSS-E	TiN	1087.0170	AOFT 10 03 PF FR	0.2x45°	r	●		○	○		●		●
		1087.0180	AOFT 10 03 04 FR	R 0.4	r	●		○	○		●		●
	TiAlN	1162.0170	AOFT 10 03 PF FR	0.2x45°	r	●		○	●		●	○	●
		1162.0180	AOFT 10 03 04 FR	R 0.4	r	●		○	●		●	○	●
Carbide HM	TiN	1287.0200	AOFT 10 03 PF FR-411	0.2x45°	r	●	○	○	○	●	●		●
		1287.0205	AOFT 10 03 04 FR-411	R 0.4	r	●	○	○	○	●	●		●
	TiAlN	1287.0300	AOFT 10 03 PF FR-411	0.2x45°	r	●	○	○	○	●	●		●
		1287.0305	AOFT 10 03 04 FR-411	R 0.4	r	●	○	○	○	●	●		●
	AlCrN	1287.0651	AOFT 10 03 PF FR-421	0.2x45°	r	●	○	●	●	●	●	○	●
		1287.0656	AOFT 10 03 04 FR-421	R 0.4	r	●	○	●	●	●	●	○	●
		1287.0657	AOFT 10 03 04 FR-431	R 0.4	r	●	○	●	●	○	○	●	○
		1287.0757	AOFT 10 03 04 FR-431	R 0.4	r	●	○	●	●	○	○	●	○
Carbide HM-F	AlCrN	1287.0701	AOFT 10 03 PF FR-521	0.2x45°	r		●	●	●	●	●		●
		1287.0706	AOFT 10 03 04 FR-521	R 0.4	r		●	●	●	●	●		●
	AlCrN-VA	1287.0707	AOFT 10 03 04 FR-531	R 0.4	r		●	●	○				
		1287.0807	AOFT 10 03 04 FR-531	R 0.4	r		●	●	○				
Carbide HA	AlCrN-VA	1289.0202	AOFT 10 03 04 FR-631	R 0.4	r	●	○	○	●			●	
Carbide HM-F	TiN	Test.arti	AOFT 10 03 PF FR	0.2x45°		●		○	○		●		●

Fitting instructions for inserts see page 136

Zusatznummer Wendeschneidplatten ISO-Code (Schneidengeometrie)
 Additional number indexable inserts ISO-code (cutting geometry)
 Numéro supplémentaire plaquettes amovibles code ISO (géométrie de coupe)

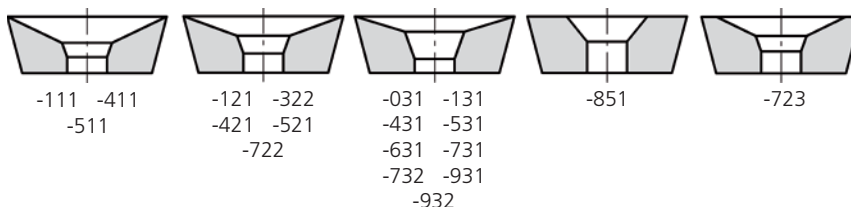

Overview of all indexable inserts see page 106 and following.



ALESA TWIST end mill and threaded type cutter

AO 15 R 90° / Ø 25 - 40

1347 - 15 / 1348 - 15

Profile milling



Part No	Type	D mm	l2 mm	d2 mm	G	l1 mm	ap mm				WSP
1347.0378	25-AO 15 R	25	38	20		90	13	✓	2	r	AOFT 15 T3
1347.0380	25-AO 15 R	25	38	25		96	13	✓	2	r	AOFT 15 T3
1348.0380	25-AO 15 R	25	40	12.5	M12	60	13	✓	2	r	AOFT 15 T3
1347.0408*	32-AO 15 R Z2	32	38	25		96	13	✓	2	r	AOFT 15 T3
1347.0410	32-AO 15 R Z3	32	38	25		96	13	✓	3	r	AOFT 15 T3
1347.0418*	32-AO 15 R Z2	32	38	32		100	13	✓	2	r	AOFT 15 T3
1347.0420	32-AO 15 R Z3	32	38	32		100	13	✓	3	r	AOFT 15 T3
1348.0418	32-AO 15 R Z2	32	44	17	M16	66	13	✓	2	r	AOFT 15 T3
1348.0420	32-AO 15 R Z3	32	44	17	M16	66	13	✓	3	r	AOFT 15 T3
1347.0458*	40-AO 15 R Z2	40	48	32		110	13	✓	2	r	AOFT 15 T3
1347.0460	40-AO 15 R Z4	40	48	32		110	13	✓	4	r	AOFT 15 T3

*while stocks last

Tool will be delivered with holder, all screws and screw-driver, but without indexable inserts.

Accessories / spare parts

Part No	Torx screw				Screw-driver	
	Qty	Article	Type	Torque	Article	Type
1347.0378	2	1490.0280	M3.5 x 7	2.55 Nm	1492.0500	T15
1347.0380	2	1490.0280	M3.5 x 7	2.55 Nm	1492.0500	T15
1348.0380	2	1490.0280	M3.5 x 7	2.55 Nm	1492.0500	T15
1347.0408	2	1490.0280	M3.5 x 7	2.55 Nm	1492.0500	T15
1347.0410	3	1490.0280	M3.5 x 7	2.55 Nm	1492.0500	T15
1347.0418	2	1490.0280	M3.5 x 7	2.55 Nm	1492.0500	T15
1347.0420	3	1490.0280	M3.5 x 7	2.55 Nm	1492.0500	T15
1348.0418	2	1490.0280	M3.5 x 7	2.55 Nm	1492.0500	T15
1348.0420	3	1490.0280	M3.5 x 7	2.55 Nm	1492.0500	T15
1347.0458	2	1490.0280	M3.5 x 7	2.55 Nm	1492.0500	T15
1347.0460	4	1490.0280	M3.5 x 7	2.55 Nm	1492.0500	T15



ALESA TWIST: the patented spiral ground indexable insert for a smooth and vibration-free chip removal for any metals. The full cutting edge is useable (ap).



The high performance tool with 2 cutting edges allows slot milling in one process step.



Slot milling: for slot depths > 40% ap, use only tools with 2 cutting edges.



Stainless steels (V2A) can be machined dry with AlCrN coated inserts.



Profile milling



Slot milling



Face milling

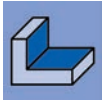

ALESA TWIST end mill and threaded type cutter

AO 15 R 90° / Ø 25 - 40

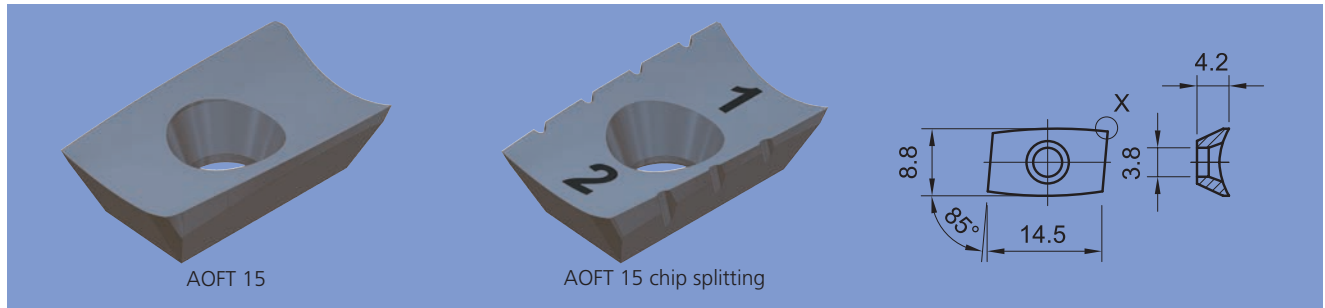

Profile milling

Cutting material	Coating	Part No	ISO Code	Detail X				Werkstoffklassen					
								1	2	3	4	5	6
HSS-E	TiN	1087.0190	AOFT 15 T3 PF FR	0.2x45°	r	●		○	○		●		●
		1087.0210	AOFT 15 T3 08 FR	R 0.8	r	●		○	○		●		●
	TiAlN	1162.0190	AOFT 15 T3 PF FR	0.2x45°	r	●		○	●		●	○	●
		1162.0210	AOFT 15 T3 08 FR	R 0.8	r	●		○	●		●	○	●
HSS-E chip splitting °)	TiN	1087.0508	AOFT 15 T3 PF FR (No 3)	0.2x45°	r	●		○	○		●		●
		1087.0505	AOFT 15 T3 PF FR (No 1/2)	0.2x45°	r	●		○	○		●		●
Carbide HM	TiN	1287.0210	AOFT 15 T3 PF FR-411	0.2x45°	r	●	○	○	○	●	●		●
		1287.0215	AOFT 15 T3 08 FR-411	R 0.8	r	●	○	○	○	●	●		●
	TiAlN	1287.0310	AOFT 15 T3 PF FR-411	0.2x45°	r	●	○	○	○	●	●		●
		1287.0315	AOFT 15 T3 08 FR-411	R 0.8	r	●	○	○	○	●	●		●
	AlCrN	1287.0661	AOFT 15 T3 PF FR-421	0.2x45°	r	●	○	○	○	●	●	○	●
		1287.0666	AOFT 15 T3 08 FR-421	R 0.8	r	●	○	○	○	●	●	○	●
		1287.0667	AOFT 15 T3 08 FR-431	R 0.8	r	●	○	○	○	●	○	○	○
		1287.0669	AOFT 15 T3 12 FR-421	R 1.2	r	●	○	○	○	●	●	○	○
	AlCrN-VA	1287.0671	AOFT 15 T3 16 FR-421	R 1.6	r	●	○	○	○	●	●	○	○
		1287.0673	AOFT 15 T3 20 FR-421	R 2.0	r	●	○	○	○	●	●	○	○
	DLC-H	1287.0767	AOFT 15 T3 08 FR-431	R 0.8	r	●	○	○	○	●	○	○	○
		1287.0916	AOFT 15 T3 08 FR-421	R 0.8	r	●	○	○	○	●	○	○	○
Carbide HM-F	TiAlN	1287.0510	AOFT 15 T3 PF FR-511	0.2x45°	r		●	○	○	●			●
		1287.0515	AOFT 15 T3 08 FR-511	R 0.8	r		●	○	○	●			●
	AlCrN	1287.0711	AOFT 15 T3 PF FR-521	0.2x45°	r		●	○	○	●	○		●
		1287.0716	AOFT 15 T3 08 FR-521	R 0.8	r		●	○	○	●	○		●
	AlCrN-VA	1287.0717	AOFT 15 T3 08 FR-531	R 0.8	r		●	○	○	●	○		○
		1287.0817	AOFT 15 T3 08 FR-531	R 0.8	r		●	○	○	●	○		○
DLC-H	1287.0967	AOFT 15 T3 08 FR-531	R 0.8	r		●	○	○	●	○		○	
Carbide HA	AlCrN-VA	1289.0232	AOFT 15 T3 08 FR-631	R 0.8	r	●	○	○	○	●		○	○

°) Order of inserts with chip splitting see page 136
Fitting instructions for inserts see page 136

Zusatznummer Wendeschneidplatten ISO-Code (Schneidengeometrie)
Additional number indexable inserts ISO-code (cutting geometry)
Numéro supplémentaire plaquettes amovibles code ISO (géométrie de coupe)

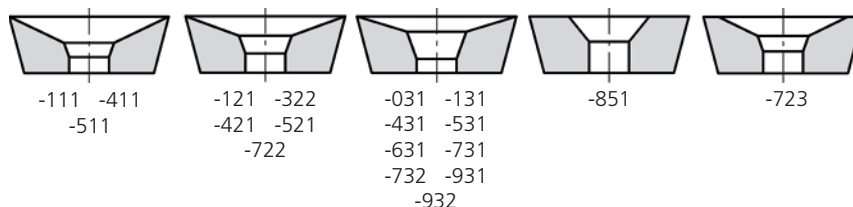

Overview of all indexable inserts see page 106 and following.

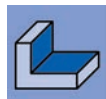

ALESA TWIST milling cutter

AO 15 R 90° / Ø 40 - 80

1311 - 15

Profile milling



1311.0480

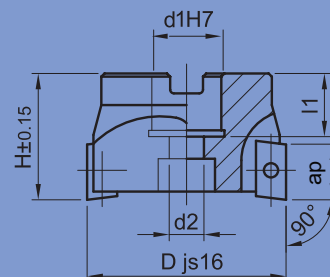

Part No	Type	D mm	H mm	d1 mm	d2 mm	l1 mm	ap mm				WSP
1311.0460	40-AO 15 R	40	32	16	8.5	18	13	✓	4	r	AOFT 15 T3
1311.0480	50-AO 15 R	50	40	22	11	20	13	✓	6	r	AOFT 15 T3
1311.0500	63-AO 15 R	63	40	22	11	20	13	✓	7	r	AOFT 15 T3
1311.0520	80-AO 15 R	80	50	27	14	22	13	✓	9	r	AOFT 15 T3

Tool will be delivered with holder, all screws and screw-driver, but without indexable inserts.

Accessories / spare parts

Part No	Torx screw				Screw-driver	
	Qty	Article	Type	Torque	Article	Type
1311.0460	4	1490.0280	M3.5 x 7	2.55 Nm	1492.0500	T15
1311.0480	6	1490.0280	M3.5 x 7	2.55 Nm	1492.0500	T15
1311.0500	7	1490.0280	M3.5 x 7	2.55 Nm	1492.0500	T15
1311.0520	9	1490.0280	M3.5 x 7	2.55 Nm	1492.0500	T15



ALESA TWIST: the patented spiral ground indexable insert for a smooth and vibration-free chip removal for any metals. The full cutting edge is useable (ap).



Highly positive, extremely sharp cutting edge of HSS-E and carbide.



When milling slots with an internal cooling system set operating pressure above 20 bar. Ensure clear chip removal.



Stainless steels (V2A) can be machined dry with AlCrN coated inserts.



Profile milling



Slot milling



Face milling

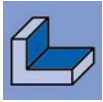

ALESA TWIST milling cutter

AO 15 R 90° / Ø 40 - 80

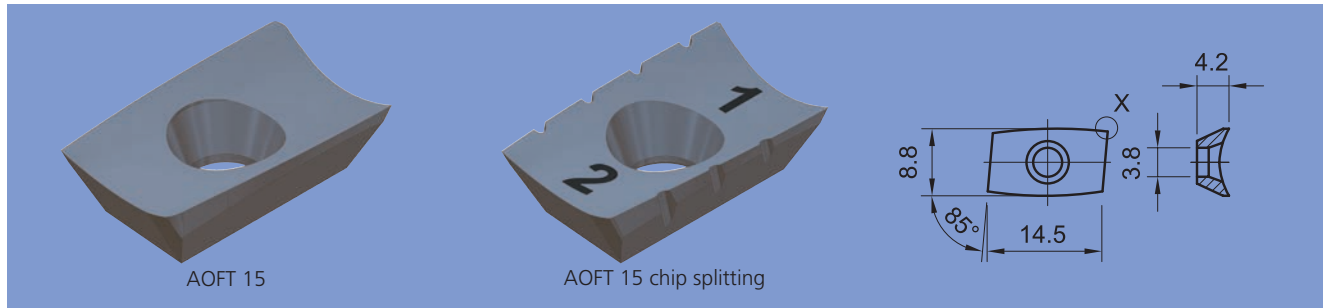

Profile milling

Cutting material	Coating	Part No	ISO Code	Detail X				Werkstoffklassen					
								1	2	3	4	5	6
HSS-E	TiN	1087.0190	AOFT 15 T3 PF FR	0.2x45°	r	●		○	○		●		●
		1087.0210	AOFT 15 T3 08 FR	R 0.8	r	●		○	○		●		●
	TiAlN	1162.0190	AOFT 15 T3 PF FR	0.2x45°	r	●		○	●		●	○	●
		1162.0210	AOFT 15 T3 08 FR	R 0.8	r	●		○	●		●	○	●
HSS-E chip splitting °)	TiN	1087.0505	AOFT 15 T3 PF FR (No 1/2)	0.2x45°	r	●		○	○		●		●
		1087.0508	AOFT 15 T3 PF FR (No 3)	0.2x45°	r	●		○	○		●		●
Carbide HM	TiN	1287.0210	AOFT 15 T3 PF FR-411	0.2x45°	r	●	○	○	○	●	●		●
		1287.0215	AOFT 15 T3 08 FR-411	R 0.8	r	●	○	○	○	●	●		●
	TiAlN	1287.0310	AOFT 15 T3 PF FR-411	0.2x45°	r	●	○	○	○	●	●		●
		1287.0315	AOFT 15 T3 08 FR-411	R 0.8	r	●	○	○	○	●	●		●
	AlCrN	1287.0661	AOFT 15 T3 PF FR-421	0.2x45°	r	●	○	○	○	●	●	○	●
		1287.0666	AOFT 15 T3 08 FR-421	R 0.8	r	●	○	○	○	●	●	○	●
		1287.0667	AOFT 15 T3 08 FR-431	R 0.8	r	●	○	○	○	●	○	○	●
		1287.0669	AOFT 15 T3 12 FR-421	R 1.2	r	●	○	○	○	●	○	○	●
	AlCrN-VA	1287.0671	AOFT 15 T3 16 FR-421	R 1.6	r	●	○	○	○	●	○	○	●
		1287.0673	AOFT 15 T3 20 FR-421	R 2.0	r	●	○	○	○	●	○	○	●
	DLC-H	1287.0767	AOFT 15 T3 08 FR-431	R 0.8	r	●	○	○	○	●	○	○	●
		1287.0916	AOFT 15 T3 08 FR-421	R 0.8	r	●	○	○	○	●	○	○	●
Carbide HM-F	TiAlN	1287.0510	AOFT 15 T3 PF FR-511	0.2x45°	r		●	○	○	●			●
		1287.0515	AOFT 15 T3 08 FR-511	R 0.8	r		●	○	○	●			●
	AlCrN	1287.0711	AOFT 15 T3 PF FR-521	0.2x45°	r		●	○	○	●	○		●
		1287.0716	AOFT 15 T3 08 FR-521	R 0.8	r		●	○	○	●	○		●
	AlCrN-VA	1287.0717	AOFT 15 T3 08 FR-531	R 0.8	r		●	○	○	●	○		●
		1287.0817	AOFT 15 T3 08 FR-531	R 0.8	r		●	○	○	●	○		●
DLC-H	1287.0967	AOFT 15 T3 08 FR-531	R 0.8	r		●	○	○	●	○		●	
Carbide HA	AlCrN-VA	1289.0232	AOFT 15 T3 08 FR-631	R 0.8	r	●	○	○	○	●		○	●

°) Order of inserts with chip splitting see page 136
Fitting instructions for inserts see page 136

Zusatznummer Wendeschneidplatten ISO-Code (Schneidengeometrie)
Additional number indexable inserts ISO-code (cutting geometry)
Numéro supplémentaire plaquettes amovibles code ISO (géométrie de coupe)

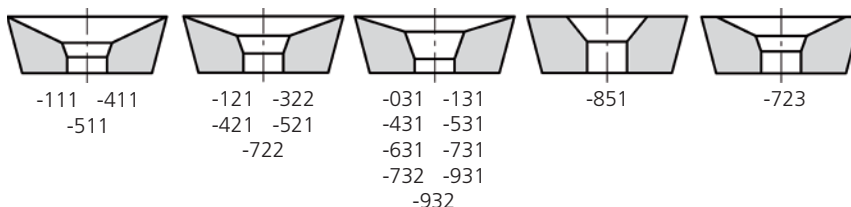

Overview of all indexable inserts see page 106 and following.

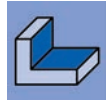

ALESA TWIST Coolex milling cutter

AO 15 R 90° / Ø 40 - 63

1340 - 15

Profile milling



Part No	Type	D mm	H mm	d1 mm	d2 mm	l1 mm	ap mm				WSP
1340.0462	40-AO 15 Coolex	40	32	16	8.5	18	13	✓	4	r	AOFT 15 T3
1340.0482	50-AO 15 Coolex	50	40	22	11	20	13	✓	5	r	AOFT 15 T3
1340.0502	63-AO 15 Coolex	63	40	22	11	20	13	✓	6	r	AOFT 15 T3

Tool will be delivered with holder, all screws and screw-driver, but without indexable inserts.

Special spare parts for ALESA TWIST Coolex AO15:

No 1489.0462 Hydroschild / No 1491.0220 Screw M2.5x5 for hydroschild / No 1493.0300 Screw-driver TP 7 IP

How to remove the hydroschild

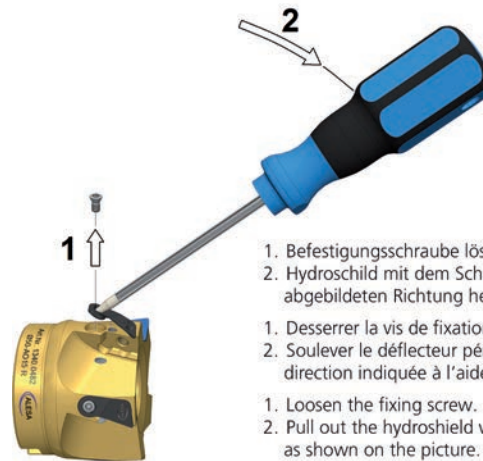

1. Befestigungsschraube lösen.
 2. Hydroschild mit dem Schraubendreher in der abgebildeten Richtung herauskippen.
1. Desserrer la vis de fixation.
 2. Soulever le déflecteur périphérique dans la direction indiquée à l'aide du tourne-vis.
1. Loosen the fixing screw.
 2. Pull out the hydroschild with the screwdriver as shown in the picture.

Part No	Torx screw				Screw-driver		Hex socket head screw		
	Qty	Article	Type	Torque	Article	Type	Article	Type	Torque
1340.0462	4	1490.0280	M3.5 x 7	2.55 Nm	1492.0500	T15	1490.0759	M8 x 20	30 Nm
1340.0482	6	1490.0280	M3.5 x 7	2.55 Nm	1492.0500	T15	1490.0770	M10 x 25	50 Nm
1340.0502	6	1490.0280	M3.5 x 7	2.55 Nm	1492.0500	T15	1490.0770	M10 x 25	50 Nm

Info

Innovative cooling / lubricating solution over the relive face. ALESA recommendation for material classification 5 together with "631" inserts. Internal coolant pressure up to 70 bar.



ALESA TWIST: the patented spiral ground indexable insert for a smooth and vibration-free chip removal for any metals. The full cutting edge is useable (ap).



When milling slots with an internal cooling system set operating pressure above 20 bar. Ensure clear chip removal.



Profile milling



Slot milling



Face milling

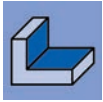

ALESA TWIST Coolex milling cutter

AO 15 R 90° / Ø 40 - 63

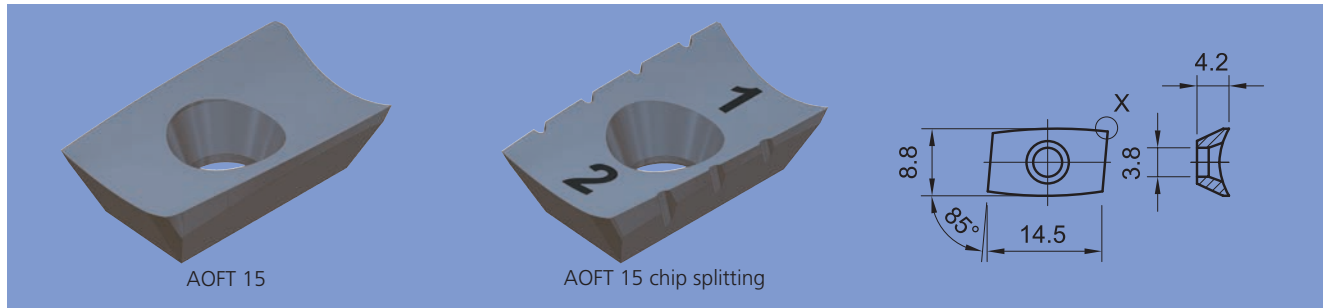

Profile milling

Cutting material	Coating	Part No	ISO Code	Detail X				Werkstoffklassen					
								1	2	3	4	5	6
HSS-E	TiN	1087.0190	AOFT 15 T3 PF FR	0.2x45°	r	●		○	○		●		●
		1087.0210	AOFT 15 T3 08 FR	R 0.8	r	●		○	○		●		●
	TiAlN	1162.0190	AOFT 15 T3 PF FR	0.2x45°	r	●		○	●		●	○	●
		1162.0210	AOFT 15 T3 08 FR	R 0.8	r	●		○	●		●	○	●
HSS-E chip splitting °)	TiN	1087.0505	AOFT 15 T3 PF FR (No 1/2)	0.2x45°	r	●		○	○		●		●
		1087.0508	AOFT 15 T3 PF FR (No 3)	0.2x45°	r	●		○	○		●		●
Carbide HM	TiN	1287.0210	AOFT 15 T3 PF FR-411	0.2x45°	r	●	○	○	○	●	●		●
		1287.0215	AOFT 15 T3 08 FR-411	R 0.8	r	●	○	○	○	●	●		●
	TiAlN	1287.0310	AOFT 15 T3 PF FR-411	0.2x45°	r	●	○	○	○	●	●		●
		1287.0315	AOFT 15 T3 08 FR-411	R 0.8	r	●	○	○	○	●	●		●
	AlCrN	1287.0661	AOFT 15 T3 PF FR-421	0.2x45°	r	●	○	○	○	●	●	○	●
		1287.0666	AOFT 15 T3 08 FR-421	R 0.8	r	●	○	○	○	●	●	○	●
		1287.0667	AOFT 15 T3 08 FR-431	R 0.8	r	●	○	○	○	●	○	○	○
		1287.0669	AOFT 15 T3 12 FR-421	R 1.2	r	●	○	○	○	●	●	○	●
	AlCrN-VA	1287.0671	AOFT 15 T3 16 FR-421	R 1.6	r	●	○	○	○	●	●	○	●
		1287.0673	AOFT 15 T3 20 FR-421	R 2.0	r	●	○	○	○	●	●	○	●
	DLC-H	1287.0767	AOFT 15 T3 08 FR-431	R 0.8	r	●	○	○	○	●	○	○	○
		1287.0916	AOFT 15 T3 08 FR-421	R 0.8	r	●	○	○	○	○	○	○	○
Carbide HA	AlCrN-VA	1289.0232	AOFT 15 T3 08 FR-631	R 0.8	r	●	○	○	○	○	○	○	

°) Order of inserts with chip splitting see page 136
Fitting instructions for inserts and 'how to remove the hydroshield' see page 136

Zusatznummer Wendeschneidplatten ISO-Code (Schneidengeometrie)
Additional number indexable inserts ISO-code (cutting geometry)
Numéro supplémentaire plaquettes amovibles code ISO (géométrie de coupe)

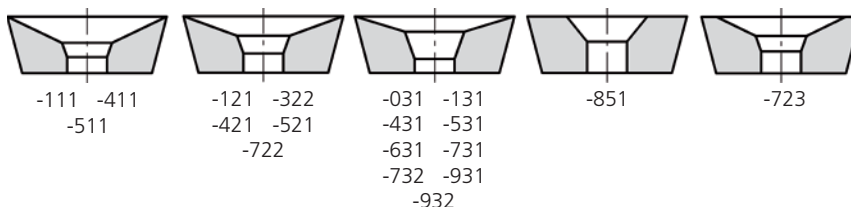

Overview of all indexable inserts see page 106 and following.

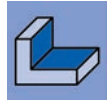

ALESA TWIST milling cutter

AO 20 R 90° / Ø 50 - 100

1312

Profile milling

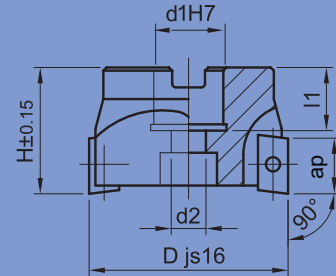
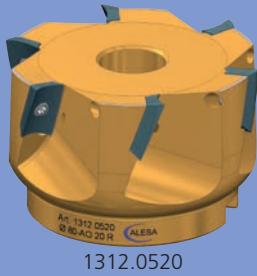

Part No	Type	D mm	H mm	d1 mm	d2 mm	l1 mm	ap mm				WSP
1312.0480	50-AO 20 R	50	40	22	11	20	17.5	✓	4	r	AOFT 20 04
1312.0500	63-AO 20 R	63	40	22	11	20	17.5	✓	5	r	AOFT 20 04
1312.0520	80-AO 20 R	80	50	27	14	22	17.5	✓	6	r	AOFT 20 04
1312.0540	100-AO 20 R	100	50	32	18	25	17.5	✓	7	r	AOFT 20 04

Tool will be delivered with holder, all screws and screw-driver, but without indexable inserts.

Part No	Torx screw				Screw-driver		Hex socket head screw		
	Qty	Article	Type	Torque	Article	Type	Article	Type	Torque
1312.0480	4	1490.0360	M4 x10	3.85 Nm	1492.0500	T15	1492.0770	M10 x 25	50 Nm
1312.0500	5	1490.0360	M4 x 10	3.85 Nm	1492.0500	T15	1490.0770	M10 x 25	50 Nm
1312.0520	6	1490.0360	M4 x 10	3.85 Nm	1492.0500	T15	1490.0780	M12 x 30	90 Nm
1312.0540	7	1490.0360	M4 x 10	3.85 Nm	1492.0500	T15	1490.0789	M16 x 30	160 Nm



ALESA TWIST: the patented spiral ground indexable insert for a smooth and vibration-free chip removal for any metals. The full cutting edge is useable (ap).



Highly positive, extremely sharp cutting edge of HSS-E and carbide.



When milling slots with an internal cooling system set operating pressure above 20 bar. Ensure clear chip removal.



Stainless steels (V2A) can be machined dry with AlCrN coated inserts.



Profile milling



Slot milling



Face milling

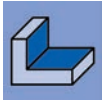

ALESA TWIST milling cutter

AO 20 R 90° / Ø 50 - 100

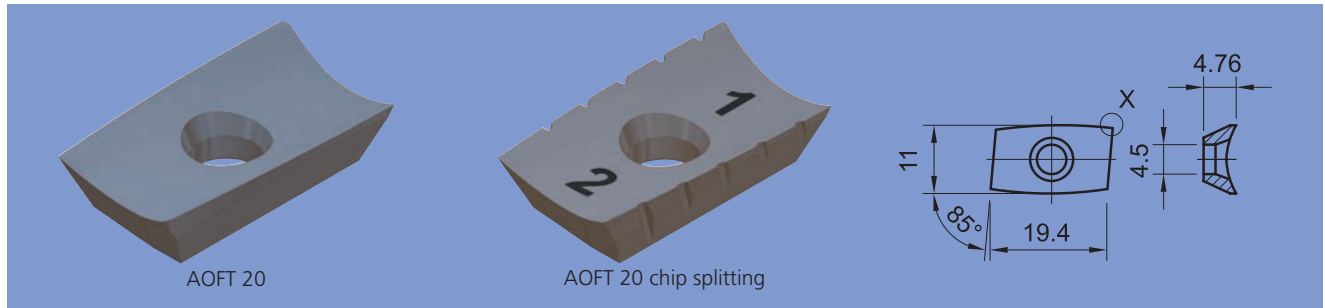

Profile milling

Cutting material	Coating	Part No	ISO Code	Detail X				Werkstoffklassen					
								1	2	3	4	5	6
HSS-E	TiN	1087.0215	AOFT 20 04 PF FR	0.2x45°	r	●		○	○		●		●
		1087.0315	AOFT 20 04 08 FR	R 0.8	r	●		○	○		●		●
	TiAlN	1162.0215	AOFT 20 04 PF FR	0.2x45°	r	●		○	●		●	○	●
		1162.0315	AOFT 20 04 08 FR	R 0.8	r	●		○	●		●	○	●
HSS-E chip splitting °)	TiN	1087.0515	AOFT 20 04 PF FR (No 1/2)	0.2x45°	r	●		○	○		●		●
		1087.0518	AOFT 20 04 PF FR (No 3)	0.2x45°	r	●		○	○		●		●
Carbide HM	TiN	1287.0225	AOFT 20 04 PF FR-411	0.2x45°	r	●	○	○	○	●	●		●
		1287.0230	AOFT 20 04 08 FR-411	R 0.8	r	●	○	○	○	●	●		●
	TiAlN	1287.0325	AOFT 20 04 PF FR-411	0.2x45°	r	●	○	○	○	●	●		●
		1287.0330	AOFT 20 04 08 FR-411	R 0.8	r	●	○	○	○	●	●		●
		AlCrN	1287.0676	AOFT 20 04 PF FR-421	0.2x45°	r	●	○	●	●	●	●	○
	1287.0681		AOFT 20 04 08 FR-421	R 0.8	r	●	○	●	●	●	●	○	●
	AlCrN-VA	1287.0682	AOFT 20 04 08 FR-431	R 0.8	r	●	○	●	●	○	○	○	○
1287.0782		AOFT 20 04 08 FR-431	R 0.8	r	●	○	●	○	○	○	○	○	
Carbide HM-F	TiAlN	1287.0525	AOFT 20 04 PF FR-511	0.2x45°	r		●	○	○	●			●
		1287.0530	AOFT 20 04 08 FR-511	R 0.8	r		●	○	○	●			●
	AlCrN	1287.0726	AOFT 20 04 PF FR-521	0.2x45°	r		●	●	●	●			●
		1287.0731	AOFT 20 04 08 FR-521	R 0.8	r		●	●	●	●			●
		1287.0735	AOFT 20 04 08 FR-531	R 0.8	r		●	●	○				
AlCrN-VA	1287.0835	AOFT 20 04 08 FR-531	R 0.8	r		●	●	○					
Carbide HA	AlCrN-VA	1289.0262	AOFT 20 04 08 FR-631	R 0.8	r	●	○	○	●			●	

°) Order of inserts with chip splitting see page 136
Fitting instructions for inserts see page 136

Zusatznummer Wendeschneidplatten ISO-Code (Schneidengeometrie)
Additional number indexable inserts ISO-code (cutting geometry)
Numéro supplémentaire plaquettes amovibles code ISO (géométrie de coupe)

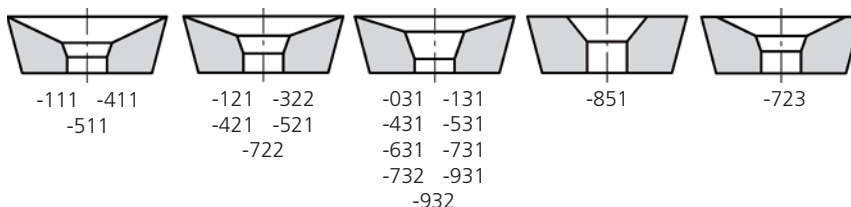

Overview of all indexable inserts see page 106 and following.

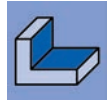

ALESA end mill AP

AP 16 R 90° / Ø 25 - 40

1345

Profile milling



1345.0420

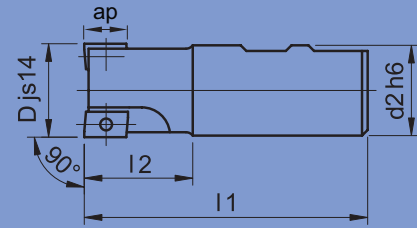

Part No	Type	D mm	l2 mm	d2 mm	l1 mm	ap mm				WSP
1345.0380	25-AP 16 R	25	38	25	96	16	✓	2	r	AP.T 16 04
1345.0420	32-AP 16 R	32	38	32	100	16	✓	3	r	AP.T 16 04
1345.0460	40-AP 16 R	40	48	32	110	16	✓	4	r	AP.T 16 04

*while stocks last

Tool will be delivered with holder, all screws and screw-driver, but without indexable inserts.

Accessories / spare parts

Part No	Torx screw				Screw-driver	
	Qty	Article	Type	Torque	Article	Type
1345.0380	2	1490.0320	M4 x 6	3.85 Nm	1492.0500	T15
1345.0420	3	1490.0360	M4 x 10	3.85 Nm	1492.0500	T15
1345.0460	4	1490.0360	M4 x 10	3.85 Nm	1492.0500	T15



Highly positive, extremely sharp cutting edge of HSS-E and carbide.



Holes for internal coolant supply guarantee ideal cooling.



Stainless steels (V2A) can be machined dry with AlCrN coated inserts.



Profile milling



Slot milling



Face milling

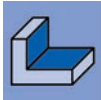

ALESA end mill AP

AP 16 R 90° / Ø 25 - 40

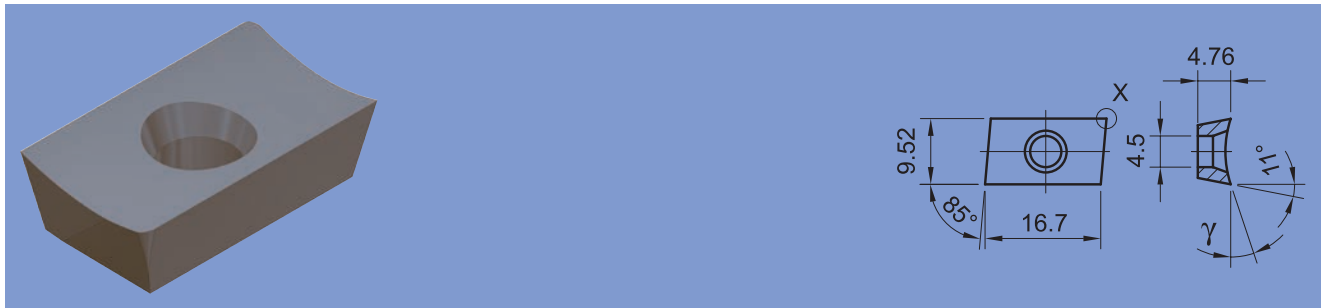

Profile milling

Cutting material	Coating	Part No	ISO Code	γ	Detail X				Werkstoffklassen					
									1	2	3	4	5	6
HSS-E	TiN	1085.0200	APFT 16 04 PD FR	18°	0.2x45°	r	●		○	○		●	●	
		1085.0230	APFT 16 04 PD FR	25°	0.2x45°	r	●		○	○		●	●	
		1085.0250	APFT 16 04 04 FR	18°	R 0.4	r	●		○	○		●	●	
		1085.0300	APFT 16 04 08 FR	18°	R 0.8	r	●		○	○		●	●	
		1085.0350	APFT 16 04 12 FR	18°	R 1.2	r	●		○	○		●	●	
	TiAlN	1160.0200	APFT 16 04 PD FR	18°	0.2x45°	r	●		○	●		●	○	●
		1160.0230	APFT 16 04 PD FR	25°	0.2x45°	r	●		○	●		●		●
		1160.0250	APFT 16 04 04 FR	18°	R 0.4	r	●		○	●		●	○	●
		1160.0300	APFT 16 04 08 FR	18°	R 0.8	r	●		○	●		●	○	●
		1160.0350	APFT 16 04 12 FR	18°	R 1.2	r	●		○	●		●	○	●
		Carbide MG20	TiN	1285.0200	APFT 16 04 PD FR-111	18°	0.2x45°	r	○	●	●	○		●
1285.0250	APFT 16 04 04 FR-111			18°	R 0.4	r	○	●	●	○		●	●	
TiAlN	1285.0300		APFT 16 04 08 FR-111	18°	R 0.8	r	○	●	●	○		●	●	
	1285.0205*		APFT 16 04 PD FR-111	18°	0.2x45°	r	○	●	●	○		●	●	
1285.0255*	APFT 16 04 04 FR-111		18°	R 0.4	r	○	●	●	○		●	●		
AlCrN	1285.0305*		APFT 16 04 08 FR-111	18°	R 0.8	r	○	●	●	○		●	●	
	1285.0215		APFT 16 04 PD FR-111	18°	0.2x45°	r	○	●	●	○		●	●	
	1285.0265		APFT 16 04 04 FR-111	18°	R 0.4	r	○	●	●	○		●	●	
	1285.0315		APFT 16 04 08 FR-111	18°	R 0.8	r	○	●	●	○		●	●	
AlCrN-VA	1285.0515*		APFT 16 04 PD FR-121	10°	0.2x45°	r	○	●	●	○	●	●	○	●
	1285.0615*		APFT 16 04 08 FR-121	10°	R 0.8	r	○	●	●	○	●	●	○	●
	1285.0520*		APFT 16 04 PD FR-121	10°	0.2x45°	r	○	●	●	○	●	●	○	●
	1285.0620		APFT 16 04 08 FR-121	10°	R 0.8	r	○	●	●	○	●	●	○	●
	Carbide 12CR		TiAlN	1285.0400*	APHT 16 04 PD FR-222	16°		r	●	●	○	●	○	●
		1285.0410*		APHT 16 04 PD FR-222	16°		r	●	●	○	●	○	●	○

Fitting instructions for inserts see page 136

*while stocks last

Zusatznummer Wendeschneidplatten ISO-Code (Schneidengeometrie)
 Additional number indexable inserts ISO-code (cutting geometry)
 Numéro supplémentaire plaquettes amovibles code ISO (géométrie de coupe)

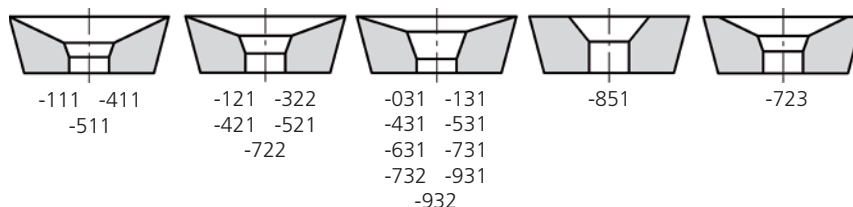

Overview of all indexable inserts see page 106 and following.

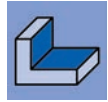

ALESA milling cutter AP

AP 16 R 90° / Ø 40 - 160

1310

Profile milling



1310.0520

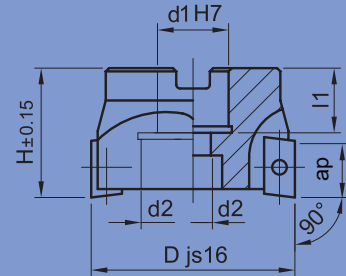

Part No	Type	D mm	H mm	d1 mm	d2 mm	l1 mm	ap mm				WSP
1310.0460	40-AP 16 R	40	32	16	8.5	18	16	✓	3	r	AP.T 16 04
1310.0480	50-AP 16 R	50	40	22	11	20	16	✓	4	r	AP.T 16 04
1310.0500	63-AP 16 R	63	40	22	11	20	16	✓	5	r	AP.T 16 04
1310.0520	80-AP 16 R	80	50	27	14	22	16	✓	6	r	AP.T 16 04
1310.0540	100-AP 16 R	100	50	32	18	25	16	✓	7	r	AP.T 16 04
1310.0560	125-AP 16 R	125	63	40	56	28	16		8	r	AP.T 16 04
1310.0580	160-AP 16 R	160	63	40	56	28	16		10	r	AP.T 16 04

*while stocks last

Tool will be delivered with holder, all screws and screw-driver, but without indexable inserts.

Part No	Torx screw				Screw-driver		Hex socket head screw		
	Qty	Article	Type	Torque	Article	Type	Article	Type	Torque
1310.0460	3	1490.0360	M4 x 10	3.85 Nm	1492.0500	T15	1490.0759	M8 x 20	30 Nm
1310.0480	4	1490.0360	M4 x 10	3.85 Nm	1492.0500	T15	1490.0770	M8 x 20	50 Nm
1310.0500	5	1490.0360	M4 x 10	3.85 Nm	1492.0500	T15	1490.0770	M10 x 25	50 Nm
1310.0520	6	1490.0360	M4 x 10	3.85 Nm	1492.0500	T15	1490.0780	M12 x 30	90 Nm
1310.0540	7	1490.0360	M4 x 10	3.85 Nm	1492.0500	T15	1490.0789	M16 x 30	160 Nm
1310.0560	8	1490.0360	M4 x 10	3.85 Nm	1492.0500	T15			
1310.0580	10	1490.0360	M4 x 10	3.85 Nm	1492.0500	T15			



Holes for internal coolant supply guarantee ideal cooling.



All ALESA indexable inserts are ground in the high ISO standard tolerance classification F.



Stainless steels (V2A) can be machined dry with AlCrN coated inserts.



Highly positive, extremely sharp cutting edge of HSS-E and carbide.



Profile milling



Slot milling



Face milling

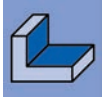

ALESA milling cutter AP

AP 16 R 90° / Ø 40 - 160



Profile milling

Cutting material	Coating	Part No	ISO Code	γ	Detail X				Werkstoffklassen					
									1	2	3	4	5	6
HSS-E	TiN	1085.0200	APFT 16 04 PD FR	18°	0.2x45°	r	●		○	○		●	●	
		1085.0230	APFT 16 04 PD FR	25°	0.2x45°	r	●		○	○		●	●	
		1085.0250	APFT 16 04 04 FR	18°	R 0.4	r	●		○	○		●	●	
		1085.0300	APFT 16 04 08 FR	18°	R 0.8	r	●		○	○		●	●	
		1085.0350	APFT 16 04 12 FR	18°	R 1.2	r	●		○	○		●	●	
	TiAlN	1160.0200	APFT 16 04 PD FR	18°	0.2x45°	r	●		○	●		●	○	●
		1160.0230	APFT 16 04 PD FR	25°	0.2x45°	r	●		○	●		●	○	●
		1160.0250	APFT 16 04 04 FR	18°	R 0.4	r	●		○	●		●	○	●
		1160.0300	APFT 16 04 08 FR	18°	R 0.8	r	●		○	●		●	○	●
		1160.0350	APFT 16 04 12 FR	18°	R 1.2	r	●		○	●		●	○	●
		Carbide MG20	TiN	1285.0200	APFT 16 04 PD FR-111	18°	0.2x45°	r	○	●	●	○		●
1285.0250	APFT 16 04 04 FR-111			18°	R 0.4	r	○	●	●	○		●	●	
TiAlN	1285.0300		APFT 16 04 08 FR-111	18°	R 0.8	r	○	●	●	○		●	●	
	1285.0205*		APFT 16 04 PD FR-111	18°	0.2x45°	r	○	●	●	○		●	●	
AlCrN	1285.0255*		APFT 16 04 04 FR-111	18°	R 0.4	r	○	●	●	○		●	●	
	1285.0305*		APFT 16 04 08 FR-111	18°	R 0.8	r	○	●	●	○		●	●	
	1285.0215		APFT 16 04 PD FR-111	18°	0.2x45°	r	○	●	●	○		●	●	
	1285.0265		APFT 16 04 04 FR-111	18°	R 0.4	r	○	●	●	○		●	●	
	1285.0315		APFT 16 04 08 FR-111	18°	R 0.8	r	○	●	●	○		●	●	
	1285.0515*		APFT 16 04 PD FR-121	10°	0.2x45°	r	○	●	●	○		●	●	
AlCrN-VA	1285.0615*		APFT 16 04 08 FR-121	10°	R 0.8	r	○	●	●	○		●	●	
	1285.0520*		APFT 16 04 PD FR-121	10°	0.2x45°	r	○	●	●	○		●	●	
	1285.0620		APFT 16 04 08 FR-121	10°	R 0.8	r	○	●	●	○		●	●	
	Carbide 12CR		TiAlN	1285.0400*	APHT 16 04 PD FR-222	16°		r	●	●	○	○	○	○
AlCrN		1285.0410*	APHT 16 04 PD FR-222	16°		r	●	●	○	○	○	○	○	

Fitting instructions for inserts see page 136

*while stocks last

Zusatznummer Wendeschneidplatten ISO-Code (Schneidengeometrie)
 Additional number indexable inserts ISO-code (cutting geometry)
 Numéro supplémentaire plaquettes amovibles code ISO (géométrie de coupe)

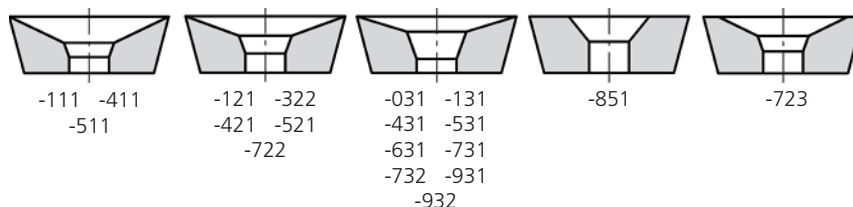

Overview of all indexable inserts see page 106 and following.

Hobbing

ALESA Delta

The characteristics

- THE new original of the high-positive, sharp-ground shell end-indexable insert cutters
- SWISS Precision Tool. The milling head and cutting inserts are manufactured in Switzerland
- Unique with 20° helix angle
- The peeling of the cutting process is very spindle and machine-friendly
- The sharp blades require less spindle power and the cutting forces are much smaller
- The ALESA tools are optimized for modern 5-axis milling centers
- All tools are provided with cooling holes. Optimum cooling, optimal evacuation of chips

The benefits and options for you

- Fast delivery from the Seengen warehouse
- There are different Ø ranges available
- Ø 25 mm and Ø 32 mm Weldon and also with screw head
- Ø 43 mm to Ø 83 mm as arbor milling cutter
- With various cutting-geometries a very large range of materials can be processed
- There are carbide qualities for the dry and wet machining
- High removal rate (Q) and large depth of cut with a relatively small machine load
- Good tool life and high productivity
- Excellent machining properties with the most difficult Ni-, Ti- and Co- alloys
- Manufactured according to ISO certified processes
- For special tools, our construction with great experience is available

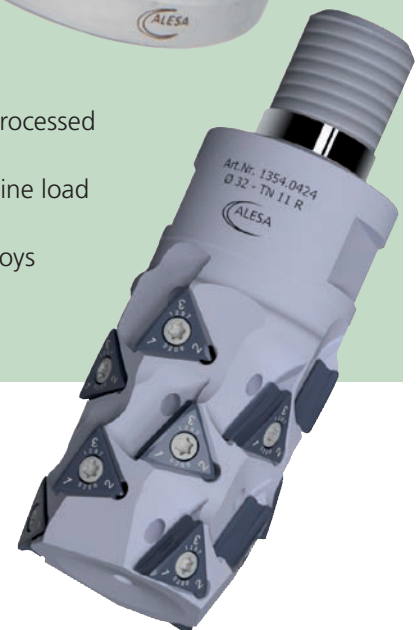

Hobbing

ALESA Delta

Comments on the application of shell-end mills

- Shell-end mills put heavy demands on spindle performance as well as on the stability of the tool holder and the clamping condition of parts
- Processing with vibration should be avoided
- The unequal division and the special ALESA spiral position of the cutting edges have a large influence on the cutting forces that occur
- Machine-friendly processes without oscillations and vibrations are the rule
- Choose tool holder to be as long as necessary and as short as possible
- In case of extensions, preferably select the tools with $\varnothing 43$ mm, $\varnothing 53$ mm, $\varnothing 66$ mm or $\varnothing 83$ mm, so that a potentially larger extension diameter can be used
- Preferably, use accurate holders! Circular and axial run-out errors have a much larger effect with shell end mills than with normal cutting tools
- Shell-end mills produce the best performance if $ae < 20\%$ of the tool diameter is used
- Watch out for adequate and stable pressure coolant supply when using cooling. The cooling demand is much higher than with normal cutting tools
- To tighten the center screw use torque wrenches!



Cutting and process data for shell-end mills

- Cutting speed and average chip thickness hm can be found in the ALESA catalog
- For shell-end mills, the $V_{c_{max}}$ in the slotting / face milling field « $ae = 50\% - 100\%$ » has to match the class of materials
- Calculate N_{max} and Vf_{max} in advance
- **IMPORTANT:**
If vibrations did occur, check the cutting insert bolts and if necessary tighten them again with the proper torque
- If cutting insert rows are not required, the cutting insert screws must be removed also
- For outer or inner circular processing the correct track speed « Vf » at the center of the milling machine must be calculated
- With outer and inner circular milling, several factors influence the actual cutting width « ae »
The large depth of cut with the shell-end mills causes large radial forces, which can also go up excessively in case of strong increase of the width of the cut:
The actual « ae » must therefore be calculated



ALESA DELTA shell end mill

TN 11 R 90° / Ø 25 - 32

1354

Hobbing



Part No	Type	D mm	l2 mm	d2 mm	G	l1 mm	ap mm				WSP
1354.0382	25-TN 11 R 3x4	25	38	25		96	30	✓	3 x 4	r	TN 11 S4
1354.0384	25-TN 11 R 2x4	25	52	12.5	M12	72	30	✓	2 x 4	r	TN 11 S4
1354.0422	32-TN 11 R 4x5	32	46	32		108	37	✓	4 x 5	r	TN 11 S4
1354.0424	32-TN 11 R 3x5	32	64	17	M16	86	37	✓	3 x 5	r	TN 11 S4

Tool will be delivered with holder, screws and screw-driver, but without indexable inserts.

Accessories / spare parts

Part No	Torx screw				Screw-driver	
	Qty	Article	Type	Torque	Article	Type
1354.0382	12	1490.0275	M3 x 8.2	1.8 Nm	1492.0450	T9
1354.0384	8	1490.0275	M3 x 8.2	1.8 Nm	1492.0450	T9
1354.0422	20	1490.0275	M3 x 8.2	1.8 Nm	1492.0450	T9
1354.0424	15	1490.0275	M3 x 8.2	1.8 Nm	1492.0450	T9



ALESA DELTA: the spiral ground indexable insert for a smooth and vibration-free chip removal for any metals.



Best results at ae 10 - 20% of the diameter.



Profile milling



ALESA DELTA shell end mill

TN 11 R 90° / Ø 25 - 32

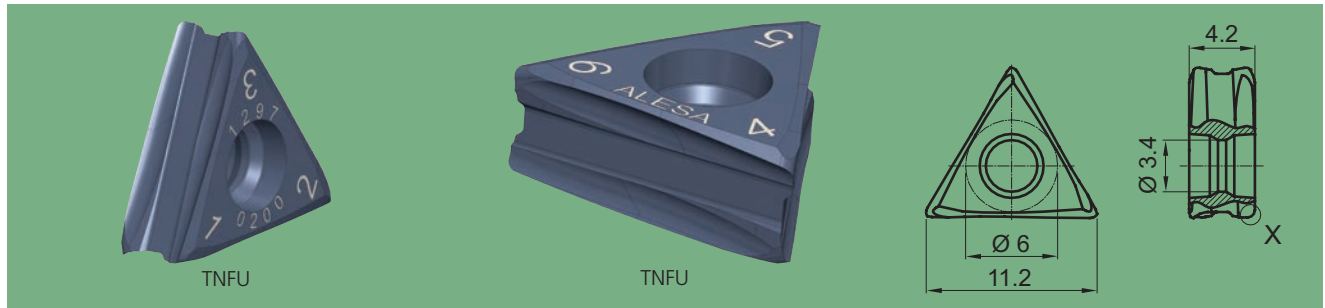

Hobbing

Cutting material	Coating	Part No	ISO Code	Detail X				Werkstoffklassen					
								1	2	3	4	5	6
Carbide CTS	AlCrN-VA	1297.0200	TNFU 11 S4 04 FR-321	R 0.4	r	●	○	●	○	○	○		
		1297.0650	TNFU 11 S4 PF FR-321	0.2x45°	r	●	○	●	○	○	○		
	DLC-H	1297.0201	TNFU 11 S4 04 FR-321	R 0.4	r	●	○	○	●	○	●		
		1297.0651	TNFU 11 S4 PF FR-321	0.2x45°	r	●	○	○	●	○	●		
Carbide CTS-X	TiNox	1297.0267	TNFU 11 S4 04 FR-731	R 0.4	r	●	○	○	○	○	○		
		1297.0717	TNFU 11 S4 PF FR-731	0.2x45°	r	●	○	○	○	○	○		
Carbide CTM	TiNox	1297.0317	TNFU 11 S4 04 FR-931	R 0.4	r	●	○	○	○	○	●		

Fitting instructions for inserts see page 136

Zusatznummer Wendeschneidplatten ISO-Code (Schneidengeometrie)
 Additional number indexable inserts ISO-code (cutting geometry)
 Numéro supplémentaire plaquettes amovibles code ISO (géométrie de coupe)

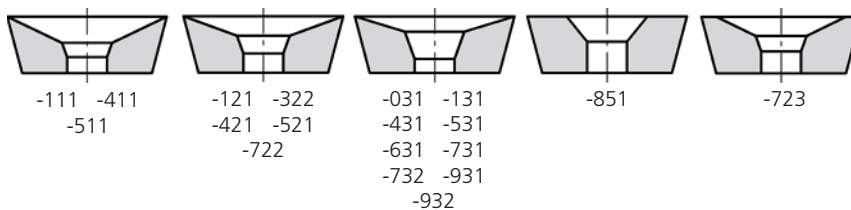

Overview of all indexable inserts see page 106 and following.



ALESA DELTA shell end mill

TN 18 R 90° / Ø 43 - 83

1354 / 1356

Hobbing



Part No	Type	D mm	H mm	d1 mm	d2 mm	l1 mm	ap mm				WSP
1354.0463	43-TN 11 R 5x5	43	60	16	8.5	18	37	✓	5 x 5	r	TNFU 11 S4
1356.0463	43-TN 18 R 3x3	43	60	16	8.5	18	36	✓	3 x 3	r	TNFU 18 07
1356.0483	53-TN 18 R 4x4	53	72	22	11	20	48	✓	4 x 4	r	TNFU 18 07
1356.0503	66-TN 18 R 5x5	66	85	27	14	22	60	✓	5 x 5	r	TNFU 18 07
1356.0523	83-TN 18 R 6x6	83	100	32	18	25	72	✓	6 x 6	r	TNFU 18 07

Tool will be delivered with holder, all screws and torque wrench, but without indexable inserts.

Part No	Torx screw				Screw-driver		Hex socket head screw		
	Qty	Article	Type	Torque	Article	Type	Article	Type	Torque
1354.0463	25	1490.0275	M3 x 8.2	1.8 Nm	1492.0450	T9	1490.0700	M8 x 50	30 Nm
1356.0463	9	1490.0385	M5 x 11.5	5 Nm	1492.0650	T20	1490.0700	M8 x 50	30 Nm
1356.0483	16	1490.0395	M5 x 14.5	5 Nm	1492.0650	T20	1490.0710	M10 x 60	50 Nm
1356.0503	25	1490.0395	M5 x 14.5	5 Nm	1492.0650	T20	1490.0728	M12 x 70	90 Nm
1356.0523	36	1490.0395	M5 x 14.5	5 Nm	1492.0650	T20	1490.0738	M16 x 80	160 Nm



ALESA DELTA: the spiral ground indexable insert for a smooth and vibration-free chip removal for any metals.



Best results at ae 10 - 20% of the diameter.



Profile milling



ALESA DELTA shell end mill

TN 18 R 90° / Ø 43 - 83

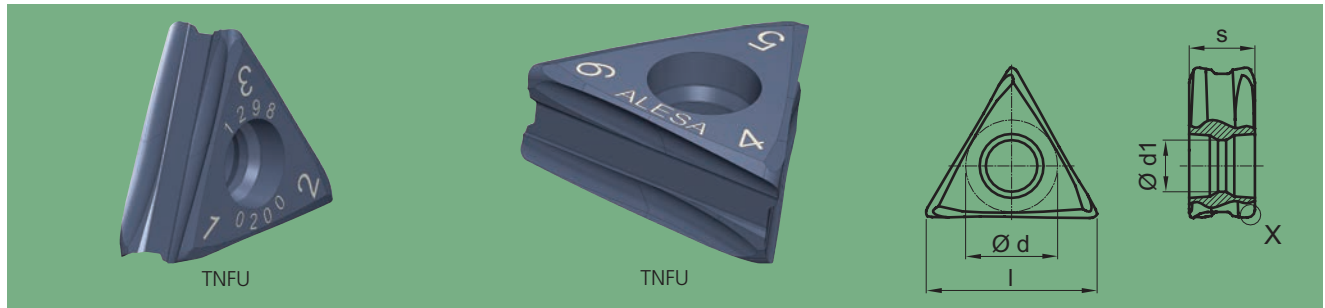

Hobbing

Cutting material	Coating	Part No	ISO Code	l mm	s mm	d mm	d1 mm	Detail X	🔥	✂️	Werkstoffklassen					
											1	2	3	4	5	6
Carbide CTS	AlCrN-VA	1297.0200	TNFU 11 S4 04 FR-321	11.2	4.2	6	3.4	R 0.4	●	○	●	○	○	○	○	
		1297.0650	TNFU 11 S4 PF FR-321	11.2	4.2	6	3.4	0.2x45°	●	○	●	○	○	○	○	
		1298.0200	TNFU 18 07 08 FR-321	18.3	7	9.8	5.5	R 0.8	●	○	●	○	○	○	○	
		1298.0650	TNFU 18 07 PF FR-321	18.3	7	9.8	5.5	0.2x45°	●	○	●	○	○	○	○	
	DLC-H	1297.0201	TNFU 11 S4 04 FR-321	11.2	4.2	6	3.4	R 0.4	●	○	○	○	●	●	○	
		1297.0651	TNFU 11 S4 PF FR-321	11.2	4.2	6	3.4	0.2x45°	●	○	○	○	●	●	○	
		1298.0201	TNFU 18 07 08 FR-321	18.3	7	9.8	5.5	R 0.8	●	○	○	○	●	●	○	
		1298.0651	TNFU 18 07 PF FR-321	18.3	7	9.8	5.5	0.2x45°	●	○	○	○	●	●	○	
Carbide CTS-X	TiNox	1297.0267	TNFU 11 S4 04 FR-731	11.2	4.2	6	3.4	R 0.4	●	○	○	●	○	○	○	
		1297.0717	TNFU 11 S4 PF FR-731	11.2	4.2	6	3.4	0.2x45°	●	○	○	●	○	○	○	
		1298.0267	TNFU 18 07 08 FR-731	18.3	7	9.8	5.5	R 0.8	●	○	○	●	○	○	○	
		1298.0717	TNFU 18 07 PF FR-731	18.3	7	9.8	5.5	0.2x45°	●	○	○	●	○	○	○	
Carbide CTM	TiNox	1297.0317	TNFU 11 S4 04 FR-931	11.2	4.2	6	3.4	R 0.4	●	○	○	○	○	●	○	
		1298.0317	TNFU 18 07 08 FR-931	18.3	7	9.8	5.5	R 0.8	●	○	○	○	○	●	○	
Carbide CTS-G	TiNox-G	1298.0318	TNFU 18 07 08 FR-031	18.3	7	9.8	5.5	R 0.8	○	●	○	○	○	○	○	

Fitting instructions for inserts see page 136

Zusatznummer Wendeschneidplatten ISO-Code (Schneidengeometrie)
 Additional number indexable inserts ISO-code (cutting geometry)
 Numéro supplémentaire plaquettes amovibles code ISO (géométrie de coupe)

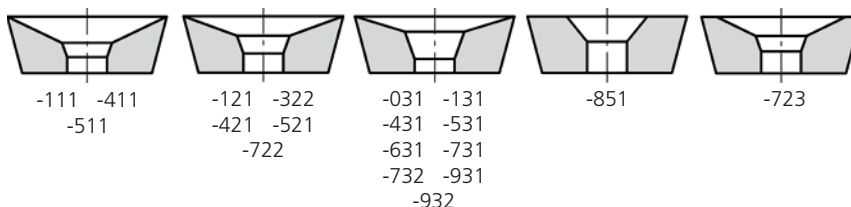

Overview of all indexable inserts see page 106 and following.

Fine finish milling

ALESA Delta adjustable

The characteristics

- Fine finishing tool based on the ALESA DELTA
- SWISS Precision Tool. The milling head and cutting inserts are manufactured in Switzerland
- Brilliantly simple setting system for adjusting the axial run-out
- Each insert can be axially adjusted to 0.001-0.002 mm (1-2 μm) be adjusted
- The fine finishing cutting inserts have a finishing edge
- The spiral angle of 20° means that the tools have a positive axial rake angle
- The sharp cutting produces a very small cutting force
Prerequisite for accuracy
- The unequal division is minimizing vibrations
- All tools are provided with cooling holes. During finishing, the cooling affects the surface quality significantly
- Various carbide grades and coatings are available



The benefits and options for you

- Fast delivery from the Seengen warehouse
- Arbor milling cutter \varnothing 43 mm to \varnothing 125 mm
- The optimized cutting geometries with fine finishing edge produce surfaces with Ra 0.3 - 0.4 (N5)
- High surface accuracy even when interrupted cutting
- Good tool life and high productivity
- Adjustability of the cutting inserts is also helpful to correct deviations for extensions
- Highest accuracy for guide and support surfaces
- Manufactured according to ISO certified processes
- For special tools, our construction with large experience is available

Fine finish milling



see ALESA
catalog «NUTEX»

ALESA NUTEX Plan

The characteristics

- Fine finishing tool based on the carbide Nutex Plus tool system
- All the teeth are ground in one setting, resulting in high accuracy
- Sharp ground cutting edges, with small cutting forces and good chip formation
- Positive cutting geometry in the axial direction also
- AlCrN PVD coating of the latest technology
- Very stable holders, based on the Nutex Plus System
- Internal coolant supply from both sides

The benefits and options for you

- Fast delivery from the Seengen warehouse
- Level finishing tools are available in the Ø 50 mm Ø 63 mm with a width of 6 mm
- Large numbers of teeth Z=16 and Z=18, relatively high feed rates, short finish times
- Nutex finishing tools can be re-sharpened

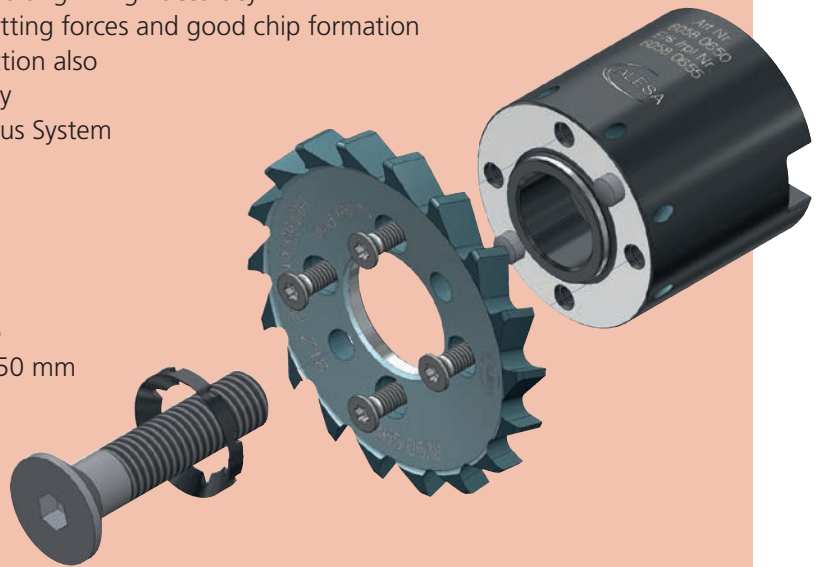

Fine finish milling

ALESA NUTEX Faset



see deburrer in the
Solid Carbide Tools
Catalogue

The characteristics

- 45° deburring tool based on the carbide Nutex Mini tool system
- The work of deburring can be improved significantly with the ALESA Nutex Faset

The benefits and options for you

- Fast delivery from the Seengen warehouse
- Two holders are available (M6 and shaft)
- The small prism tool fits the Nutex mini holders
- Available Ø 16 x 4.5 with Z = 10, coating AlCrN
- It can be manufactured up to 2 x 45° chamfering



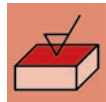

ALESA DELTA milling cutter adjustable

TN 18 - R/e 90° / Ø 43 - 125

1304e

Fine finish milling

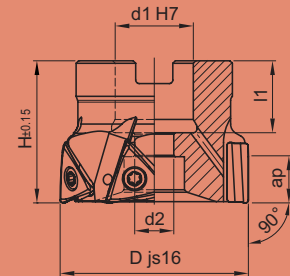

Part No	Type	D mm	H mm	d1 mm	d2 mm	l1 mm				WSP
1304.0465	43-TN 18 R/e	43	32	16	8.5	18	✓	4	r	TNFU 18 07
1304.0485	53-TN 18 R/e	53	40	22	11	20	✓	6	r	TNFU 18 07
1304.0505	66-TN 18 R/e	66	40	22	11	20	✓	7	r	TNFU 18 07
1304.0525	83-TN 18 R/e	83	50	27	14	22	✓	9	r	TNFU 18 07
1304.0545	103-TN 18 R/e	103	50	32	18	25	✓	10	r	TNFU 18 07
1304.0564	125-TN 18 R/e	125	63	40	22	29	✓	12	r	TNFU 18 07

Tool will be delivered with holder, all screws and torque wrench, but without indexable inserts.

Accessories

- No 1490.0270 Adjusting screw
- No 1492.0400 Screw-driver

Part No	Torx screw				Screw-driver		Hex socket head screw		
	Qty	Article	Type	Torque	Article	Type	Article	Type	Torque
1304.0465	6	1490.0395	M5 x 14.5	5 Nm	1492.0650	T20	1490.0770	M10 x 25	30 Nm
1304.0485	6	1490.0395	M5 x 14.5	5 Nm	1492.0650	T20	1490.0770	M10 x 25	30 Nm
1304.0505	7	1490.0395	M5 x 14.5	5 Nm	1492.0650	T20	1490.0770	M10 x 25	50 Nm
1304.0525	9	1490.0395	M5 x 14.5	5 Nm	1492.0650	T20	1490.0780	M12 x 30	90 Nm
1304.0545	10	1490.0395	M5 x 14.5	5 Nm	1492.0650	T20	1490.0789	M16 x 30	160 Nm
1304.0564	12	1490.0395	M 5 x 14.5	5 Nm	1492.0650	T20	1490.0800	M 20 x 40	230 Nm



For a surface quality of Ra < 0.4 µm (N5) when finishing.



Highly positive, extremely sharp cutting edge of carbide.



Face milling

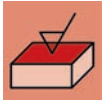

ALESA DELTA milling cutter adjustable

TN 18 - R/e 90° / Ø 43 - 125

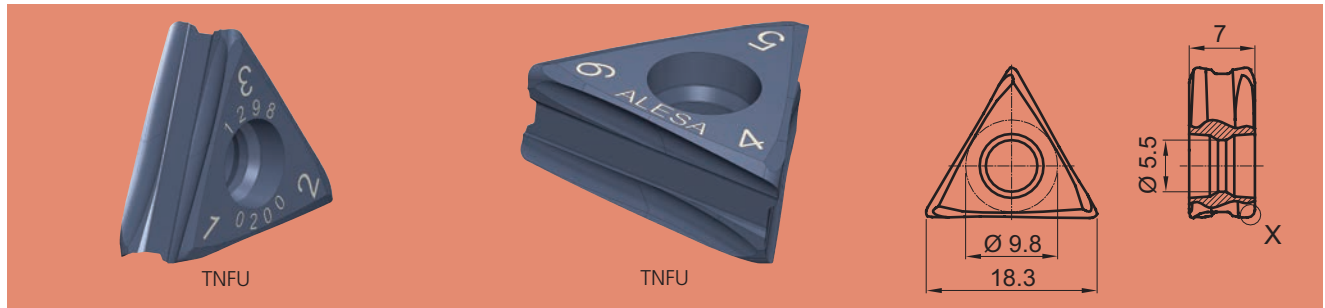

Fine finish milling

Cutting material	Coating	Part No	ISO Code	Detail X				Material classes					
								1	2	3	4	5	6
Carbide CTS	AICrN-VA	1298.0200	TNFU 18 07 08 FR-321	R 0.8	r	●	○	●	○	○	○		
	DLC-H	1298.0201	TNFU 18 07 08 FR-321	R 0.8	r	●	○	○	●	○	●		
Carbide CTS-X	TiNox	1298.0267	TNFU 18 07 08 FR-731	R 0.8	r	●	○	○	○	○	○		
Carbide CTM	TiNox	1298.0317	TNFU 18 07 08 FR-931	R 0.8	r	●	○	○	○	○	○		
Carbide CTS-G	TiNox-G	1298.0318	TNFU 18 07 08 FR-031	R 0.8	r	○	○	○	○	○	○		

Assembly and adjustment instructions for Alesa Delta milling head adjustable

Basically the fine adjustment allows a maximum adjustment of 40 µm! We therefore recommend going back to the basic settings regularly.

Basic setting: (milling head mounted on tool holder)

- Carefully clean the support and pocket surfaces of the insert and milling head. Lightly grease the screws if necessary.
- Loosen the adjusting screws (AJS) until the screws can move freely.
- Mount indexable inserts and tighten the insert screws (INS) with a torque screwdriver T20 with 5Nm.
- Screw in the AJS with a T9 screwdriver until you feel a slight resistance.
- Measure and record the height of each insert on the tool presetter.
- The "basic setting" is only carried out when the INS are released. The highest insert corner is raised by a maximum of 5µm. All other insert corners are adjusted to the same height (within approx. 5µm).
A half (½) turn of the AJS corresponds to about 10-12µm height adjustment.
Before measuring the height, tighten the INS again with 5Nm.
- A first cut is milled with this basic setting.
Only then is the fine adjustment made to 1µm - 2µm.
The result can only be achieved if the setting is made directly in the machine spindle. We recommend using a large flat stylus (not a ball).

Fine adjustment: 1µm dial indicator

If the height difference is less than 5 µm, the inserts can be readjusted without loosening the INS. Otherwise the INS must be released. This Step must be carried out individually on each machine spindle.

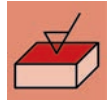

ALESA TWIST milling cutter adjustable

AO 15 R/e 90° / Ø 40 - 125

1311e

Fine finish milling



1311.0504

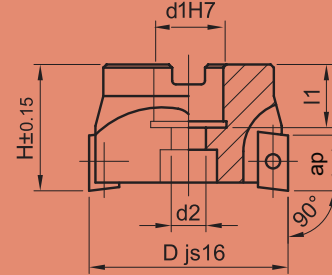

Part No	Type	D mm	H mm	d1 mm	d2 mm	l1 mm	ap mm				WSP
1311.0464*	40-AO 15 R/e	40	32	16	8.5	18	2	✓	4	r	1287.0718
1311.0484*	50-AO 15 R/e	50	40	22	11	20	2	✓	6	r	1287.0719
1311.0504*	63-AO 15 R/e	63	40	22	11	20	2	✓	7	r	1287.0719
1311.0524*	80-AO 15 R/e	80	50	27	14	22	2	✓	9	r	1287.0720
1311.0544*	100-AO 15 R/e	100	50	32	18	25	2	✓	10	r	1287.0720
1311.0564*	125-AO 15 R/e	125	63	40	22	29	2	✓	12	r	1287.0720

*while stocks last

Tool will be delivered with holder, all screws and screw-driver, but without indexable inserts.

Accessories

No 1490.0270 Adjusting screw

No 1492.0400 Screw-driver

Part No	Torx screw				Screw-driver		Hex socket head screw		
	Qty	Article	Type	Torque	Article	Type	Article	Type	Torque
1311.0464	4	1490.0280	M3.5 x 7	2.55 Nm	1492.0500	T15	1490.0759	M8 x 20	30 Nm
1311.0484	6	1490.0280	M3.5 x 7	2.55 Nm	1492.0500	T15	1490.0770	M10 x 25	50 Nm
1311.0504	7	1490.0280	M3.5 x 7	2.55 Nm	1492.0500	T15	1490.0770	M10 x 25	50 Nm
1311.0524	9	1490.0280	M3.5 x 7	2.55 Nm	1492.0500	T15	1490.0780	M12 x 30	90 Nm
1311.0544	10	1490.0280	M3.5 x 7	2.55 Nm	1492.0500	T15	1490.0789	M16 x 30	160 Nm
1311.0564	12	1490.0280	M3.5 x 7	2.55 Nm	1492.0500	T15	1490.0800	M20 x 40	210 Nm



For a surface quality of Ra < 0.4 µm (N5) when finishing.



Highly positive, extremely sharp ground cutting tool with level finishing edge.



Face milling

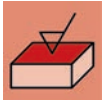

ALESA TWIST milling cutter adjustable

AO 15 R/e 90° / Ø 40 - 125



Fine finish milling

Cutting material	Coating	Part No	ISO Code	Detail X				Werkstoffklassen					
								1	2	3	4	5	6
Carbide HM-F	AlCrN	1287.0718	AOFT 15 T3 08 FR-521/40	R 0.8	r	○	●	●	●	●	○	○	○
		1287.0719	AOFT 15 T3 08 FR-521/50/63	R 0.8	r	○	●	●	●	●	○	○	○
		1287.0720	AOFT 15 T3 08 FR-521/80-125	R 0.8	r	○	●	●	●	●	○	○	○

Fitting instructions for inserts see page 136

Overview of all indexable inserts see page 106 and following.

Face milling 45°

ALESA Hepta

The characteristics

- .. us de Schwiiz! All milling cutter tools as well as the indexable inserts are designed and manufactured in Switzerland.
- The 45° HEPTA face milling tools are equipped with double sided indexable inserts with total 14 cutting edges (2x7).
- The high amount of cutting edges are a guarantee for an excellent price-performance ratio.
- The sharp ground edges require less spindle power and are process friendly.
- The dovetail shape positioning of the HEPTA indexable inserts into the tool bodies are very process secure.
- The shape of the tool body and the indexable inserts are a unit. The basic design of the indexable inserts protects the cutting edges on the back side while milling.
- The HEPTA tools have straight cutting edges with the effect of exact 45° chamfers.
- Each edge has a ground smooth phase for high quality surfaces.
- The uneven pitch together with the peeling cutting process and a good balancing are ideal circumstances for milling processes on 5-axis machine centers.
- All HEPTA tools are provided with internal holes for coolant supply.
- HEPTA indexable inserts have a large contact area with the tool body. This enables a good heat transfer and thermal stability even under dry machining processes.



The benefits and options for you

- The HEPTA indexable inserts XOFU 06 are for cutting depth (ap) up to 4 mm.
- The milling cutters XO 06 are shell mills available in Ø 40 mm – Ø 160 mm.
- We recommend the PVD coated indexable inserts for following application: Carbide CTS with AlCrN-VA for material classification (MC) 1 (steel) and MC 3 (cast alloys). Carbide CTS-X / TiNox for MC 2 (stainless steel) and MC 5 (Ni- / Ti- / Co-based alloys), for Duplex- and Super-Duplex alloys.
- All HEPTA indexable inserts allow dry or wet machining.
- Based on the design and basic cutting technology, HEPTA tools should NOT be used within ae (radial engagement) range 40% to 60%.
- Best milling results can be achieved in MC 2 & 5 if ae < 35%.
- For special tools, our construction with great experience is available.



Face milling 45°

ALESA SD09 / SD12

The characteristics

- THE classic of the 45° face cutting insert tools with SD screw-in cutting inserts
- From ALESA with high positive, sharp-ground inserts
- SWISS Precision Tool. The milling head and cutting inserts are manufactured in Switzerland
- Robust and proven solution according to DIN
- The sharp blades require less spindle power than pure sintered cutting inserts
- The sharp-ground cutting inserts are optimized for modern 5-axis milling centers
- SD tools Ø 16 mm to Ø 100 mm are provided with coolant holes, which enable an inner coolant supply
- The best PVD coatings are available
- HSS and several carbide cutting inserts are available from the warehouse

The benefits and options for you

- Fast delivery from the Seengen warehouse
- Weldon type Ø 16 mm to Ø 40 mm
- Arbor type Ø 40 mm to Ø 160 mm
- With 3 cutting geometries a very large range of materials can be processed
- HSS cutting insert with TiN and TiAlN coatings are safe and efficient for the processing of many applications
- High removal rate (Q) with a relatively small machine load
- Good tool life and high productivity
- The same cutting inserts can also be used on the ALESA SPEED
- The latest developments show excellent cutting processes also with the most difficult Ni-, Ti- and Co- alloys
- Manufactured according to ISO certified processes
- For special tools, our construction with great experience is available

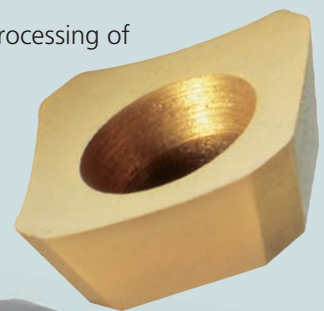

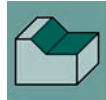

ALESA HEPTA milling cutter XO 06

XO 06 R 45° / Ø 40 - 160

1330

Face milling 45°

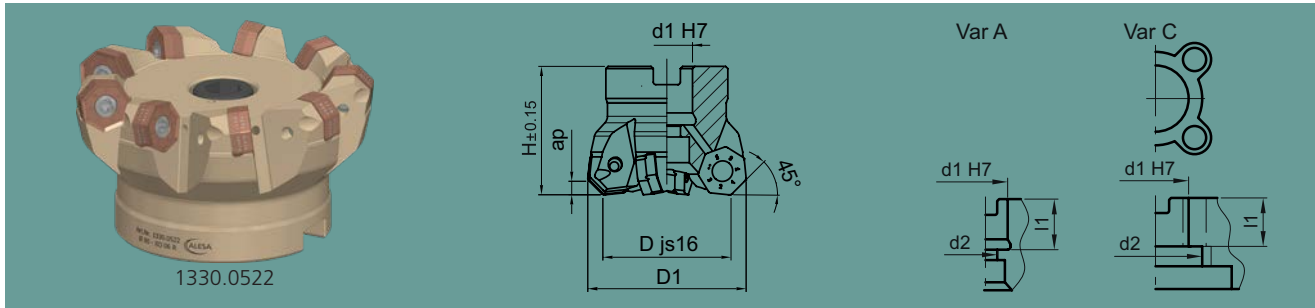

Part No	Type	D mm	D1 mm	H mm	d1 mm	d2 mm	l1 mm	ap mm				WSP
1330.0462	40-XO 06 R / Var A	40	49.5	40	16	8.5	18	4	✓	5	r	XOFU 06 05
1330.0482	50-XO 06 R / Var A	50	59.5	44	22	11	20	4	✓	6	r	XOFU 06 05
1330.0502	63-XO 06 R / Var A	63	72.5	44	22	11	20	4	✓	7	r	XOFU 06 05
1330.0522	80-XO 06 R / Var A	80	89.5	51	27	14	22	4	✓	9	r	XOFU 06 05
1330.0542	100-XO 06 R / Var A	100	109.5	55	32	18	25	4	✓	10	r	XOFU 06 05
1330.0562	125-XO 06 R / Var A	125	134.5	67	40	22	29	4	✓	10	r	XOFU 06 05
1330.0582	160-XO 06 R / Var C	160	169.5	67	40	54	29	4	✓	14	r	XOFU 06 05
1330.0584	160-XO 06 R / Var C	160	169.5	67	40	54	29	4		14	r	XOFU 06 05

Helical milling (B = Recommended pitch per helical rotation)

XO06	Ø D	B	min Ø	max Ø
	40	1.0	83	98
50	1.0	103	118	
63	1.0	129	144	
80	1.0	163	178	
100	1.0	203	218	
125	1.0	253	268	
160	1.0	323	338	

Plunging and ramping

XO06	Ø D	az	β
	40	0.55	0.9°
50	0.55	0.7°	
63	0.55	0.5°	
80	0.55	0.4°	
100	0.55	0.3°	
125	0.55	0.2°	
160	0.55	0.2°	

Part No	Torx screw				Screw-driver		Hex socket head screw		
	Qty	Article	Type	Torque	Article	Type	Article	Type	Torque
1330.0462	5	1490.0380	M4 x 11	3.85 Nm	1492.0600	T20	1490.0759	M8 x 20	30 Nm
1330.0482	6	1490.0380	M4 x 11	3.85 Nm	1492.0600	T20	1490.0770	M10 x 25	50 Nm
1330.0502	7	1490.0380	M4 x 11	3.85 Nm	1492.0600	T20	1490.0770	M10 x 25	50 Nm
1330.0522	9	1490.0380	M4 x 11	3.85 Nm	1492.0600	T20	1490.0780	M12 x 30	90 Nm
1330.0542	10	1490.0380	M4 x 11	3.85 Nm	1492.0600	T20	1490.0789	M16 x 30	160 Nm
1330.0562	10	1490.0380	M4 x 11	3.85 Nm	1492.0600	T20	1490.0800	M20 x 40	230 Nm
1330.0582	14	1490.0380	M4 x 11	3.85 Nm	1492.0600	T20	1490.0800	M20 x 40	230 Nm
1330.0584	14	1490.0380	M4 x 11	3.85 Nm	1492.0600	T20	1490.0800	M20 x 40	230 Nm

Info Excellent tool for face milling.

Info Better surface due to a ground face cutting edge.

Recommended application range: $a_e < 40\%$ or $a_e > 60\%$ of the tool diameter.

a_p (max) = 3 mm for multipass milling.

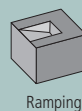
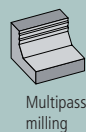
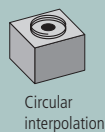
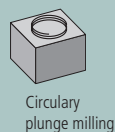
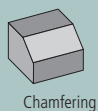



ALESA HEPTA milling cutter XO 06

XO 06 R 45° / Ø 40 - 160

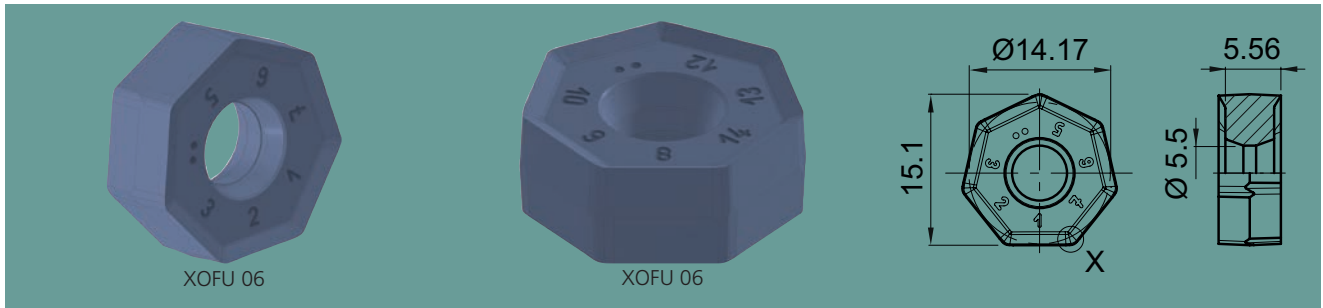

Face milling 45°

Cutting material	Coating	Part No	ISO Code	Detail X				Werkstoffklassen					
								1	2	3	4	5	6
Carbide CTS	AlCrN-VA	1279.0200	XOFU 06 05 08 FR-322	R 0.8	r	●	○	●	○	○	○	○	○
Carbide CTS-X	TiNox	1279.0267	XOFU 06 05 08 FR-732	R 0.8	r	●	○	○	○	○	○	○	○
Carbide CTM	TiNox	1279.0317	XOFU 06 05 08 FR-932	R 0.8	r	●	○	○	○	○	○	○	○

Fitting instructions for inserts see page 136

Zusatznummer Wendschneidplatten ISO-Code (Schneidengeometrie)
Additional number indexable inserts ISO-code (cutting geometry)
Numéro supplémentaire plaquettes amovibles code ISO (géométrie de coupe)

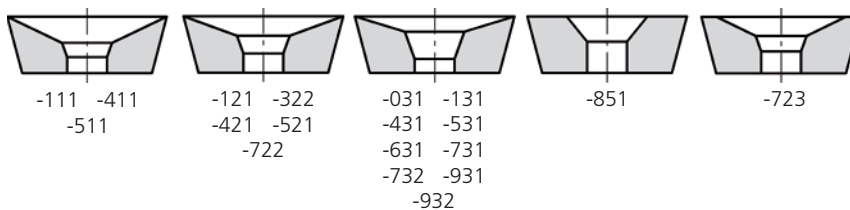

Overview of all indexable inserts see page 106 and following.

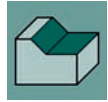

ALESA end mill SD 09

SD 09 R 45° / Ø 16 - 40

1349

Face milling 45°

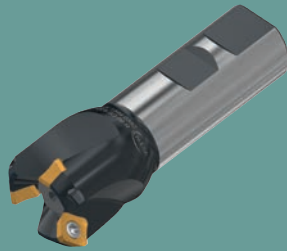

1349.0380

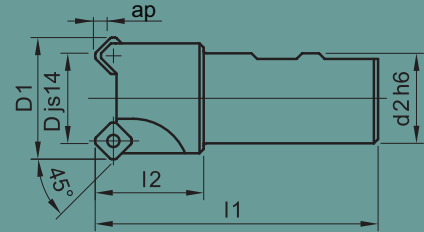

Part No	Type	D mm	D1 mm	l2 mm	d2 mm	l1 mm	ap mm				WSP
1349.0300	16-SD 09 R	16	26	22	16	75	4.7	✓	2	r	SD.T 09 T3
1349.0340	20-SD 09 R	20	30	28	20	82	4.7	✓	2	r	SD.T 09 T3
1349.0380	25-SD 09 R	25	35	35	25	96	4.7	✓	3	r	SD.T 09 T3
1349.0420	32-SD 09 R	32	42	35	32	100	4.7	✓	4	r	SD.T 09 T3

*while stocks last

Tool will be delivered with holder, all screws and screw-driver, but without indexable inserts.

Helical milling (B = Recommended pitch per helical rotation)

SD09	Ø D	B	min Ø	
			min Ø	max Ø
	16	0.2	40	51
	20	0.2	48	59
	25	0.2	58	69
	32	0.2	72	83

Plunging and ramping

SD09	Ø D	Plunging and ramping	
		az	β
	16	0.15	0.6°
	20	0.10	0.3°
	25	0.10	0.2°
	32	0.10	0.1°

Accessories / spare parts

Part No	Torx screw				Screw-driver	
	Qty	Article	Type	Torque	Article	Type
1349.0300	2	1490.0280	M3.5 x 7	2.55 Nm	1492.0500	T15
1349.0340	2	1490.0290	M3.5 x 8	2.55 Nm	1492.0500	T15
1349.0380	3	1490.0290	M3.5 x 8	2.55 Nm	1492.0500	T15
1349.0420	4	1490.0290	M3.5 x 8	2.55 Nm	1492.0500	T15



When operating circular motion full slot and dip milling ap is max = 3 mm.



Highly positive, extremely sharp cutting edge of HSS-E and carbide.



ALESA tools are distinguished by their very precise concentricity.



Face milling



Chamfering



Circular
plunge milling



Circular
interpolation



Ramping



Multipass
milling



ALESA end mill SD 09

SD 09 R 45° / Ø 16 - 40

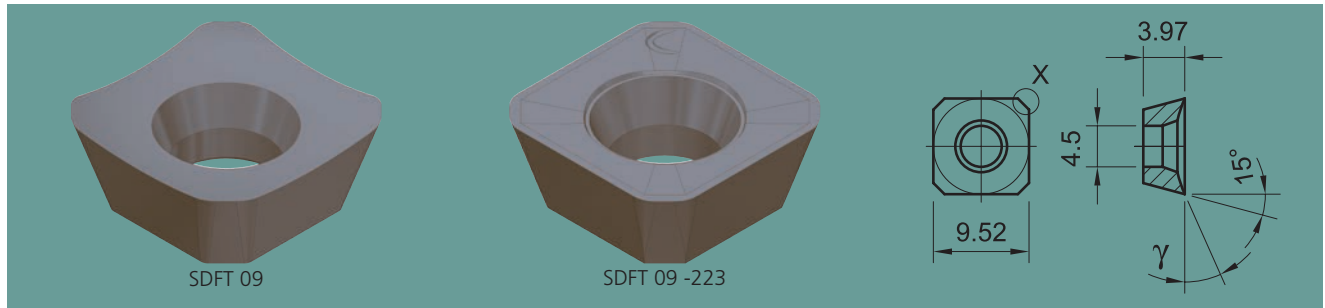

Face milling 45°

Cutting material	Coating	Part No	ISO Code	γ	Detail X				Werkstoffklassen					
									1	2	3	4	5	6
HSS-E	TiN	1091.0400	SDFT 09 T3 AE FN	17°	1.2x45° R1.2	r/l	●		○	○		●		●
	TiAlN	1166.0400	SDFT 09 T3 AE FN	17°	1.2x45° R1.2	r/l	●		○	●		●	○	●
Carbide MG20	TiN	1291.0400	SDFT 09 T3 AE FN-111	17°	1.2x45° R1.2	r/l	○	●	●	○	●	●		●
	TiAlN	1291.0405	SDFT 09 T3 AE FN-111	17°	1.2x45° R1.2	r/l	○	●	●	○	●	●		●
	AlCrN	1291.0415	SDFT 09 T3 AE FN-111	17°	1.2x45° R1.2	r/l	○	●	●	○	●	●		●
Carbide 12CR	TiAlN	1291.0420*	SDHT 09 T3 AE FN-222	11°	1.2x45° R1.2	r/l	○	●	●	○	●	○	●	
	AlCrN	1291.0430*	SDHT 09 T3 AE FN-222	11°	1.2x45° R1.2	r/l	○	●	●	○	●	○	●	
		1291.0630*	SDFT 09 T3 AE FN-223	5°	1.2x45° R1.2	r/l	○	●	●	○	●	○	●	
	AlCrN-VA	1291.0635*	SDFT 09 T3 AE FN-223	5°	1.2x45° R1.2	r/l	○	●	●	○	●	○	●	
	DLC-H	1291.0640*	SDFT 09 T3 AE FN-223	5°	1.2x45° R1.2	r/l	●	○	○	○	○	○	●	
Carbide CTS-X	TiNox	1291.0320	SDHT 09 T3 AE FN-722	11°	1.2x45° R1.2	r/l	●	○	○	○	○	○		
		1291.0520	SDFT 09 T3 AE FN-723	5°	1.2x45° R1.2	r/l	●	○	○	○	○	○		
Ceramic KG14	AlCrN-K	1292.0200*	SDFT 09 T3 AE FN-851	0°	1.2x45° R1.2	r/l		●						

Fitting instructions for inserts see page 136

*while stocks last

Zusatznummer Wendeschneidplatten ISO-Code (Schneidengeometrie)
 Additional number indexable inserts ISO-code (cutting geometry)
 Numéro supplémentaire plaquettes amovibles code ISO (géométrie de coupe)

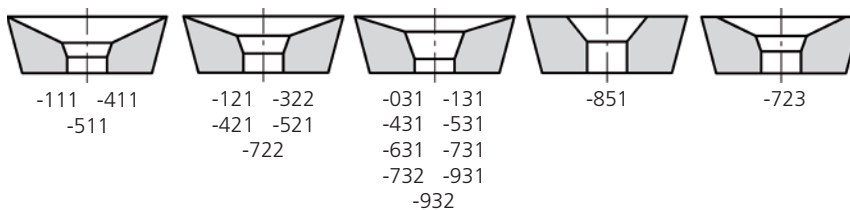

Overview of all indexable inserts see page 106 and following.

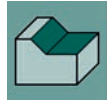

ALESA milling cutter SD 09

SD 09 R 45° / Ø 40 - 100

1316

Face milling 45°



1316.0520

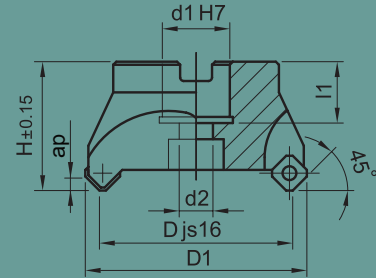

Part No	Type	D mm	D1 mm	H mm	d1 mm	d2 mm	l1 mm	ap mm				WSP
1316.0460	40-SD 09 R	40	50	40	16	8.5	18	4.7	✓	5	r	SD.T 09 T3
1316.0480	50-SD 09 R	50	60	42	22	11	20	4.7	✓	6	r	SD.T 09 T3
1316.0500	63-SD 09 R	63	73	42	22	11	20	4.7	✓	7	r	SD.T 09 T3
1316.0520	80-SD 09 R	80	90	50	27	14	22	4.7	✓	9	r	SD.T 09 T3
1316.0540	100-SD 09 R	100	110	54	32	18	25	4.7	✓	11	r	SD.T 09 T3

*while stocks last

Helical milling (B = Recommended pitch per helical rotation)

SD09	Ø D	B	min Ø		max Ø	
			min	max	min	max
	40	1.0	88	99		
	50	1.0	108	119		
	63	1.0	134	145		
	80	1.0	168	179		
	100	1.0	208	219		

Plunging and ramping

SD09	Ø D	az	β	
			min	max
	40	4.0	6.9°	
	50	4.0	5.3°	
	63	4.0	4.0°	
	80	4.0	3.1°	
	100	4.0	2.4°	

Part No	Torx screw				Screw-driver		Hex socket head screw		
	Qty	Article	Type	Torque	Article	Type	Article	Type	Torque
1316.0460	5	1490.0290	M3.5 x 8	2.55 Nm	1492.0500	T15	1490.0759	M8 x 20	30 Nm
1316.0480	6	1490.0290	M3.5 x 8	2.55 Nm	1492.0500	T15	1490.0770	M10 x 25	50 Nm
1316.0500	7	1490.0290	M3.5 x 8	2.55 Nm	1492.0500	T15	1490.0770	M10 x 25	50 Nm
1316.0520	9	1490.0290	M3.5 x 8	2.55 Nm	1492.0500	T15	1490.0780	M12 x 30	90 Nm
1316.0540	11	1490.0290	M3.5 x 8	2.55 Nm	1492.0500	T15	1490.0789	M16 x 30	160 Nm

Info

Excellent tool for face milling.



Highly positive, extremely sharp cutting edge of HSS-E and carbide.



ALESA tools are distinguished by their very precise concentricity.



When operating circular motion full slot and dip milling ap is max = 3 mm.



Face milling



Chamfering



Circularly plunge milling



Circular interpolation



Ramping



Multipass milling



ALESA milling cutter SD 09

SD 09 R 45° / Ø 40 - 100

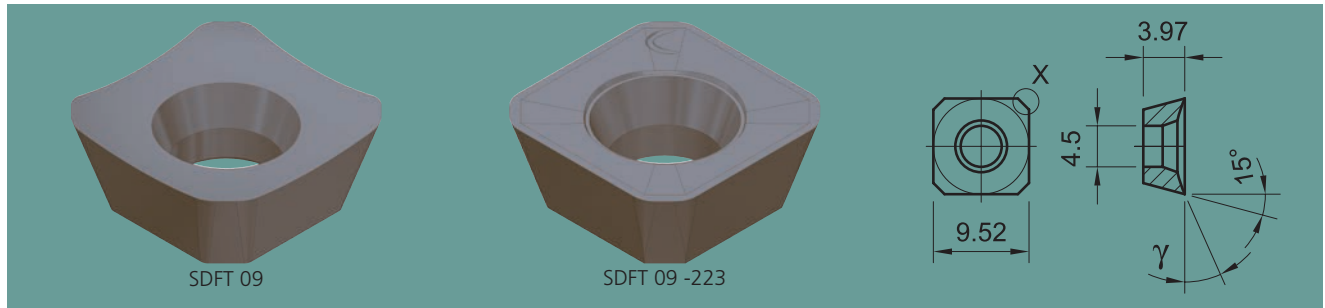

Face milling 45°

Cutting material	Coating	Part No	ISO Code	γ	Detail X				Werkstoffklassen					
									1	2	3	4	5	6
HSS-E	TiN	1091.0400	SDFT 09 T3 AE FN	17°	1.2x45° R1.2	r/l	●		○	○		●		●
	TiAlN	1166.0400	SDFT 09 T3 AE FN	17°	1.2x45° R1.2	r/l	●		○	●		●	○	●
Carbide MG20	TiN	1291.0400	SDFT 09 T3 AE FN-111	17°	1.2x45° R1.2	r/l	○	●	●	○	●	●		●
	TiAlN	1291.0405	SDFT 09 T3 AE FN-111	17°	1.2x45° R1.2	r/l	○	●	●	○	●	●		●
	AlCrN	1291.0415	SDFT 09 T3 AE FN-111	17°	1.2x45° R1.2	r/l	○	●	●	○	●	●		●
Carbide 12CR	TiAlN	1291.0420*	SDHT 09 T3 AE FN-222	11°	1.2x45° R1.2	r/l	○	●	●	○	●	○	●	
	AlCrN	1291.0430*	SDHT 09 T3 AE FN-222	11°	1.2x45° R1.2	r/l	○	●	●	○	●	○	●	
		1291.0630*	SDFT 09 T3 AE FN-223	5°	1.2x45° R1.2	r/l	○	●	●	○	●	○	●	
	AlCrN-VA	1291.0635*	SDFT 09 T3 AE FN-223	5°	1.2x45° R1.2	r/l	○	●	●	○	●	○	●	
	DLC-H	1291.0640*	SDFT 09 T3 AE FN-223	5°	1.2x45° R1.2	r/l	●	○	○	○	●	○	●	
Carbide CTS-X	TiNox	1291.0320	SDHT 09 T3 AE FN-722	11°	1.2x45° R1.2	r/l	●	○	○	○	○	○		
		1291.0520	SDFT 09 T3 AE FN-723	5°	1.2x45° R1.2	r/l	●	○	○	○	○	○		
Ceramic KG14	AlCrN-K	1292.0200*	SDFT 09 T3 AE FN-851	0°	1.2x45° R1.2	r/l		●						

Fitting instructions for inserts see page 136

*while stocks last

Zusatznummer Wendeschneidplatten ISO-Code (Schneidengeometrie)
 Additional number indexable inserts ISO-code (cutting geometry)
 Numéro supplémentaire plaquettes amovibles code ISO (géométrie de coupe)

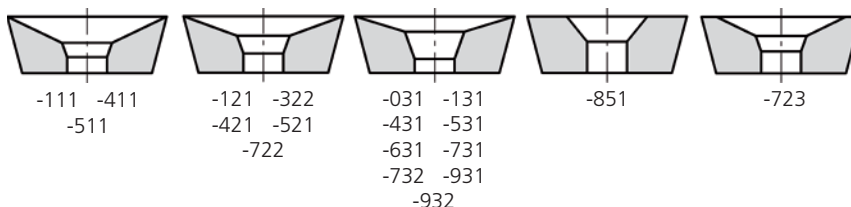

Overview of all indexable inserts see page 106 and following.



ALESA milling cutter SD 12

SD 12 R 45° / Ø 50 - 160

1319

Face milling 45°



1319.0520

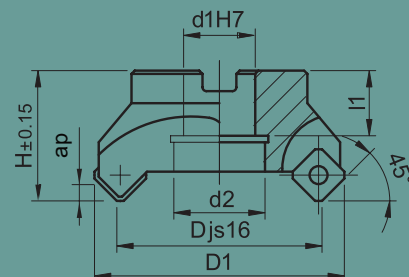

Part No	Type	D mm	D1 mm	H mm	d1 mm	d2 mm	l1 mm	ap mm				WSP
1319.0480	50-SD 12 R Z4	50	64	40	22	30	20	6.5		4	r	SD.T 12 04
1319.0482	50-SD 12 R Z5	50	64	40	22	30	20	6.5		5	r	SD.T 12 04
1319.0500	63-SD 12 R Z5	63	77	40	22	30	20	6.5		5	r	SD.T 12 04
1319.0502	63-SD 12 R Z7	63	77	40	22	30	20	6.5		7	r	SD.T 12 04
1319.0520	80-SD 12 R Z6	80	94	50	27	38	22	6.5		6	r	SD.T 12 04
1319.0522	80-SD 12 R Z8	80	94	50	27	38	22	6.5		8	r	SD.T 12 04
1319.0540	100-SD 12 R Z7	100	114	50	32	45	25	6.5		7	r	SD.T 12 04
1319.0542	100-SD 12 R Z10	100	114	50	32	45	25	6.5		10	r	SD.T 12 04
1319.0560	125-SD 12 R Z8	125	139	63	40	56	28	6.5		8	r	SD.T 12 04
1319.0562	125-SD 12 R Z11	125	139	63	40	56	28	6.5		11	r	SD.T 12 04
1319.0580	160-SD 12 R Z10	160	174	63	40	56	28	6.5		10	r	SD.T 12 04
1319.0582	160-SD 12 R Z14	160	174	63	40	56	28	6.5		14	r	SD.T 12 04

*while stocks last

Accessories / spare parts

Part No	Torx screw				Screw-driver	
	Qty	Article	Type	Torque	Article	Type
1319.0480	4	1490.0380	M4 x 11	3.85 Nm	1492.0600	T20
1319.0482	5	1490.0380	M4 x 11	3.85 Nm	1492.0600	T20
1319.0500	5	1490.0380	M4 x 11	3.85 Nm	1492.0600	T20
1319.0502	7	1490.0380	M4 x 11	3.85 Nm	1492.0600	T20
1319.0520	6	1490.0380	M4 x 11	3.85 Nm	1492.0600	T20
1319.0522	8	1490.0380	M4 x 11	3.85 Nm	1492.0600	T20
1319.0540	7	1490.0380	M4 x 11	3.85 Nm	1492.0600	T20
1319.0542	10	1490.0380	M4 x 11	3.85 Nm	1492.0600	T20
1319.0560	8	1490.0380	M4 x 11	3.85 Nm	1492.0600	T20
1319.0562	11	1490.0380	M4 x 11	3.85 Nm	1492.0600	T20
1319.0580	10	1490.0380	M4 x 11	3.85 Nm	1492.0600	T20
1319.0582	14	1490.0380	M4 x 11	3.85 Nm	1492.0600	T20



Excellent tool for face milling.



When operating circular motion full slot and dip milling ap is max = 4 mm.



Face milling



Chamfering



Circular
plunge milling



Circular
interpolation



Ramping



Multipass
milling



ALESA milling cutter SD 12

SD 12 R 45° / Ø 50 - 160

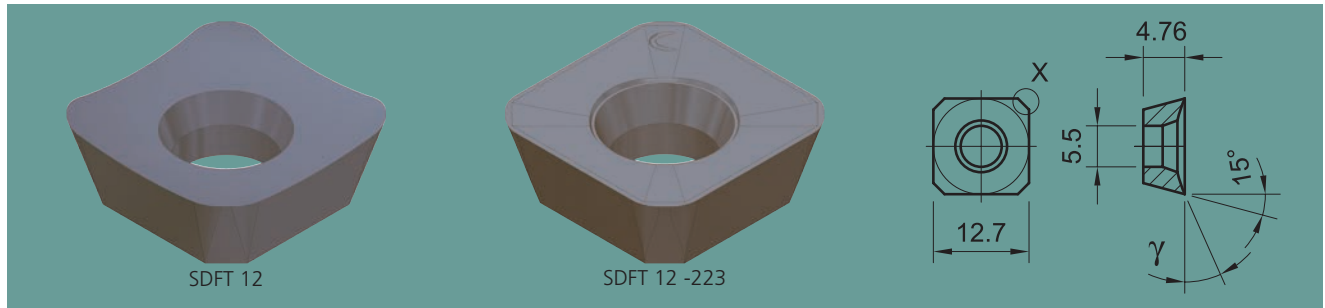

Face milling 45°

Cutting material	Coating	Part No	ISO Code	γ	Detail X				Werkstoffklassen					
									1	2	3	4	5	6
HSS-E	TiN	1091.0450	SDFT 12 04 AE FN	17°	1.5x45° R2	r/l	●		○	○		●		●
	TiAlN	1166.0450	SDFT 12 04 AE FN	17°	1.5x45° R2	r/l	●		○	●		●	○	●
Carbide MG20	TiN	1291.0450	SDFT 12 04 AE FN-111	17°	1.5x45° R2	r/l	○	●	●	○	●	●		●
	TiAlN	1291.0455	SDFT 12 04 AE FN-111	17°	1.5x45° R2	r/l	○	●	●	○	●	●		●
	AlCrN	1291.0465	SDFT 12 04 AE FN-111	17°	1.5x45° R2	r/l	○	●	●	○	●	●		●
Carbide 12CR	TiAlN	1291.0470*	SDHT 12 04 AE FN-222	11°	1.5x45° R2	r/l	○	●	●	○	●	○	●	
	AlCrN	1291.0480*	SDHT 12 04 AE FN-222	11°	1.5x45° R2	r/l	○	●	●	○	●	○	●	
		1291.0680*	SDFT 12 04 AE FN-223	5°	1.5x45° R2	r/l	○	●	●	○	●	○	●	
	AlCrN-VA	1291.0685*	SDFT 12 04 AE FN-223	5°	1.5x45° R2	r/l	○	●	●	○	●	○	●	
	DLC-H	1291.0690*	SDFT 12 04 AE FN-223	5°	1.5x45° R2	r/l	●	○	○	○	○	○	○	
Carbide CTS-X	TiNox	1291.0370	SDFT 12 04 AE FN-722	11°	1.5x45° R2	r/l	●	○	○	○	○	○	○	
		1291.0570	SDFT 12 04 AE FN-723	5°	1.5x45° R2	r/l	●	○	○	○	○	○	○	
Ceramic KG14	AlCrN-K	1292.0225*	SDFT 12 04 AE FN-851	0°	1.5x45° R2	r/l		●						

Fitting instructions for inserts see page 136

*while stocks last

Zirkular-Fräsen (B = empfohlene Zustellung pro Umgang)
Helical milling (B = Recommended pitch per helical rotation)
Fraisage hélicoïdal (B = Avance recommandée par passage)

SD12	Ø D	B	min Ø	max Ø
	50	1.5	111	126
	63	1.5	137	152
	80	1.5	171	186
	100	1.5	211	226
	125	1.5	261	276
	160	1.5	331	346

Axial- und Schrägeintauchen
Plunging and ramping
Plongée axiale et oblique

SD12	Ø D	az	β
	50	6.0	8.4°
	63	6.0	6.4°
	80	6.0	4.8°
	100	6.0	3.8°
	125	6.0	2.9°
	160	6.0	2.2°

Overview of all indexable inserts see page 106 and following.

High feed milling

ALESA SPEED

The characteristics

- High Performance Cutting for modern 5-axis machines
- SWISS Precision Tool. The milling head and cutting inserts are manufactured in Switzerland
- Kappa angle 15°, high rough performance
- The peeling cutting process is very spindle and machine-friendly
- The sharp edges and the arrangement of the cutting inserts generate spindle-friendly cutting forces, which work mainly axially
- All tools are provided with cooling holes
With center cooling in addition
- The best PVD coatings are available
- HSS and carbide cutting inserts with various cutting geometries available from the warehouse



The benefits and options for you

- Fast delivery from the Seengen warehouse
- The proved and tested SD 09 or SD 12 cutting insert can be used.
4 cutting edges per cutting insert are very effective
- Ø 12 mm to Ø 25 mm are available as Weldon and a screw-in toolholder
- Arbor milling cutters in the range Ø 32 mm to Ø 83 mm
- For the large range of materials, the economical cutting inserts with 3 available cutting geometries can be chosen
- Carbide grades are available for dry and wet processing
Unique to ALESA Ltd., the HSS cutting inserts are also available
- HSS is reliable and efficient with many applications
- Process-safe and high removal rate (Q) with a relatively small machine load
- Good tool life and high productivity
- The high-feed tools are used in applications with large 6xD - 10xD tool extensions
- Suitable for circular plunging into solid material for holes from Ø 27 mm (SD 09) to Ø 206 mm (SD 12)
- Excellent for pockets and free-form shapes
- Excellent machining properties also with the most difficult Duplex, Ni-, and Ti- alloys
- Manufactured according to ISO certified processes
- For special tools, our construction with great experience is available

High feed milling

ALESA TWIST with inserts type 481/681

The characteristics

- Additional benefits of the ALESA TWIST tool holder family
- SWISS Precision Tool. The milling head and cutting inserts are manufactured in Switzerland
- In addition to the profile cutting inserts, high feed cutting inserts type 481/681 are also available
- New milling strategy: small cutting depth (ap) and high-tooth feed
- The sharpened cutting edges require less power than pure sintered high-feed cutting inserts
- The small cutting forces cause less vibrations and are spindle-friendly
- The sharp-ground cutting inserts are optimized for modern 5-axis milling centers
- All ALESA TWIST tools are provided with cooling holes. The cooling medium is exactly there where it is needed
- The best PVD coatings are available



The benefits and options for you

- Fast delivery from the Seengen warehouse
- Ø 16 mm to Ø 25 mm as Weldon
- Ø 16 mm to Ø 32 mm screw-in tools
- Arbor milling cutter Ø 32 mm to Ø 50 mm
- Carbide qualities are present for dry and wet machining processes
- High removal rate (Q) with a relatively small machine load and very good process safety
- The high-feed tools are used in applications with large 6xD - 10xD tool extensions
- Suitable for circular plunging into solid material for holes from Ø 19 mm
- Excellent for pockets and free-form shapes
- Good tool life and high productivity
- Excellent metal cutting properties with the most difficult Ni-, Ti- and Co- alloys
- Manufactured according to ISO certified processes
- For special tools, our construction with great experience is available





ALESA SPEED end mill and threaded type cutter

SD 09 R 15° / Ø 12 - 25

1352 / 1353

High feed milling



Part No	Type	D mm	D1 mm	l2 mm	G	d2 mm	l1 mm	ap mm				WSP
1352.0240	12-SD 09 SPEED	12	27	26		16	75	1.75	✓	2	r	SD.T 09 T3
1353.0240	12-SD 09 SPEED	12	27	32	M10	10.5	50	1.75	✓	2	r	SD.T 09 T3
1352.0300	16-SD 09 SPEED Z2	16	31	31		20	82	1.75	✓	2	r	SD.T 09 T3
1352.0305	16-SD 09 SPEED Z3	16	31	33		25	90	1.75	✓	3	r	SD.T 09 T3
1353.0300	16-SD 09 SPEED Z2	16	31	32	M12	12.5	52	1.75	✓	2	r	SD.T 09 T3
1353.0305	16-SD 09 SPEED Z3	16	31	32	M12	12.5	52	1.75	✓	3	r	SD.T 09 T3
1352.0380	25-SD 09 SPEED	25	40	39		25	96	1.75	✓	3	r	SD.T 09 T3
1353.0380	25-SD 09 SPEED	25	40	40	M16	17	62	1.75	✓	3	r	SD.T 09 T3

*while stocks last

Tool will be delivered with holder, all screws and screw-driver, but without indexable inserts.

Helical milling (B = Recommended pitch per helical rotation)

SPEED SD09	Ø D	B	min Ø	max Ø
	12	1.0	39	53
16	1.0	47	61	
25	1.0	65	79	

Plunging and ramping

SPEED SD09	Ø D	az	β
	12	0.35	1.8°
16	1.00	4.0°	
25	1.00	2.4°	

Accessories / spare parts

Part No	Torx screw				Screw-driver	
	Qty	Article	Type	Torque	Article	Type
1352.0240	2	1490.0290	M3.5 x 8	2.55 Nm	1492.0500	T15
1353.0240	2	1490.0290	M3.5 x 8	2.55 Nm	1492.0500	T15
1352.0300	2	1490.0290	M3.5 x 8	2.55 Nm	1492.0500	T15
1352.0305	3	1490.0290	M3.5 x 8	2.55 Nm	1492.0500	T15
1353.0300	2	1490.0290	M3.5 x 8	2.55 Nm	1492.0500	T15
1353.0305	3	1490.0290	M3.5 x 8	2.55 Nm	1492.0500	T15
1352.0380	3	1490.0290	M3.5 x 8	2.55 Nm	1492.0500	T15
1353.0380	3	1490.0290	M3.5 x 8	2.55 Nm	1492.0500	T15

Info The flat Kappa angle of around 15° allows a very high feed per tooth.

Info This tool mainly generates forces in axial direction, which allows big protrudings and preserves the spindle.

Info Due to the wide range of SD indexable inserts, the entire material range can also be machined with the SPEED milling cutter.



Face milling



Circular plunge milling



Circular interpolation



Ramping



Multipass milling



ALESA SPEED end mill and threaded type cutter SD 09 R 15° / Ø 12 - 25

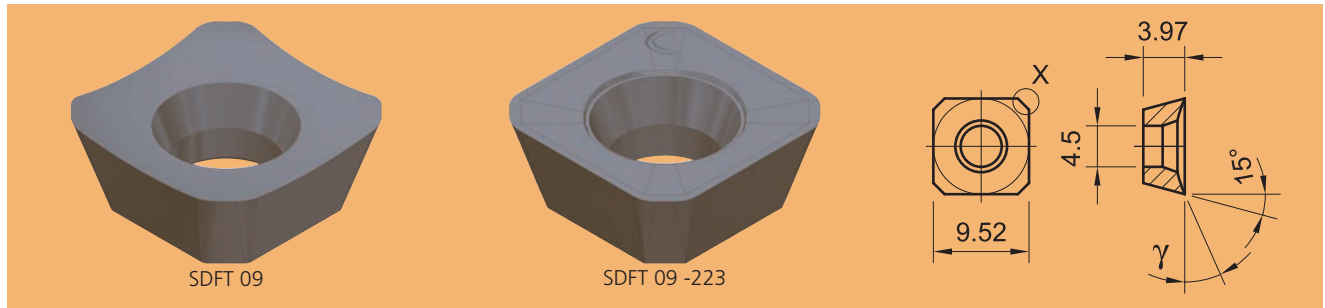

High feed milling

Cutting material	Coating	Part No	ISO Code	γ	Detail X				Werkstoffklassen					
									1	2	3	4	5	6
HSS-E	TiN	1091.0400	SDFT 09 T3 AE FN	17°	1.2x45° R1.2	r/l	●		○	○		●		●
	TiAlN	1166.0400	SDFT 09 T3 AE FN	17°	1.2x45° R1.2	r/l	●		○	●		●	○	●
Carbide MG20	TiN	1291.0400	SDFT 09 T3 AE FN-111	17°	1.2x45° R1.2	r/l	○	●	●	○	●	●		●
	TiAlN	1291.0405	SDFT 09 T3 AE FN-111	17°	1.2x45° R1.2	r/l	○	●	●	○	●	●		●
	AlCrN	1291.0415	SDFT 09 T3 AE FN-111	17°	1.2x45° R1.2	r/l	○	●	●	○	●	●		●
Carbide 12CR	TiAlN	1291.0420*	SDHT 09 T3 AE FN-222	11°	1.2x45° R1.2	r/l	○	●	●	○	●	○	●	
	AlCrN	1291.0430*	SDHT 09 T3 AE FN-222	11°	1.2x45° R1.2	r/l	○	●	●	○	●	○	●	
		1291.0630*	SDFT 09 T3 AE FN-223	5°	1.2x45° R1.2	r/l	○	●	●	○	●	○	●	
	AlCrN-VA	1291.0635*	SDFT 09 T3 AE FN-223	5°	1.2x45° R1.2	r/l	○	●	●	○	●	○	●	
	DLC-H	1291.0720*	SDFT 09 T3 AE FR-223-S	5°	1.2x45° R1.2	r	○	●	●	○	●	○	●	
Carbide CTS-X	TiNox	1291.0640*	SDFT 09 T3 AE FN-223	5°	1.2x45° R1.2	r/l	●	○	○	○	○	○	○	
		1291.0320	SDHT 09 T3 AE FN-722	11°	1.2x45° R1.2	r/l	●	○	○	○	○	○	○	
Ceramic KG14	AlCrN-K	1291.0520	SDFT 09 T3 AE FN-723	5°	1.2x45° R1.2	r/l	●	○	○	○	○	○	○	
		1292.0200*	SDFT 09 T3 AE FN-851	0°	1.2x45° R1.2	r/l			●					

Fitting instructions for inserts see page 136.

The additional specification -S of the inserts ISO-code means "finishing insert".

*while stocks last

Zusatznummer Wendeschneidplatten ISO-Code (Schneidengeometrie)
Additional number indexable inserts ISO-code (cutting geometry)
Numéro supplémentaire plaquettes amovibles code ISO (géométrie de coupe)

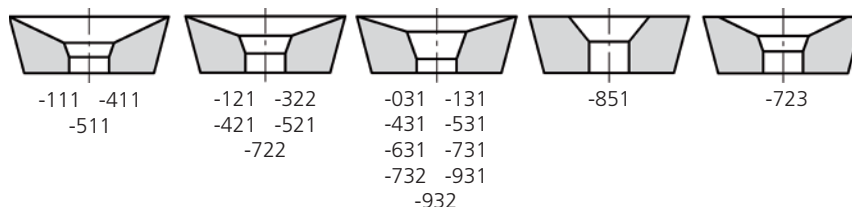

Overview of all indexable inserts see page 106 and following.

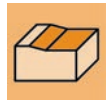

ALESA SPEED milling cutter SD 09

SD 09 R 15° / Ø 32 - 50

1318

High feed milling



1318.0460

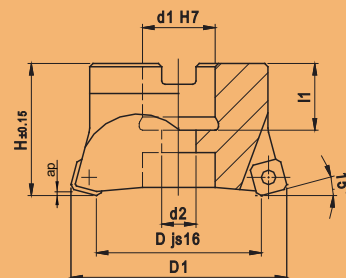

Part No	Type	D mm	D1 mm	H mm	d1 mm	d2 mm	l1 mm	ap mm				WSP
1318.0420	32-SD 09 SPEED	32	47	32	16	8.5	18	1.75	✓	4	r	SD.T 09 T3
1318.0460	40-SD 09 SPEED	40	55	40	22	11	20	1.75	✓	5	r	SD.T 09 T3
1318.0480	50-SD 09 SPEED	50	65	40	22	11	20	1.75	✓	6	r	SD.T 09 T3

*while stocks last

Helical milling (B = Recommended pitch per helical rotation)

SPEED SD09	Ø D	B	min Ø	max Ø
	32	1.0	79	93
40	1.0	95	109	
50	1.0	115	129	

Plunging and ramping

SPEED SD09	Ø D	az	β
32	1.0	1.8°	
40	1.0	1.4°	
50	1.0	1.1°	

Part No	Torx screw				Screw-driver		Hex socket head screw		
	Qty	Article	Type	Torque	Article	Type	Article	Type	Torque
1318.0420	4	1490.0290	M3.5 x 8	2.55 Nm	1492.0500	T15	1490.0759	M8 x 20	30 Nm
1318.0460	5	1490.0290	M3.5 x 8	2.55 Nm	1492.0500	T15	1490.0770	M10 x 25	50 Nm
1318.0480	6	1490.0290	M3.5 x 8	2.55 Nm	1492.0500	T15	1490.0770	M10 x 25	50 Nm

Info The flat Kappa angle of around 15° allows a very high feed per tooth.

Info This tool mainly generates forces in axial direction, which allows big protrudings and preserves the spindle.

Info Due to the wide range of SD indexable inserts, the entire material range can also be machined with the SPEED milling cutter.



Face milling



Circular plunge milling



Circular interpolation



Ramping



Multipass milling



ALESA SPEED milling cutter SD 09

SD 09 R 15° / Ø 32 - 50

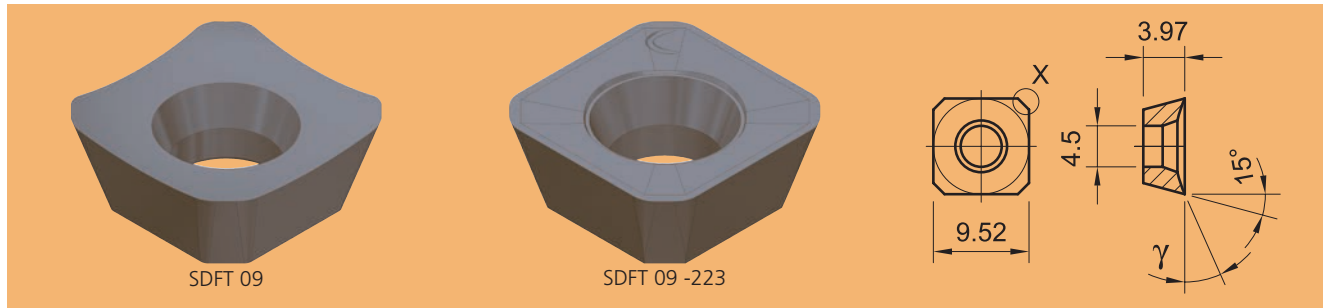

High feed milling

Cutting material	Coating	Part No	ISO Code	γ	Detail X				Werkstoffklassen					
									1	2	3	4	5	6
HSS-E	TiN	1091.0400	SDFT 09 T3 AE FN	17°	1.2x45° R1.2	r/l	●		○	○		●		●
	TiAlN	1166.0400	SDFT 09 T3 AE FN	17°	1.2x45° R1.2	r/l	●		○	●		●	○	●
Carbide MG20	TiN	1291.0400	SDFT 09 T3 AE FN-111	17°	1.2x45° R1.2	r/l	○	●	●	○	●	●		●
	TiAlN	1291.0405	SDFT 09 T3 AE FN-111	17°	1.2x45° R1.2	r/l	○	●	●	○	●	●		●
	AlCrN	1291.0415	SDFT 09 T3 AE FN-111	17°	1.2x45° R1.2	r/l	○	●	●	○	●	●		●
Carbide 12CR	TiAlN	1291.0420*	SDHT 09 T3 AE FN-222	11°	1.2x45° R1.2	r/l	○	●	●	○	●	○	●	
	AlCrN	1291.0430*	SDHT 09 T3 AE FN-222	11°	1.2x45° R1.2	r/l	○	●	●	○	●	○	●	
		1291.0630*	SDFT 09 T3 AE FN-223	5°	1.2x45° R1.2	r/l	○	●	●	○	●	○	●	
	AlCrN-VA	1291.0635*	SDFT 09 T3 AE FN-223	5°	1.2x45° R1.2	r/l	○	●	●	○	●	○	●	
		1291.0720*	SDFT 09 T3 AE FN-223-S	5°	1.2x45° R1.2	r	○	●	●	○	●	○	●	
		1291.0640*	SDFT 09 T3 AE FN-223	5°	1.2x45° R1.2	r/l	●	○	○	○	○	○	○	
Carbide CTS-X	TiNox	1291.0320	SDHT 09 T3 AE FN-722	11°	1.2x45° R1.2	r/l	●	○	○	○	○	○	○	
		1291.0520	SDFT 09 T3 AE FN-723	5°	1.2x45° R1.2	r/l	●	○	○	○	○	○	○	
Ceramic KG14	AlCrN-K	1292.0200*	SDFT 09 T3 AE FN-851	0°	1.2x45° R1.2	r/l		●						

Fitting instructions for inserts see page 136.

The additional specification -S of the inserts ISO-code means "finishing insert".

*while stocks last

Zusatznummer Wendeschneidplatten ISO-Code (Schneidengeometrie)
Additional number indexable inserts ISO-code (cutting geometry)
Numéro supplémentaire plaquettes amovibles code ISO (géométrie de coupe)

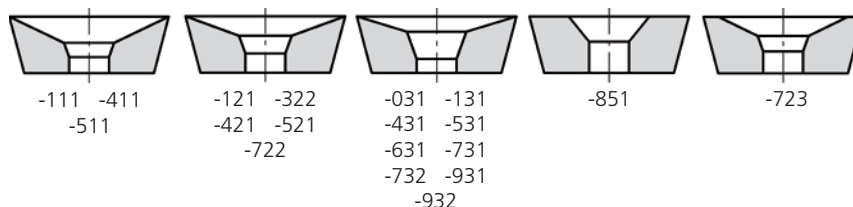

Overview of all indexable inserts see page 106 and following.

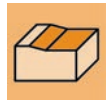

ALESA SPEED milling cutter SD 12

SD 12 R 15° / Ø 50 - 83

1322

High feed milling



1322.0480

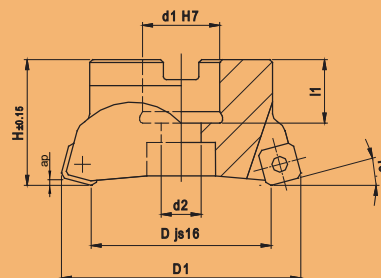

Part No	Type	D mm	D1 mm	H mm	d1 mm	d2 mm	l1 mm	ap mm				WSP
1322.0480	D50-SD 12 SPEED	50	70	40	22	11	20	2.5	✓	5	r	SD.T 12 04
1322.0500	D63-SD 12 SPEED	63	83	45	27	14	22	2.5	✓	6	r	SD.T 12 04
1322.0530	D83-SD 12 SPEED	83	103	50	32	18	25	2.5	✓	7	r	SD.T 12 04

*while stocks last

Helical milling (B = Recommended pitch per helical rotation)

SPEED SD12	Ø D	B	min Ø	
			min Ø	max Ø
	50	1.5	120	139
	63	1.5	146	165
	83	1.5	186	205

Plunging and ramping

SPEED SD12	Ø D	Plunging and ramping	
		az	β
	50	1.3	1.5°
	63	1.3	1.2°
	80	1.3	0.9°

Part No	Torx screw				Screw-driver		Hex socket head screw		
	Qty	Article	Type	Torque	Article	Type	Article	Type	Torque
1322.0480	5	1490.0380	M4 x 11	3.85 Nm	1492.0600	T20	1490.0770	M10 x 25	50 Nm
1322.0500	6	1490.0380	M4 x 11	3.85 Nm	1492.0600	T20	1490.0770	M12 x 30	90 Nm
1322.0530	7	1490.0380	M4 x 11	3.85 Nm	1492.0600	T20	1490.0770	M16 x 30	160 Nm

Info The flat Kappa angle of around 15° allows a very high feed per tooth.

Info This tool mainly generates forces in axial direction, which allows big protrudings and preserves the spindle.

Info Due to the wide range of SD indexable inserts, the entire material range can also be machined with the SPEED milling cutter.



Face milling



Circular plunge milling



Circular interpolation



Ramping



Multipass milling



ALESA SPEED milling cutter SD 12

SD 12 R 15° / Ø 50 - 83

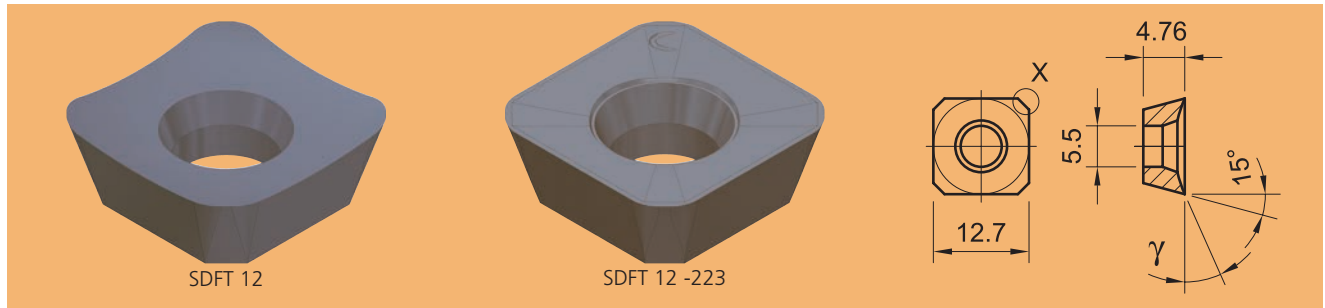

High feed milling

Cutting material	Coating	Part No	ISO Code	γ	Detail X				Werkstoffklassen					
									1	2	3	4	5	6
HSS-E	TiN	1091.0450	SDFT 12 04 AE FN	17°	1.5x45° R2	r/l	●		○	○		●		●
	TiAlN	1166.0450	SDFT 12 04 AE FN	17°	1.5x45° R2	r/l	●		○	●		●	○	●
Carbide MG20	TiN	1291.0450	SDFT 12 04 AE FN-111	17°	1.5x45° R2	r/l	○	●	●	○	●	●		●
	TiAlN	1291.0455	SDFT 12 04 AE FN-111	17°	1.5x45° R2	r/l	○	●	●	○	●	●		●
	AlCrN	1291.0465	SDFT 12 04 AE FN-111	17°	1.5x45° R2	r/l	○	●	●	○	●	●		●
Carbide 12CR	TiAlN	1291.0470*	SDHT 12 04 AE FN-222	11°	1.5x45° R2	r/l	○	●	●	○	●	○	●	
	AlCrN	1291.0480*	SDHT 12 04 AE FN-222	11°	1.5x45° R2	r/l	○	●	●	○	●	○	●	
		1291.0680*	SDFT 12 04 AE FN-223	5°	1.5x45° R2	r/l	○	●	●	○	●	○	●	
	AlCrN-VA	1291.0685*	SDFT 12 04 AE FN-223	5°	1.5x45° R2	r/l	○	●	●	○	●	○	●	
	DLC-H	1291.0770*	SDFT 12 04 AE FR-223-S	5°	1.5x45° R2	r	○	●	●	○	●	○	●	
Carbide CTS-X	TiNox	1291.0690*	SDFT 12 04 AE FN-223	5°	1.5x45° R2	r/l	●	○	○	○	○	○	○	
		1291.0370	SDFT 12 04 AE FN-722	11°	1.5x45° R2	r/l	●	○	○	○	○	○	○	
Ceramic KG14	AlCrN-K	1291.0570	SDFT 12 04 AE FN-723	5°	1.5x45° R2	r/l	●	○	○	○	○	○	○	
		1292.0225*	SDFT 12 04 AE FN-851	0°	1.5x45° R2	r/l			●					

Fitting instructions for inserts see page 136.
The additional specification -S of the inserts ISO-code means "finishing insert".
*while stocks last

Zusatznummer Wendeschneidplatten ISO-Code (Schneidengeometrie)
Additional number indexable inserts ISO-code (cutting geometry)
Numéro supplémentaire plaquettes amovibles code ISO (géométrie de coupe)

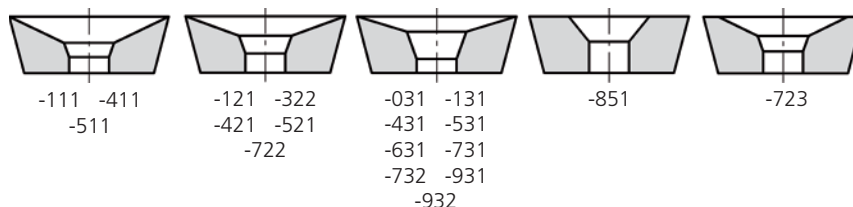

Overview of all indexable inserts see page 106 and following.

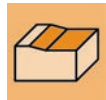

ALESA TWIST high feed cutter

AO 10 / Ø 16 - 32

1347 / 1348

High feed milling



Part No	Type	D mm	l2 mm	d2 mm	G	l1 mm				WSP
1347.0300	16-AO 10 R	16	25	16		75	✓	2	r	AOFT 10 03
1348.0300	16-AO 10 R	16	25	8.5	M8	41	✓	2	r	AOFT 10 03
1347.0338	20-AO 10 R Z2	20	30	20		82	✓	2	r	AOFT 10 03
1347.0340	20-AO 10 R Z3	20	30	20		82	✓	3	r	AOFT 10 03
1348.0340	20-AO 10 R	20	30	10.5	M10	48	✓	3	r	AOFT 10 03
1347.0382	25-AO 10 R	25	38	25		96	✓	4	r	AOFT 10 03
1348.0382	25-AO 10 R	25	35	12.5	M12	55	✓	4	r	AOFT 10 03
1348.0422	32-AO 10 R	32	42	17	M16	64	✓	5	r	AOFT 10 03

*while stocks last

Tool will be delivered with holder, all screws and screw-driver, but without indexable inserts.

Helical milling (B = Recommended pitch per helical rotation)

AO10 TWIST 481 581	Ø D	B	min Ø	max Ø
	16	0.4	22	31
	20	0.4	30	39
	25	0.4	40	49
	32	0.4	54	63

Plunging and ramping

AO10 TWIST 481 581	Ø D	az	β
	16	0.4	2.9°
	20	0.4	1.9°
	25	0.4	1.3°
	32	0.4	0.9°

Accessories / spare parts

Part No	Torx screw				Screw-driver	
	Qty	Article	Type	Torque	Article	Type
1347.0300	2	1491.0210	M2.5 x 4	0.95 Nm	1493.0300	TP7 IP
1348.0300	2	1491.0210	M2.5 x 4	0.95 Nm	1493.0300	TP7 IP
1347.0338	2	1491.0220	M2.5 x 5	0.95 Nm	1493.0300	TP7 IP
1347.0340	3	1491.0220	M2.5 x 5	0.95 Nm	1493.0300	TP7 IP
1348.0340	3	1491.0220	M2.5 x 5	0.95 Nm	1493.0300	TP7 IP
1347.0382	4	1491.0220	M2.5 x 5	0.95 Nm	1493.0300	TP7 IP
1348.0382	4	1491.0220	M2.5 x 5	0.95 Nm	1493.0300	TP7 IP
1348.0422	5	1491.0220	M2.5 x 5	0.95 Nm	1493.0300	TP7 IP

Info The flat Kappa angle of around 15° allows a very high feed per tooth.

Info By exchanging the indexable inserts, this milling tool can also be used as a step milling cutter.

Info This tool mainly generates forces in axial direction, which allows big protrudings and preserves the spindle.

Info The same TWIST milling bodies as for profile milling 90° can be used with 481/581 inserts.



Face milling



Profile milling



Circular
plunge milling



Circular
interpolation



Ramping

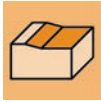

ALESA TWIST high feed cutter

AO 10 / Ø 16 - 32



High feed milling

Cutting material	Coating	Part No	ISO Code	d mm	s mm	d1 mm			Werkstoffklassen						
									1	2	3	4	5	6	
Carbide HM	AlCrN	1288.0300	AOFT 10 03 ZZ FR-481	7	3.35	2.8	●	○	●	○	●	○	●	○	●
Carbide HM-F	AlCrN	1288.0500*	AOFT 10 03 ZZ FR-581	7	3.35	2.8		●	●	○	●	○			
Carbide HA	TiNox	1288.0700	AOFT 10 03 ZZ FR-681	7	3.35	2.8	●	○	○	●			●		

Fitting instructions for inserts see page 136

*while stocks last

Overview of all indexable inserts see page 106 and following.







ALESA TWIST high feed cutter

AO 10 / Ø 32 - 50

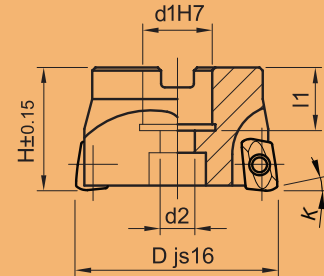
1311

High feed milling



Part No	Type	D mm	H mm	d1 mm	d2 mm	l1 mm				WSP
1311.0422	32-AO 10 R	32	28	13	6.5	15	✓	5	r	AOFT 10 03
1311.0462	40-AO 10 R	40	32	16	8.5	18	✓	6	r	AOFT 10 03
1311.0482	50-AO 10 R	50	40	22	11	20	✓	8	r	AOFT 10 03

*while stocks last

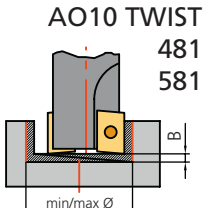

Tool will be delivered with holder, all screws and screw-driver, but without indexable inserts.

Helical milling (B = Recommended pitch per helical rotation)

AO10 TWIST 481 581	Ø D	B	min Ø	max Ø
		32	0.4	54
	40	0.4	70	79
	50	0.4	90	99

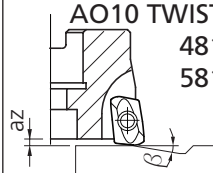
Plunging and ramping

AO10 TWIST 481 581	Ø D	az	β
		32	0.40
	40	0.40	0.7°
	50	0.40	0.5°

Part No	 Torx screw				 Screw-driver		 Hex socket head screw		
	Qty	Article	Type	Torque	Article	Type	Article	Type	Torque
1311.0422	5	1491.0220	M2.5 x 5	0.95 Nm	1493.0300	TP7 IP	1490.0750	M6 x 20	10 Nm
1311.0462	6	1491.0220	M2.5 x 5	0.95 Nm	1493.0300	TP7 IP	1490.0759	M8 x 20	30 Nm
1311.0482	8	1491.0220	M2.5 x 5	0.95 Nm	1493.0300	TP7 IP	1490.0770	M10 x 25	50 Nm

Info The flat Kappa angle of around 15° allows a very high feed per tooth.

Info By exchanging the indexable inserts, this milling tool can also be used as a step milling cutter.

Info This tool mainly generates forces in axial direction, which allows big protrudings and preserves the spindle.

Info The same TWIST milling bodies as for profile milling 90° can be used with 481/581 inserts.



Face milling



Profile milling



Circularly
plunge milling



Circular
interpolation



Ramping

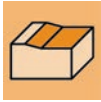

ALESA TWIST high feed cutter

AO 10 / Ø 32 - 50



High feed milling

Cutting material	Coating	Part No	ISO Code	d mm	s mm	d1 mm			Werkstoffklassen						
									1	2	3	4	5	6	
Carbide HM	AlCrN	1288.0300	AOFT 10 03 ZZ FR-481	7	3.35	2.8	●	○	●	○	●	○	●	○	●
Carbide HM-F	AlCrN	1288.0500*	AOFT 10 03 ZZ FR-581	7	3.35	2.8		●	●	○	●	○			
Carbide HA	TiNox	1288.0700	AOFT 10 03 ZZ FR-681	7	3.35	2.8	●	○	○	●			●		

Fitting instructions for inserts see page 136

*while stocks last

Overview of all indexable inserts see page 106 and following.

Milling with button inserts

ALESA RP 12

The characteristics

- THE classic of bolted button insert tools with RP 12 cutting inserts
- High positive ALESA sharp-ground inserts
- SWISS Precision Tool. The milling head and cutting inserts are manufactured in Switzerland
- Robust and proven solution according to DIN
- The sharp edges require less spindle power than pure sintered cutting insert
- The sharp-ground cutting inserts are optimized for modern 5-axis milling centers
- The RP 12 tools \varnothing 40 mm to \varnothing 100 mm are equipped with cooling holes for internal coolant supply
- The RP 12 tools with \varnothing 125 mm and \varnothing 160 mm can be provided with coolant distribution rings, which contain an internal coolant supply
- The best PVD coatings are available
- HSS and carbide cutting inserts are available from the warehouse

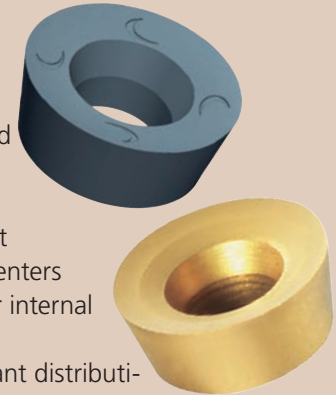

The benefits and options for you

- Fast delivery from the Seengen warehouse
- Arbor type from \varnothing 40 mm to \varnothing 160 mm
- With 3 cutting geometries a very large range of materials can be processed
- HSS cutting inserts with TiN and TiAlN coatings are safe and efficient for the processing of many applications
- High chip removal rate (Q) with a relatively small machine load
- Good tool life and high productivity
- RP 12 cutting inserts are very efficient for face milling at cutting depths (ap) up to 2 mm
- The latest developments show excellent cutting processes with the most difficult Ni-, Ti- and Co- alloys
- Manufactured according to ISO certified processes
- For special tools, our construction with large experience is available



Milling with button inserts

Milling with button inserts

ALESA RP 06/08/10

ALESA threaded type cutter RP 06/08/10

- Like the RP round insert cutter, the threaded type cutters are also available for inserts 06 / 08 and 10
- All ALESA's cutting inserts are high positive and sharp ground
- SWISS Precision Tool. The heads and cutting inserts are manufactured in Switzerland
- The sharp edges create less cutting forces and require less spindle performance than pure sintered cutting inserts
- The sharp ground cutting inserts are optimized for modern 5-axis milling centers
- The RD threaded type cutters are available from the warehouse in Ø 12 mm with RD 06, in Ø 16 mm with RD 08 and in Ø 20 mm with RD 10
- For the carbide RD cutting inserts, different powerful PVD coatings are available
- Fast delivery from the Seengen warehouse
- Manufactured according to ISO certified processes
- For special tools, our construction with great experience is available



ALESA RP 06/08/10

- Based on the classic button inserts, ALESA also delivers RP cutting inserts in sizes 06 / 08 and 10
- All ALESA's cutting inserts are high positive and sharp ground
- SWISS Precision Tool. The milling heads and cutting inserts are manufactured in Switzerland
- The sharp edges create less cutting forces and require less spindle power than pure sintered milling inserts
- The sharp ground cutting inserts are optimized for modern 5-axis milling centers
- The RP Weldon end mills are available from the warehouse in the Ø 16 mm and Ø 20 mm with RP 06, in Ø 25 mm with RP 08 and in Ø 32 mm with RP 10
- All RP tools are provided with coolant holes for internal coolant supply
- The best PVD coatings are available
- The RP cutting inserts are available in HSS and carbide



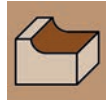

ALESA end mill and threaded type cutter RP

RP 06 / 08 / 10 R / Ø 16 - 32

1326 / 1327

Milling with button inserts



Part No	Type	D mm	D1 mm	l2 mm	G	d2 mm	l1 mm	ap mm				WSP
1326.0240	12-RP 06 R	6	12	20	M6	6.5	33	3	✓	2	r	RPFT 06 02
1327.0300	16-RP 06 R	10	16	58		16	108	3	✓	2	r	RPFT 06 02
1326.0300	16-RP 08 R	8	16	25	M8	8.5	41	4	✓	2	r	RPFT 08 03
1327.0340	20-RP 06 R	14	20	58		20	110	3	✓	3	r	RPFT 06 02
1326.0340	20-RP 10 R	10	20	30	M10	10.5	48	5	✓	2	r	RPFT 10 T3
1327.0380	25-RP 08 R	17	25	68		25	126	4	✓	3	r	RPFT 08 03
1327.0420	32-RP 10 R	22	32	68		32	130	5	✓	3	r	RPFT 10 T3

Tool will be delivered with holder, all screws and screw-driver, but without indexable inserts.

Helical milling (B = Recommended pitch per helical rotation)

RP06 08 10	Ø D	B	min Ø	max Ø
	12 RP06	0.5	18	23
16 RP06	0.5	26	31	
16 RP08	1.0	24	31	
20 RP06	0.5	34	39	
20 RP10	1.5	30	39	
25 RP08	1.0	42	49	
32 RP10	1.5	54	63	

Plunging and ramping

RP06 08 10	Ø D	az	β
	12 RP06	0.20	2.2°
16 RP06	0.30	1.9°	
16 RP08	0.45	4.2°	
20 RP06	0.70	3.3°	
20 RP10	0.65	5.0°	
25 RP08	1.60	6.7°	
32 RP10	2.10	6.7°	

Accessories / spare parts

Part No	Torx screw				Screw-driver	
	Qty	Article	Type	Torque	Article	Type
1326.0240	2	1491.0210	M2.5 x 4	0.95 Nm	1493.0300	TP7 IP
1327.0300	2	1491.0220	M2.5 x 5	0.95 Nm	1493.0300	TP7 IP
1326.0300	3	1490.0240	M3 x 6	1.65 Nm	1492.0400	T9
1327.0340	3	1491.0220	M2.5 x 5	0.95 Nm	1493.0300	TP7 IP
1326.0340	2	1490.0320	M4 x 6	3.85 Nm	1492.0500	T15
1327.0380	3	1490.0240	M3 x 6	1.65 Nm	1492.0400	T9
1327.0420	3	1490.0340	M4 x 8	3.85 Nm	1492.0500	T15

WSP

All ALESA indexable inserts are ground in the high ISO standard tolerance classification F.



Holes for internal coolant supply guarantee ideal cooling.



Highly positive, extremely sharp cutting edge of HSS-E and carbide.



Face milling



Circular plunge milling



Circular interpolation



Ramping



Profiling



Multipass milling

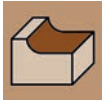

ALESA end mill and threaded type cutter RP

RP 06 / 08 / 10 R / Ø 16 - 32



Milling with button inserts

Cutting material	Coating	Part No	ISO Code	d mm	s mm	d1 mm	γ	[Symbol]	[Symbol]	[Symbol]	Werkstoffklassen					
											1	2	3	4	5	6
HSS-E	TiN	1076.0200	RPFT 06 02 M0	6	2.38	3	20°	r/l	●			○	○		●	●
		1076.0240	RPFT 08 03 M0	8	3.18	3.6	20°	r/l	●			○	○		●	●
		1076.0300	RPFT 10 T3 M0	10	3.97	4.5	20°	r/l	●			○	○		●	●
	TiAlN	1151.0200	RPFT 06 02 M0	6	2.38	3	20°	r/l	●			○	●		●	○
		1151.0240	RPFT 08 03 M0	8	3.18	3.6	20°	r/l	●			○	●		●	○
		1151.0300	RPFT 10 T3 M0	10	3.97	4.5	20°	r/l	●			○	●		●	○
Carbide MG20	TiN	1276.0200	RPFT 06 02 M0-111	6	2.38	3	20°	r/l	○	●		●	○	●	●	●
		1276.0240	RPFT 08 03 M0-111	8	3.18	3.6	20°	r/l	○	●		●	○	●	●	●
		1276.0300	RPFT 10 T3 M0-111	10	3.97	4.5	20°	r/l	○	●		●	○	●	●	●
	TiAlN	1276.0205	RPFT 06 02 M0-111	6	2.38	3	20°	r/l	○	●		●	○	●	●	●
		1276.0245	RPFT 08 03 M0-111	8	3.18	3.6	20°	r/l	○	●		●	○	●	●	●
		1276.0305	RPFT 10 T3 M0-111	10	3.97	4.5	20°	r/l	○	●		●	○	●	●	●
	AlCrN	1276.0215	RPFT 06 02 M0-111	6	2.38	3	20°	r/l	○	●		●	○	●	○	●
		1276.0217	RPFT 06 02 M0-131	6	2.38	3	8°	r/l	○	●		●	○	●	○	●
		1276.0255	RPFT 08 03 M0-111	8	3.18	3.6	20°	r/l	○	●		●	○	●	○	●
		1276.0257	RPFT 08 03 M0-131	8	3.18	3.6	8°	r/l	○	●		●	○	●	○	●
		1276.0315	RPFT 10 T3 M0-111	10	3.97	4.5	20°	r/l	○	●		●	○	●	○	●
		1276.0317	RPFT 10 T3 M0-131	10	3.97	4.5	8°	r/l	○	●		●	○	●	○	●
		1276.0222	RPFT 06 02 M0-131	6	2.38	3	8°	r/l	○	●		●	○	●	○	●
		1276.0262	RPFT 08 03 M0-131	8	3.18	3.6	8°	r/l	○	●		●	○	●	○	●
		1276.0322	RPFT 10 T3 M0-131	10	3.97	4.5	8°	r/l	○	●		●	○	●	○	●

Fitting instructions for inserts see page 136

Zusatznummer Wendeschneidplatten ISO-Code (Schneidengeometrie)
 Additional number indexable inserts ISO-code (cutting geometry)
 Numéro supplémentaire plaquettes amovibles code ISO (géométrie de coupe)

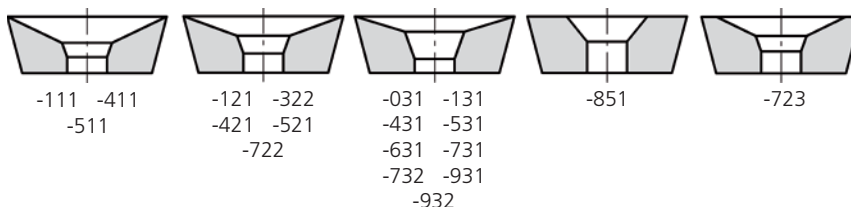

Overview of all indexable inserts see page 106 and following.

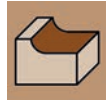

ALESA milling cutter RP

RP 12 R / Ø 40 - 160

1301

Milling with button inserts



1301.0520

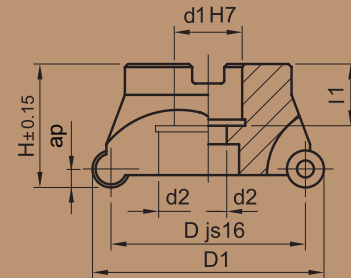

Part No	Type	D mm	D1 mm	H mm	d1 mm	d2 mm	l1 mm	ap mm				WSP
1301.0460	40-RP 12 R	40	52	32	16	8.5	18	6	✓	4	r	RP.T 12 04
1301.0480	50-RP 12 R	50	62	40	22	11	20	6	✓	4	r	RP.T 12 04
1301.0500	63-RP 12 R	63	75	40	22	11	20	6	✓	5	r	RP.T 12 04
1301.0520	80-RP 12 R	80	92	50	27	14	22	6	✓	6	r	RP.T 12 04
1301.0540	100-RP 12 R	100	112	50	32	18	25	6	✓	7	r	RP.T 12 04
1301.0560	125-RP 12 R	125	137	63	40	56	28	6		8	r	RP.T 12 04
1301.0580	160-RP 12 R	160	172	63	40	56	28	6		10	r	RP.T 12 04

*while stocks last

Helical milling (B = Recommended pitch per helical rotation)

RP12	Ø D	B	min/max Ø	
			min Ø	max Ø
	40	2.0	88	103
	50	2.0	108	123
	63	2.0	134	149
	80	2.0	168	183
	100	2.0	208	223
	125	2.0	258	273
	160	2.0	328	343

Plunging and ramping

RP12	Ø D	az	β
	50	2.2	2.7°
	63	2.2	2.1°
	80	2.2	1.6°
	100	2.2	1.3°
	125	2.2	1.0°
	160	2.2	0.8°

Part No	Torx screw				Screw-driver		Hex socket head screw		
	Qty	Article	Type	Torque	Article	Type	Article	Type	Torque
1301.0460	4	1490.0380	M4 x 11	3.85 Nm	1492.0600	T20	1490.0759	M8 x 20	30 Nm
1301.0480	4	1490.0380	M4 x 11	3.85 Nm	1492.0600	T20	1490.0770	M10 x 25	50 Nm
1301.0500	5	1490.0380	M4 x 11	3.85 Nm	1492.0600	T20	1490.0770	M10 x 25	50 Nm
1301.0520	6	1490.0380	M4 x 11	3.85 Nm	1492.0600	T20	1490.0780	M12 x 30	90 Nm
1301.0540	7	1490.0380	M4 x 11	3.85 Nm	1492.0600	T20	1490.0789	M16 x 30	160 Nm
1301.0560	8	1490.0380	M4 x 11	3.85 Nm	1492.0600	T20			
1301.0580	10	1490.0380	M4 x 11	3.85 Nm	1492.0600	T20			

WSP

All ALESA indexable inserts are ground in the high ISO standard tolerance classification F.



Holes for internal coolant supply guarantee ideal cooling.



Face milling



Circular plunge milling



Circular interpolation



Ramping



Profiling



Multipass milling

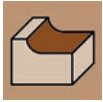

ALESA milling cutter RP

RP 12 R / Ø 40 - 160



Milling with button inserts

Cutting material	Coating	Part No	ISO Code	γ				Werkstoffklassen					
								1	2	3	4	5	6
HSS-E	TiN	1076.0400	RPFT 12 04 M0	20°	r/l	●		○	○		●		●
		1076.0410	RPFT 12 04 M0	30°	r/l	●		○	○		●		●
	TiAlN	1151.0400	RPFT 12 04 M0	20°	r/l	●		○	●		●	○	●
		1151.0410	RPFT 12 04 M0	30°	r/l	●		○	●		●	○	●
Carbide MG20	TiN	1276.0400	RPFT 12 04 M0-111	20°	r/l	○	●	●	○	●	●		●
	TiAlN	1276.0405	RPFT 12 04 M0-111	20°	r/l	○	●	●	○	●	●		●
	AlCrN	1276.0415	RPFT 12 04 M0-111	20°	r/l	○	●	●	○	●	●		●
Carbide 12CR	TiAlN	1276.0420*	RPHT 12 04 M0-222	16°	r/l	○	●	●	○	●	○	●	
		1276.0430*	RPHT 12 04 M0-222	16°	r/l	○	●	●	○	●	○	●	
	AlCrN	1276.0530*	RPFT 12 04 M0-231	6°	r/l	○	●	●	○	●	○	●	
		1276.0535*	RPFT 12 04 M0-231	6°	r/l	○	●	●	○	●	○	●	
Carbide CTS-X	TiNox	1276.0540	RPHT 12 04 M0-722	16°	r/l	●	○	○	○	○	○	○	
		1276.0560	RPFT 12 04 M0-731	6°	r/l	●	○	○	○	○	○	○	

Fitting instructions for inserts see page 136

*while stocks last

Zusatznummer Wendeschneidplatten ISO-Code (Schneidengeometrie)
 Additional number indexable inserts ISO-code (cutting geometry)
 Numéro supplémentaire plaquettes amovibles code ISO (géométrie de coupe)

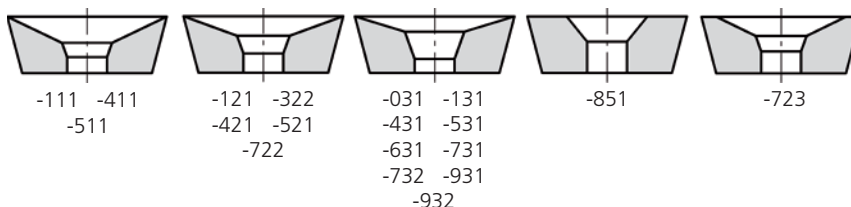

Overview of all indexable inserts see page 106 and following.

Notes



Turning tools

Turning					
					
SR	SC 06	SC 09	SD	SV 16	SA
16 - 32	8 - 10	12 - 16	10 - 20	25	12 - 25
No 1905	No 1910	No 1910	No 1920	No 1935	No 1940
p. 70	p. 72	p. 74	p. 76	p. 78	p. 80
					
SS					
12 - 25					
No 1945					
p. 82					

Turning inside		
		
SC 06 / 09	SM	SD
Ø 8 - 20	Ø 6 - 8	Ø 12 - 20
No 1917	No 1918	No 1927
p. 84	p. 86	p. 88

Toolbits		
		
round	square	rectangular
Ø 2 - 30	4x4 - 32x32	6x4 - 32x20
No 4120	No 4140	No 4160
p. 90	p. 91	p. 92

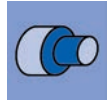

ALESA toolholder SR for turning

RCFT / 16 - 32

1905

Turning



Part No	Type	h2 mm	b mm	l1 mm	h1 mm	f mm	l2 mm	↻	Article	Type	Article	Type	WSP
1905.0200	SRDCN 16 16 06	16	16	100	16		12	n	1491.0220	M2.5x5 / 0.95Nm	1493.0300	TP7 IP	RCFT 06
1905.0300	SRSCR 16 16 06	16	16	100	16	20	16	r	1491.0220	M2.5x5 / 0.95Nm	1493.0300	TP7 IP	RCFT 06
1905.0305	SRSCN 16 16 06	16	16	100	16	20	16	l	1491.0220	M2.5x5 / 0.95Nm	1493.0300	TP7 IP	RCFT 06
1905.0220	SRDCN 20 20 08	20	20	125	20		16	n	1490.0240	M3x6 / 1.65Nm	1492.0400	T 9	RCFT 08
1905.0320	SRSCR 20 20 08	20	20	125	20	25	20	r	1490.0240	M3x6 / 1.65Nm	1492.0400	T 9	RCFT 08
1905.0325	SRSCN 20 20 08	20	20	125	20	25	20	l	1490.0240	M3x6 / 1.65Nm	1492.0400	T 9	RCFT 08
1905.0240	SRDCN 20 20 10	20	20	125	20		22	n	1490.0360	M4x10 / 3.85Nm	1492.0500	T 15	RCFT 10
1905.0340	SRSCR 20 20 10	20	20	125	20	25	20	r	1490.0360	M4x10 / 3.85Nm	1492.0500	T 15	RCFT 10
1905.0345	SRSCN 20 20 10	20	20	125	20	25	20	l	1490.0360	M4x10 / 3.85Nm	1492.0500	T 15	RCFT 10
1905.0260	SRDCN 25 25 12	25	25	150	25		24	n	1490.0400	M5x16 / 5.00Nm	1492.0600	T 20	RCFT 12
1905.0360	SRSCR 25 25 12	25	25	150	25	32	25	r	1490.0400	M5x16 / 5.00Nm	1492.0600	T 20	RCFT 12
1905.0365	SRSCN 25 25 12	25	25	150	25	32	25	l	1490.0400	M5x16 / 5.00Nm	1492.0600	T 20	RCFT 12
1905.0280	SRDCN 32 25 16	32	25	170	32		28	n	1490.0400	M5x16 / 5.00Nm	1492.0600	T 20	RCFT 16
1905.0290	SRDCN 32 32 20	32	32	170	32		32	n	1490.0420	M6x18 / 6.00Nm	4390.0540	SW 4	RCFT 20
1905.0400*	SRSCR 32 32 20	32	32	170	32	40	32	r	1490.0420	M6x18 / 6.00Nm	4390.0540	SW 4	RCFT 20
1905.0405*	SRSCN 32 32 20	32	32	170	32	40	32	l	1490.0420	M6x18 / 6.00Nm	4390.0540	SW 4	RCFT 20

*while stocks last

Tool will be delivered with holder, all screws and screw-driver, but without indexable inserts.



Rigid roughing tool with a strong insert for turning.



Good cooling increases tool life.



All ALESA indexable inserts are ground in the high ISO standard tolerance classification F.



Turning



Face turning



Turning a shoulder



Profile turning



Relieving

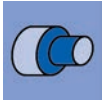

ALESA toolholder SR for turning RCFT / 16 - 32

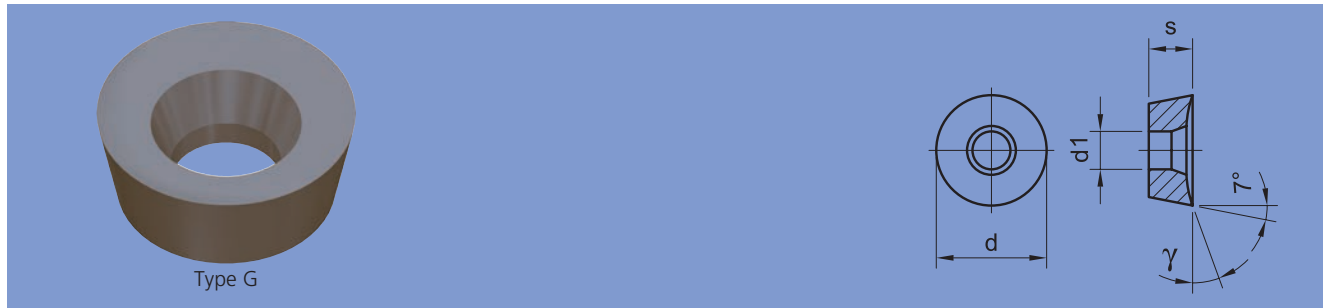

Turning

Cutting material	Coating	Part No	ISO Code	Type G/K	d mm	s mm	d1 mm	γ				Werkstoffklassen							
												1	2	3	4	5	6		
HSS-E	TiN	1576.0200	RCFT 06 02 M0	G	6	2.38	3	25°	r/l	●			○	○		●		●	
		1576.0240	RCFT 08 03 M0	G	8	3.18	3.6	25°	r/l	●				○	○		●		●
		1576.0300	RCFT 10 T3 M0	G	10	3.97	4.5	25°	r/l	●				○	○		●		●
		1576.0400	RCFT 12 04 M0	G	12	4.76	5.5	25°	r/l	●				○	○		●		●
		1576.0500	RCFT 16 06 M0	G	16	6.35	5.5	25°	r/l	●				○	○		●		●
		1576.0600	RCFT 20 06 M0	G	20	6.35	6.5	25°	r/l	●				○	○		●		●
	TiAlN	1651.0200	RCFT 06 02 M0	G	6	2.38	3	25°	r/l	●				○	●		●	○	●
		1651.0240	RCFT 08 03 M0	G	8	3.18	3.6	25°	r/l	●				○	●		●	○	●
		1651.0300	RCFT 10 T3 M0	G	10	3.97	4.5	25°	r/l	●				○	●		●	○	●
		1651.0400	RCFT 12 04 M0	G	12	4.76	5.5	25°	r/l	●				○	●		●	○	●
		1651.0500	RCFT 16 06 M0	G	16	6.35	5.5	25°	r/l	●				○	●		●	○	●
		1651.0600	RCFT 20 06 M0	G	20	6.35	6.5	25°	r/l	●				○	●		●	○	●

Overview of all indexable inserts see page 106 and following.



ALESA toolholder SC 06 for turning

CCFT 06 / 08 - 10

1910 - 06

Turning



1910.0220

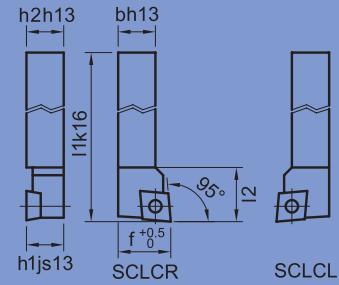

Part No	Type	h2 mm	b mm	l1 mm	h1 mm	f mm	l2 mm	↻	Article	Type	Article	Type	WSP
1910.0200	SCLCR 08 08 06	8	8	60	8	10	9	r	1491.0220	M2.5x5 / 0.95Nm	1493.0300	TP7 IP	CCFT 06
1910.0205	SCLCL 08 08 06	8	8	60	8	10	9	l	1491.0220	M2.5x5 / 0.95Nm	1493.0300	TP7 IP	CCFT 06
1910.0220	SCLCR 10 10 06	10	10	70	10	12	9	r	1491.0220	M2.5x5 / 0.95Nm	1493.0300	TP7 IP	CCFT 06
1910.0225	SCLCL 10 10 06	10	10	70	10	12	9	l	1491.0220	M2.5x5 / 0.95Nm	1493.0300	TP7 IP	CCFT 06

Tool will be delivered with holder, all screws and screw-driver, but without indexable inserts.

Info The all purpose turning tool

WSP Indexable insert type K for a controlled chip or as chip-breaker.

Info The highly positive cutting geometries reduce the cutting forces considerably.

Info On a holder right: for longitudinal turning use inserts right, for face turning use inserts left. Holder left vice versa.



Turning



Face turning



Turning a shoulder



ALESA toolholder SC 06 for turning

CCFT 06 / 08 - 10

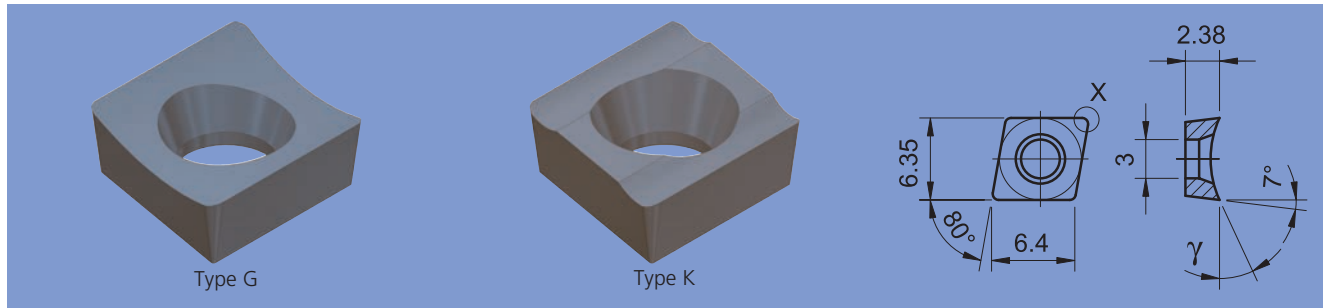

Turning

Cutting material	Coating	Part No	ISO Code	Type G/K	γ	Detail X				Werkstoffklassen					
										1	2	3	4	5	6
HSS-E	TiN	1578.0245	CCFT 06 02 01 FR	G	20°	R 0.1	r	●		○	○		●	●	
		1578.0247	CCFT 06 02 01 FL	G	20°	R 0.1	l	●		○	○		●	●	
		1578.0250	CCFT 06 02 02 FR	G	20°	R 0.2	r	●		○	○		●	●	
		1578.0252	CCFT 06 02 02 FL	G	20°	R 0.2	l	●		○	○		●	●	
		1578.0255	CCFT 06 02 04 FR	G	20°	R 0.4	r	●		○	○		●	●	
		1578.0257	CCFT 06 02 04 FL	G	20°	R 0.4	l	●		○	○		●	●	
		1578.0750	CCFT 06 02 02 FR	K	30°	R 0.2	r	●		○	○		●	●	
		1578.0752	CCFT 06 02 02 FL	K	30°	R 0.2	l	●		○	○		●	●	
		1578.0755	CCFT 06 02 04 FR	K	30°	R 0.4	r	●		○	○		●	●	
		1578.0757	CCFT 06 02 04 FL	K	30°	R 0.4	l	●		○	○		●	●	
		1653.0245	CCFT 06 02 01 FR	G	20°	R 0.1	r	●		○	●		●	○	●
		1653.0247	CCFT 06 02 01 FL	G	20°	R 0.1	l	●		○	●		●	○	●
		1653.0250	CCFT 06 02 02 FR	G	20°	R 0.2	r	●		○	●		●	○	●
		1653.0252	CCFT 06 02 02 FL	G	20°	R 0.2	l	●		○	●		●	○	●
	1653.0255	CCFT 06 02 04 FR	G	20°	R 0.4	r	●		○	●		●	○	●	
	1653.0257	CCFT 06 02 04 FL	G	20°	R 0.4	l	●		○	●		●	○	●	
	1653.0750	CCFT 06 02 02 FR	K	30°	R 0.2	r	●		○	●		●	○	●	
	1653.0752	CCFT 06 02 02 FL	K	30°	R 0.2	l	●		○	●		●	○	●	
	1653.0755	CCFT 06 02 04 FR	K	30°	R 0.4	r	●		○	●		●	○	●	
	1653.0757	CCFT 06 02 04 FL	K	30°	R 0.4	l	●		○	●		●	○	●	

Overview of all indexable inserts see page 106 and following.

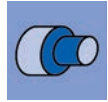

ALESA toolholder SC 09 for turning CCFT 09 / 12 -16

1910 - 09

Turning

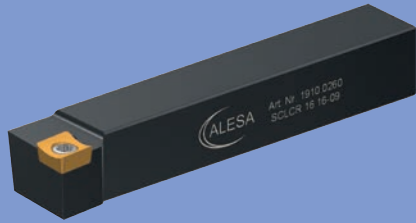

1910.0260

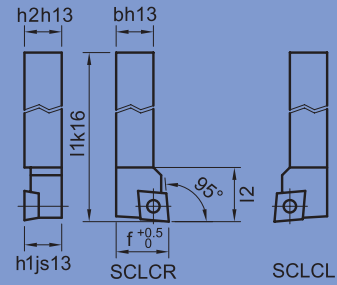

Part No	Type	h2 mm	b mm	l1 mm	h1 mm	f mm	l2 mm	↻	Article	Type	Article	Type	WSP
1910.0240	SCLCR 12 12 09	12	12	80	12	16	15	r	1490.0340	M4x8 / 3.85Nm	1492.0500	T 15	CCFT 09
1910.0245	SCLCL 12 12 09	12	12	80	12	16	15	l	1490.0340	M4x8 / 3.85Nm	1492.0500	T 15	CCFT 09
1910.0260	SCLCR 16 16 09	16	16	100	16	20	15	r	1490.0340	M4x8 / 3.85Nm	1492.0500	T 15	CCFT 09
1910.0265	SCLCL 16 16 09	16	16	100	16	20	15	l	1490.0340	M4x8 / 3.85Nm	1492.0500	T 15	CCFT 09

Tool will be delivered with holder, all screws and screw-driver, but without indexable inserts.

Info The all purpose turning tool

WSP Indexable insert type K for a controlled chip or as chip-breaker.

Info The highly positive cutting geometries reduce the cutting forces considerably.

Info On a holder right: for longitudinal turning use inserts right, for face turning use inserts left. Holder left vice versa.



Turning



Turning a shoulder



ALESA toolholder SC 09 for turning

CCFT 09 / 12 -16

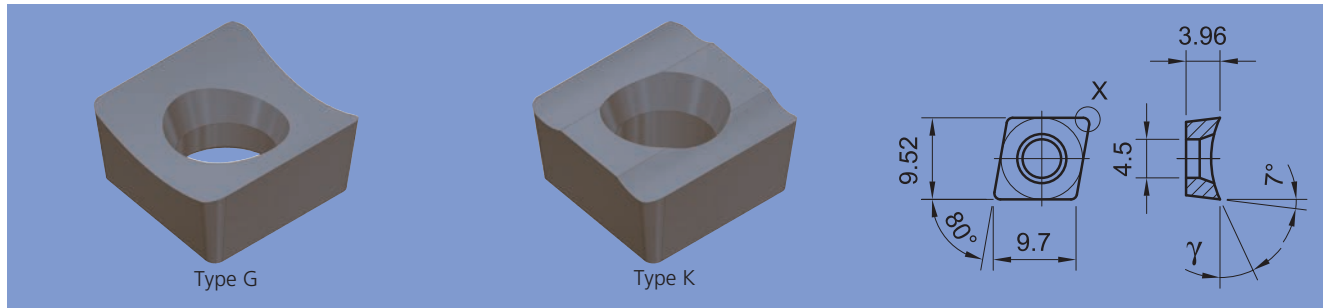

Turning

Cutting material	Coating	Part No	ISO Code	Type G/K	γ	Detail X				Werkstoffklassen					
										1	2	3	4	5	6
HSS-E	TiN	1578.0350	CCFT 09 T3 02 FR	G	25°	R 0.2	r	●		○	○		●	●	
		1578.0352	CCFT 09 T3 02 FL	G	25°	R 0.2	l	●		○	○		●	●	
		1578.0355	CCFT 09 T3 04 FR	G	25°	R 0.4	r	●		○	○		●	●	
		1578.0357	CCFT 09 T3 04 FL	G	25°	R 0.4	l	●		○	○		●	●	
		1578.0360	CCFT 09 T3 08 FR	G	25°	R 0.8	r	●		○	○		●	●	
		1578.0362	CCFT 09 T3 08 FL	G	25°	R 0.8	l	●		○	○		●	●	
		1578.0855	CCFT 09 T3 04 FR	K	30°	R 0.4	r	●		○	○		●	●	
		1578.0857	CCFT 09 T3 04 FL	K	30°	R 0.4	l	●		○	○		●	●	
		1578.0860	CCFT 09 T3 08 FR	K	30°	R 0.8	r	●		○	○		●	●	
		1578.0862	CCFT 09 T3 08 FL	K	30°	R 0.8	l	●		○	○		●	●	
	TiAlN	1653.0350	CCFT 09 T3 02 FR	G	25°	R 0.2	r	●		○	●		●	○	●
		1653.0352	CCFT 09 T3 02 FL	G	25°	R 0.2	l	●		○	●		●	○	●
		1653.0355	CCFT 09 T3 04 FR	G	25°	R 0.4	r	●		○	●		●	○	●
		1653.0357	CCFT 09 T3 04 FL	G	25°	R 0.4	l	●		○	●		●	○	●
		1653.0360	CCFT 09 T3 08 FR	G	25°	R 0.8	r	●		○	●		●	○	●
		1653.0362	CCFT 09 T3 08 FL	G	25°	R 0.8	l	●		○	●		●	○	●
		1653.0855	CCFT 09 T3 04 FR	K	30°	R 0.4	r	●		○	●		●	○	●
		1653.0857	CCFT 09 T3 04 FL	K	30°	R 0.4	l	●		○	●		●	○	●
		1653.0860	CCFT 09 T3 08 FR	K	30°	R 0.8	r	●		○	●		●	○	●
		1653.0862	CCFT 09 T3 08 FL	K	30°	R 0.8	l	●		○	●		●	○	●

Overview of all indexable inserts see page 106 and following.

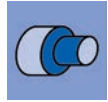

ALESA toolholder SD for turning

DCFT / 10 - 20

1920

Turning

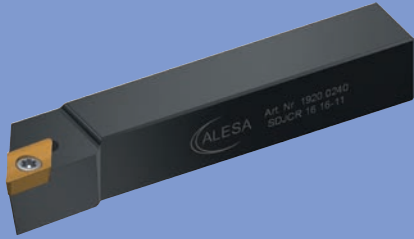

1920.0240

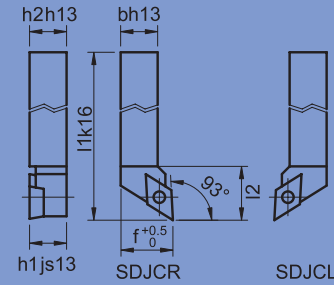

Part No	Type	h2 mm	b mm	l1 mm	h1 mm	f mm	l2 mm	↻	Article	Type	Article	Type	WSP
1920.0200	SDJCR 10 10 07	10	10	70	10	12	13	r	1491.0220	M2.5x5 / 0.95Nm	1493.0300	TP7 IP	DCFT 07
1920.0205	SDJCL 10 10 07	10	10	70	10	12	13	l	1491.0220	M2.5x5 / 0.95Nm	1493.0300	TP7 IP	DCFT 07
1920.0220	SDJCR 12 12 11	12	12	80	12	16	22	r	1490.0360	M4x10 / 3.85Nm	1492.0500	T 15	DCFT 11
1920.0225	SDJCL 12 12 11	12	12	80	12	16	22	l	1490.0360	M4x10 / 3.85Nm	1492.0500	T 15	DCFT 11
1920.0240	SDJCR 16 16 11	16	16	100	16	20	25	r	1490.0360	M4x10 / 3.85Nm	1492.0500	T 15	DCFT 11
1920.0245	SDJCL 16 16 11	16	16	100	16	20	25	l	1490.0360	M4x10 / 3.85Nm	1492.0500	T 15	DCFT 11
1920.0260	SDJCR 20 20 11	20	20	125	20	25	25	r	1490.0360	M4x10 / 3.85Nm	1492.0500	T 15	DCFT 11
1920.0265	SDJCL 20 20 11	20	20	125	20	25	25	l	1490.0360	M4x10 / 3.85Nm	1492.0500	T 15	DCFT 11

Tool will be delivered with holder, all screws and screw-driver, but without indexable inserts.

Info

Ideal cutting geometries and coating for stainless and acidproof steels with a high nickel and chrome content.



Good cooling increases tool life.

Info

The perfect tool for profile turning and finishing.

WSP

Indexable insert type K for a controlled chip or as chip-breaker.



Turning



Turning a shoulder



Profile turning



Relieving



ALESA toolholder SD for turning

DCFT / 10 - 20

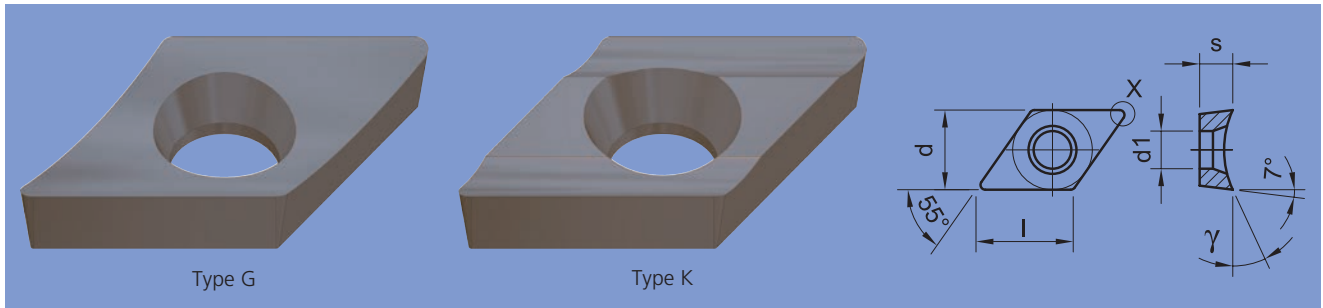

Turning

Cutting material	Coating	Part No	ISO Code	Type G/K	d mm	s mm	l mm	d1 mm	γ	Detail X		Werkstoffklassen					
												1	2	3	4	5	6
HSS-E	TiN	1579.0245	DCFT 07 02 01 FR	G	6.35	2.38	7.75	3	20°	R 0.1	r	○	○	●	○	●	
		1579.0247	DCFT 07 02 01 FL	G	6.35	2.38	7.75	3	20°	R 0.1	l	○	○	●	○	●	
		1579.0250	DCFT 07 02 02 FR	G	6.35	2.38	7.75	3	20°	R 0.2	r	○	○	●	○	●	
		1579.0252	DCFT 07 02 02 FL	G	6.35	2.38	7.75	3	20°	R 0.2	l	○	○	●	○	●	
		1579.0255	DCFT 07 02 04 FR	G	6.35	2.38	7.75	3	20°	R 0.4	r	○	○	●	○	●	
		1579.0257	DCFT 07 02 04 FL	G	6.35	2.38	7.75	3	20°	R 0.4	l	○	○	●	○	●	
		1579.0355	DCFT 11 T3 04 FR	G	9.52	3.96	11.6	4.5	25°	R 0.4	r	○	○	●	○	●	
		1579.0357	DCFT 11 T3 04 FL	G	9.52	3.96	11.6	4.5	25°	R 0.4	l	○	○	●	○	●	
		1579.0360	DCFT 11 T3 08 FR	G	9.52	3.96	11.6	4.5	25°	R 0.8	r	○	○	●	○	●	
		1579.0362	DCFT 11 T3 08 FL	G	9.52	3.96	11.6	4.5	25°	R 0.8	l	○	○	●	○	●	
		1579.0750	DCFT 07 02 02 FR	K	6.35	2.38	7.75	3	30°	R 0.2	r	○	○	●	○	●	
		1579.0752	DCFT 07 02 02 FL	K	6.35	2.38	7.75	3	30°	R 0.2	l	○	○	●	○	●	
		1579.0755	DCFT 07 02 04 FR	K	6.35	2.38	7.75	3	30°	R 0.4	r	○	○	●	○	●	
		1579.0757	DCFT 07 02 04 FL	K	6.35	2.38	7.75	3	30°	R 0.4	l	○	○	●	○	●	
		1579.0855	DCFT 11 T3 04 FR	K	9.52	3.96	11.6	4.5	30°	R 0.4	r	○	○	●	○	●	
		1579.0857	DCFT 11 T3 04 FL	K	9.52	3.96	11.6	4.5	30°	R 0.4	l	○	○	●	○	●	
		1579.0860	DCFT 11 T3 08 FR	K	9.52	3.96	11.6	4.5	30°	R 0.8	r	○	○	●	○	●	
		1579.0862	DCFT 11 T3 08 FL	K	9.52	3.96	11.6	4.5	30°	R 0.8	l	○	○	●	○	●	
	TiAlN	1654.0245	DCFT 07 02 01 FR	G	6.35	2.38	7.75	3	20°	R 0.1	r	○	●	●	○	●	
		1654.0247	DCFT 07 02 01 FL	G	6.35	2.38	7.75	3	20°	R 0.1	l	○	●	●	○	●	
		1654.0250	DCFT 07 02 02 FR	G	6.35	2.38	7.75	3	20°	R 0.2	r	○	●	●	○	●	
		1654.0252	DCFT 07 02 02 FL	G	6.35	2.38	7.75	3	20°	R 0.2	l	○	●	●	○	●	
		1654.0255	DCFT 07 02 04 FR	G	6.35	2.38	7.75	3	20°	R 0.4	r	○	●	●	○	●	
		1654.0257	DCFT 07 02 04 FL	G	6.35	2.38	7.75	3	20°	R 0.4	l	○	●	●	○	●	
		1654.0355	DCFT 11 T3 04 FR	G	9.52	3.96	11.6	4.5	25°	R 0.4	r	○	●	●	○	●	
		1654.0357	DCFT 11 T3 04 FL	G	9.52	3.96	11.6	4.5	25°	R 0.4	l	○	●	●	○	●	
		1654.0360	DCFT 11 T3 08 FR	G	9.52	3.96	11.6	4.5	25°	R 0.8	r	○	●	●	○	●	
		1654.0362	DCFT 11 T3 08 FL	G	9.52	3.96	11.6	4.5	25°	R 0.8	l	○	●	●	○	●	
		1654.0750	DCFT 07 02 02 FR	K	6.35	2.38	7.75	3	30°	R 0.2	r	○	●	●	○	●	
		1654.0752	DCFT 07 02 02 FL	K	6.35	2.38	7.75	3	30°	R 0.2	l	○	●	●	○	●	
		1654.0755	DCFT 07 02 04 FR	K	6.35	2.38	7.75	3	30°	R 0.4	r	○	●	●	○	●	
		1654.0757	DCFT 07 02 04 FL	K	6.35	2.38	7.75	3	30°	R 0.4	l	○	●	●	○	●	
		1654.0855	DCFT 11 T3 04 FR	K	9.52	3.96	11.6	4.5	30°	R 0.4	r	○	●	●	○	●	
		1654.0857	DCFT 11 T3 04 FL	K	9.52	3.96	11.6	4.5	30°	R 0.4	l	○	●	●	○	●	
1654.0860	DCFT 11 T3 08 FR	K	9.52	3.96	11.6	4.5	30°	R 0.8	r	○	●	●	○	●			
1654.0862	DCFT 11 T3 08 FL	K	9.52	3.96	11.6	4.5	30°	R 0.8	l	○	●	●	○	●			

Overview of all indexable inserts see page 106 and following.

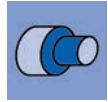

ALESA toolholder SV 16 for turning VCFT 16 / 25

1935

Turning



Part No	Type	h2 mm	b mm	l1 mm	h1 mm	f mm	l2 mm	↻	Article	Type	Article	Type	WSP
1935.0360	SVJCR 25 25 16	25	25	150	25	32	36	r	1490.0360	M4x10 / 3.85Nm	1492.0500	T 15	VCFT 16
1935.0365	SVJCL 25 25 16	25	25	150	25	32	36	l	1490.0360	M4x10 / 3.85Nm	1492.0500	T 15	VCFT 16

Tool will be delivered with holder, all screws and screw-driver, but without indexable inserts.

Info

The classical finishing tool.



Good cooling increases tool life.

WSP

Indexable insert type K for a controlled chip or as chip-breaker.

Info

The highly positive cutting geometries reduce the cutting forces considerably.



Turning



Turning a shoulder



Profile turning



Relieving



ALESA toolholder SV 16 for turning VCFT 16 / 25



Turning

Cutting material	Coating	Part No	ISO Code	Type G/K	γ	Detail X				Werkstoffklassen						
										1	2	3	4	5	6	
HSS-E	TiN	1582.0855	VCFT 16 04 04 FR	K	30°	R 0.4	r	●			○	○		●	●	
		1582.0857	VCFT 16 04 04 FL	K	30°	R 0.4	l	●			○	○		●	●	
		1582.0860	VCFT 16 04 08 FR	K	30°	R 0.8	r	●			○	○		●	●	
		1582.0862	VCFT 16 04 08 FL	K	30°	R 0.8	l	●			○	○		●	●	
	TiAlN	1657.0855	VCFT 16 04 04 FR	K	30°	R 0.4	r	●			○	●		●	○	●
		1657.0857	VCFT 16 04 04 FL	K	30°	R 0.4	l	●			○	●		●	○	●
		1657.0860	VCFT 16 04 08 FR	K	30°	R 0.8	r	●			○	●		●	○	●
		1657.0862	VCFT 16 04 08 FL	K	30°	R 0.8	l	●			○	●		●	○	●

Overview of all indexable inserts see page 106 and following.

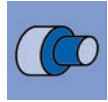

ALESA toolholder SA 16 for turning

APFT 16 / 12 - 25

1940

Turning

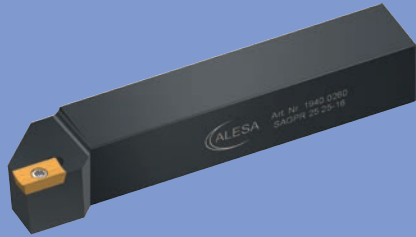

1940.0260

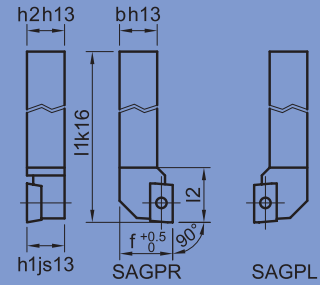

Part No	Type	h2 mm	b mm	l1 mm	h1 mm	f mm	l2 mm	↻	Article	Type	Article	Type	WSP
1940.0200	SAGPR 12 12 16	12	12	100	12	15	23	r	1490.0340	M4x8 / 3.85Nm	1492.0500	T 15	AP.T 16
1940.0205	SAGPL 12 12 16	12	12	100	12	15	23	l	1490.0340	M4x8 / 3.85Nm	1492.0500	T 15	AP.T 16
1940.0220	SAGPR 16 16 16	16	16	110	16	20	24	r	1490.0340	M4x8 / 3.85Nm	1492.0500	T 15	AP.T 16
1940.0225	SAGPL 16 16 16	16	16	110	16	20	24	l	1490.0340	M4x8 / 3.85Nm	1492.0500	T 15	AP.T 16
1940.0240	SAGPR 20 20 16	20	20	125	20	25	26	r	1490.0340	M4x8 / 3.85Nm	1492.0500	T 15	AP.T 16
1940.0245	SAGPL 20 20 16	20	20	125	20	25	26	l	1490.0340	M4x8 / 3.85Nm	1492.0500	T 15	AP.T 16
1940.0260	SAGPR 25 25 16	25	25	150	25	32	29	r	1490.0340	M4x8 / 3.85Nm	1492.0500	T 15	AP.T 16
1940.0265	SAGPL 25 25 16	25	25	150	25	32	29	l	1490.0340	M4x8 / 3.85Nm	1492.0500	T 15	AP.T 16

*while stocks last

Tool will be delivered with holder, all screws and screw-driver, but without indexable inserts.



Rigid roughing tool with a strong insert for turning.



Indexable insert type K for a controlled chip or as chip-breaker.



The tool for an excellent metal removal rate (cutting depth 16 mm).



Rectangular shoulder (90°) through the full length of cutting edge.



Turning



Turning a shoulder



ALESA toolholder SA 16 for turning

APFT 16 / 12 - 25

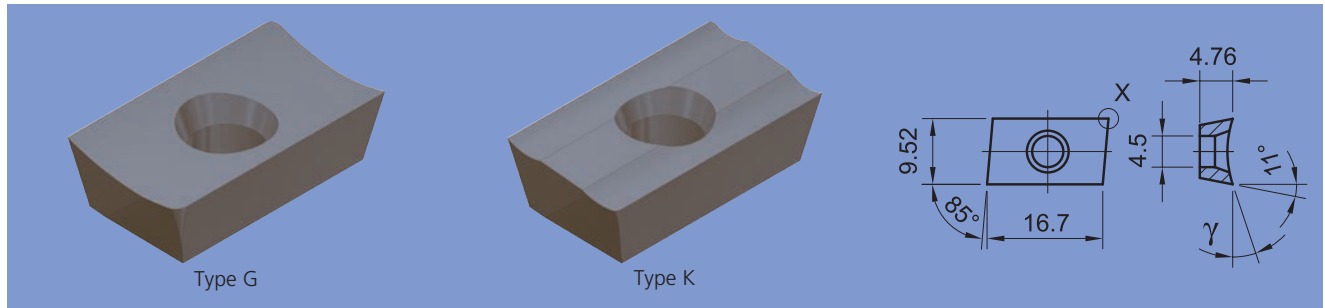

Turning

Cutting material	Coating	Part No	ISO Code	Type G/K	γ	Detail X				Werkstoffklassen					
										1	2	3	4	5	6
HSS-E	TiN	1085.0200	APFT 16 04 PD FR	G	18°	0.2x45°	r	●		○	○		●	●	
		1085.0210	APFT 16 04 PD FL	G	18°	0.2x45°	l	●		○	○		●	●	
		1085.0230	APFT 16 04 PD FR	G	25°	0.2x45°	r	●		○	○		●	●	
		1085.0250	APFT 16 04 04 FR	G	18°	R 0.4	r	●		○	○		●	●	
		1085.0260	APFT 16 04 04 FL	G	18°	R 0.4	l	●		○	○		●	●	
		1085.0300	APFT 16 04 08 FR	G	18°	R 0.8	r	●		○	○		●	●	
		1085.0310	APFT 16 04 08 FL	G	18°	R 0.8	l	●		○	○		●	●	
		1085.0350	APFT 16 04 12 FR	G	18°	R 1.2	r	●		○	○		●	●	
		1085.0360	APFT 16 04 12 FL	G	18°	R 1.2	l	●		○	○		●	●	
		1585.0700	APFT 16 04 PD FR	K	26°	0.2x45°	r	●		○	○		●	●	
	1585.0750	APFT 16 04 04 FR	K	26°	R 0.4	r	●		○	○		●	●		
	TiAlN	1160.0200	APFT 16 04 PD FR	G	18°	0.2x45°	r	●		○	●		●	○	●
		1160.0230	APFT 16 04 PD FR	G	25°	0.2x45°	r	●		○	●		●	○	●
		1160.0250	APFT 16 04 04 FR	G	18°	R 0.4	r	●		○	●		●	○	●
		1160.0300	APFT 16 04 08 FR	G	18°	R 0.8	r	●		○	●		●	○	●
1160.0350		APFT 16 04 12 FR	G	18°	R 1.2	r	●		○	●		●	○	●	
Carbide MG20	TiN	1285.0200	APFT 16 04 PD FR-111	G	18°	0.2x45°	r	○	●	●	○		●	●	
		1285.0250	APFT 16 04 04 FR-111	G	18°	R 0.4	r	○	●	●	○		●	●	
		1285.0300	APFT 16 04 08 FR-111	G	18°	R 0.8	r	○	●	●	○		●	●	
	TiAlN	1285.0205*	APFT 16 04 PD FR-111	G	18°	0.2x45°	r	○	●	●	○		●	●	
		1285.0255*	APFT 16 04 04 FR-111	G	18°	R 0.4	r	○	●	●	○		●	●	
	AlCrN	1285.0305*	APFT 16 04 08 FR-111	G	18°	R 0.8	r	○	●	●	○		●	●	
		1285.0215	APFT 16 04 PD FR-111	G	18°	0.2x45°	r	○	●	●	○		●	●	
		1285.0265	APFT 16 04 04 FR-111	G	18°	R 0.4	r	○	●	●	○		●	●	
	AlCrN-VA	1285.0315	APFT 16 04 08 FR-111	G	18°	R 0.8	r	○	●	●	○		●	●	
		1285.0515*	APFT 16 04 PD FR-121	G	10°	0.2x45°	r	○	●	●	○	●	●	○	●
		1285.0615*	APFT 16 04 08 FR-121	G	10°	R 0.8	r	○	●	●	○	●	●	○	●
		1285.0520*	APFT 16 04 PD FR-121	G	10°	0.2x45°	r	○	●	●	○	●	●	○	●
		1285.0620	APFT 16 04 08 FR-121	G	10°	R 0.8	r	○	●	●	○	●	●	○	●
Carbide 12CR	TiAlN	1285.0400*	APHT 16 04 PD FR-222	G	16°		r	●	●	●	○	●	○	●	
		1285.0410*	APHT 16 04 PD FR-222	G	16°		r	●	●	●	○	●	○	●	

*while stocks last

Overview of all indexable inserts see page 106 and following.

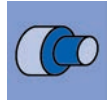

ALESA toolholder SS for turning

SCFT / 12 - 25

1945

Turning

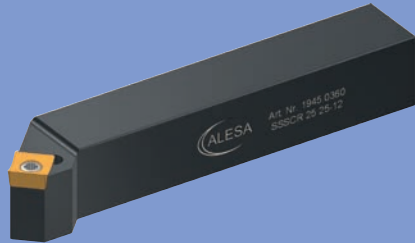

1945.0360

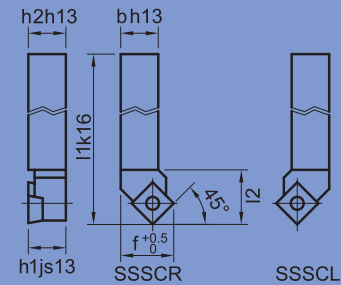

Part No	Type	h2 mm	b mm	l1 mm	h1 mm	f mm	l2 mm	↻	Article	Type	Article	Type	WSP
1945.0300	SSSCR 12 12 09	12	12	80	12	16	18	r	1490.0300	M3.5x10/2.55Nm	1492.0500	T 15	SCFT 09
1945.0305	SSSCL 12 12 09	12	12	80	12	16	18	l	1490.0300	M3.5x10/2.55Nm	1492.0500	T 15	SCFT 09
1945.0320	SSSCR 16 16 09	16	16	100	16	20	18	r	1490.0300	M3.5x10/2.55Nm	1492.0500	T 15	SCFT 09
1945.0325	SSSCL 16 16 09	16	16	100	16	20	18	l	1490.0300	M3.5x10/2.55Nm	1492.0500	T 15	SCFT 09
1945.0340	SSSCR 20 20 12	20	20	125	20	25	25	r	1490.0400	M5x16 / 5.00Nm	1492.0600	T 20	SCFT 12
1945.0345	SSSCL 20 20 12	20	20	125	20	25	25	l	1490.0400	M5x16 / 5.00Nm	1492.0600	T 20	SCFT 12
1945.0360	SSSCR 25 25 12	25	25	150	25	32	25	r	1490.0400	M5x16 / 5.00Nm	1492.0600	T 20	SCFT 12
1945.0365	SSSCL 25 25 12	25	25	150	25	32	25	l	1490.0400	M5x16 / 5.00Nm	1492.0600	T 20	SCFT 12

Tool will be delivered with holder, all screws and screw-driver, but without indexable inserts.



Rigid roughing tool with a strong insert for turning.



Indexable insert type K for a controlled chip or as chip-breaker.



The all purpose turning tool



Good cooling increases tool life.



Turning



Turning a shoulder



ALESA toolholder SS for turning

SCFT / 12 - 25

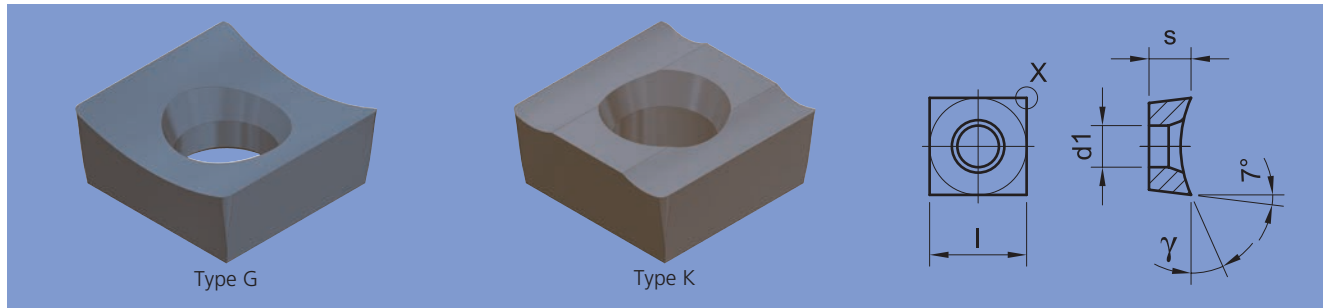

Turning

Cutting material	Coating	Part No	ISO Code	Type G/K	l mm	s mm	d1 mm	γ	Detail X		Werkstoffklassen					
											1	2	3	4	5	6
HSS-E	TiN	1591.0200	SCFT 09 04 04 FN	G	9.52	4	4.5	25°	R 0.4	r/l	○	○	●	○	●	
		1591.0220	SCFT 09 04 08 FN	G	9.52	4	4.5	25°	R 0.8	r/l	○	○	●	○	●	
		1591.0250	SCFT 12 05 AC FN	G	12.83	5.56	5.5	24°	0.2x45°	r/l	○	○	●	○	●	
		1591.0270	SCFT 12 05 04 FN	G	12.83	5.56	5.5	24°	R 0.4	r/l	○	○	●	○	●	
		1591.0290	SCFT 12 05 08 FN	G	12.83	5.56	5.5	24°	R 0.8	r/l	○	○	●	○	●	
		1591.0310	SCFT 12 05 12 FN	G	12.83	5.56	5.5	24°	R 1.2	r/l	○	○	●	○	●	
		1591.0700	SCFT 09 04 04 FN	K	9.52	4	4.5	30°	R 0.4	r/l	○	○	●	○	●	
		1591.0720	SCFT 09 04 08 FN	K	9.52	4	4.5	30°	R 0.8	r/l	○	○	●	○	●	
		1591.0770	SCFT 12 05 04 FN	K	12.83	5.56	5.5	30°	R 0.4	r/l	○	○	●	○	●	
		1591.0790	SCFT 12 05 08 FN	K	12.83	5.56	5.5	30°	R 0.8	r/l	○	○	●	○	●	
	TiAlN	1591.0810	SCFT 12 05 12 FN	K	12.83	5.56	5.5	30°	R 1.2	r/l	○	○	●	○	●	
		1666.0200	SCFT 09 04 04 FN	G	9.52	4	4.5	25°	R 0.4	r/l	○	●	●	○	●	
		1666.0220	SCFT 09 04 08 FN	G	9.52	4	4.5	25°	R 0.8	r/l	○	●	●	○	●	
		1666.0250	SCFT 12 05 AC FN	G	12.83	5.56	5.5	24°	0.2x45°	r/l	○	●	●	○	●	
		1666.0270	SCFT 12 05 04 FN	G	12.83	5.56	5.5	24°	R 0.4	r/l	○	●	●	○	●	
		1666.0290	SCFT 12 05 08 FN	G	12.83	5.56	5.5	24°	R 0.8	r/l	○	●	●	○	●	
		1666.0310	SCFT 12 05 12 FN	G	12.83	5.56	5.5	24°	R 1.2	r/l	○	●	●	○	●	
		1666.0700	SCFT 09 04 04 FN	K	9.52	4	4.5	30°	R 0.4	r/l	○	●	●	○	●	
		1666.0720	SCFT 09 04 08 FN	K	9.52	4	4.5	30°	R 0.8	r/l	○	●	●	○	●	
		1666.0770	SCFT 12 05 04 FN	K	12.83	5.56	5.5	30°	R 0.4	r/l	○	●	●	○	●	
1666.0790	SCFT 12 05 08 FN	K	12.83	5.56	5.5	30°	R 0.8	r/l	○	●	●	○	●			
1666.0810	SCFT 12 05 12 FN	K	12.83	5.56	5.5	30°	R 1.2	r/l	○	●	●	○	●			
Carbide MG20	TiAlN	1791.0255	SCFT 12 05 AC FN-111	G	12.83	5.56	5.5	24°	0.2x45°	r/l	●	○	●	●	○	●
		1791.0295	SCFT 12 05 08 FN-111	G	12.83	5.56	5.5	24°	R 0.8	r/l	●	○	●	●	○	●
	AlCrN	1791.0265	SCFT 12 05 AC FN-111	G	12.83	5.56	5.5	24°	0.2x45°	r/l	●	●	●	○	●	●
		1791.0305	SCFT 12 05 08 FN-111	G	12.83	5.56	5.5	24°	R 0.8	r/l	●	●	●	○	●	●
		1791.0325	SCFT 12 05 08 FN-121	G	12.83	5.56	5.5	14°	R 0.8	r/l	●	●	●	○	●	○

Overview of all indexable inserts see page 106 and following.

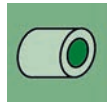

ALESA toolholder SC for turning inside

CCFT / 06 - 09

1917

Turning inside



1917.0280

Part No	Type	d1 mm	b1 mm	h mm	l1 mm	f mm	D min			Article	Type	Article	Type	WSP
1917.0190	A08H SCLCR 06	8	7.6	7.2	100	5	10	✓	r	1491.0210	M2.5x4 / 0.95Nm	1493.0300	TP7 IP	CCFT 06
1917.0195	A08H SCLCL 06	8	7.6	7.2	100	5	10	✓	l	1491.0210	M2.5x4 / 0.95Nm	1493.0300	TP7 IP	CCFT 06
1917.0200	A08H SCLCR 06	8	7.6	7.2	100	6	12	✓	r	1491.0210	M2.5x4 / 0.95Nm	1493.0300	TP7 IP	CCFT 06
1917.0205	A08H SCLCL 06	8	7.6	7.2	100	6	12	✓	l	1491.0210	M2.5x4 / 0.95Nm	1493.0300	TP7 IP	CCFT 06
1917.0220	A10K SCLCR 06	10	9.5	9	125	7	14	✓	r	1491.0220	M2.5x5 / 0.95Nm	1493.0300	TP7 IP	CCFT 06
1917.0225	A10K SCLCL 06	10	9.5	9	125	7	14	✓	l	1491.0220	M2.5x5 / 0.95Nm	1493.0300	TP7 IP	CCFT 06
1917.0240	A12L SCLCR 06	12	11.5	11	140	9	18	✓	r	1491.0220	M2.5x5 / 0.95Nm	1493.0300	TP7 IP	CCFT 06
1917.0245	A12L SCLCL 06	12	11.5	11	140	9	18	✓	l	1491.0220	M2.5x5 / 0.95Nm	1493.0300	TP7 IP	CCFT 06
1917.0260	A16Q SCLCR 09	16	15	14.5	180	11	22	✓	r	1490.0320	M4x8 / 3.85Nm	1492.0500	T 15	CCFT 09
1917.0265	A16Q SCLCL 09	16	15	14.5	180	11	22	✓	l	1490.0320	M4x8 / 3.85Nm	1492.0500	T 15	CCFT 09
1917.0280	A20R SCLCR 09	20	18.5	18	200	13	26	✓	r	1490.0340	M4x8 / 3.85Nm	1492.0500	T 15	CCFT 09
1917.0285	A20R SCLCL 09	20	18.5	18	200	13	26	✓	l	1490.0340	M4x8 / 3.85Nm	1492.0500	T 15	CCFT 09

Tool will be delivered with holder, all screws and screw-driver, but without indexable inserts.



The right execution of toolholders for boring need a left hand insert, and vice versa.



Holes for internal coolant supply guarantee ideal cooling.



Indexable insert type K for a controlled chip or as chip-breaker.



Good cooling increases tool life.



Boring

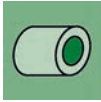

ALESA toolholder SC for turning inside

CCFT / 06 - 09

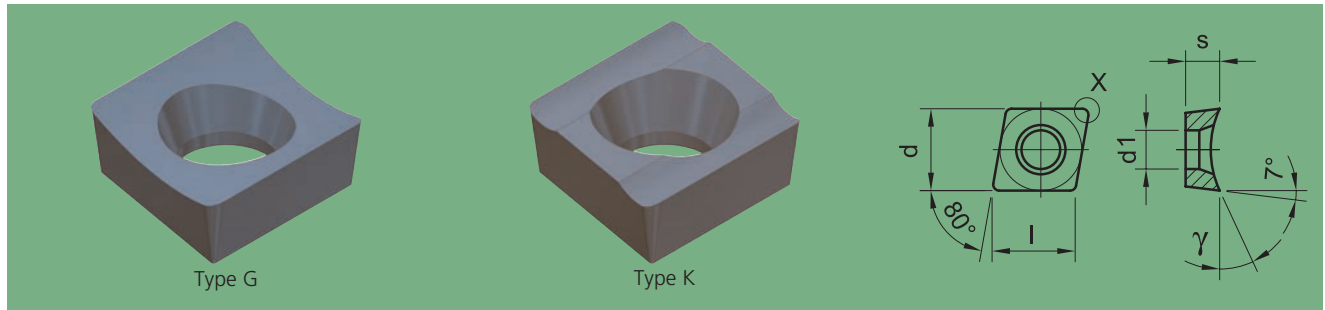

Turning inside

Cutting material	Coating	Part No	ISO Code	Type G/K	d mm	s mm	l mm	d1 mm	γ	Detail X	Detail X	Werkstoffklassen					
												1	2	3	4	5	6
HSS-E	TiN	1578.0245	CCFT 06 02 01 FR	G	6.35	2.38	6.4	3	20°	R 0.1	r	○	○	●	●	●	
		1578.0247	CCFT 06 02 01 FL	G	6.35	2.38	6.4	3	20°	R 0.1	l	○	○	●	●	●	
		1578.0250	CCFT 06 02 02 FR	G	6.35	2.38	6.4	3	20°	R 0.2	r	○	○	●	●	●	
		1578.0252	CCFT 06 02 02 FL	G	6.35	2.38	6.4	3	20°	R 0.2	l	○	○	●	●	●	
		1578.0255	CCFT 06 02 04 FR	G	6.35	2.38	6.4	3	20°	R 0.4	r	○	○	●	●	●	
		1578.0257	CCFT 06 02 04 FL	G	6.35	2.38	6.4	3	20°	R 0.4	l	○	○	●	●	●	
		1578.0350	CCFT 09 T3 02 FR	G	9.52	3.96	9.7	4.5	25°	R 0.2	r	○	○	●	●	●	
		1578.0352	CCFT 09 T3 02 FL	G	9.52	3.96	9.7	4.5	25°	R 0.2	l	○	○	●	●	●	
		1578.0355	CCFT 09 T3 04 FR	G	9.52	3.96	9.7	4.5	25°	R 0.4	r	○	○	●	●	●	
		1578.0357	CCFT 09 T3 04 FL	G	9.52	3.96	9.7	4.5	25°	R 0.4	l	○	○	●	●	●	
		1578.0360	CCFT 09 T3 08 FR	G	9.52	3.96	9.7	4.5	25°	R 0.8	r	○	○	●	●	●	
		1578.0362	CCFT 09 T3 08 FL	G	9.52	3.96	9.7	4.5	25°	R 0.8	l	○	○	●	●	●	
		1578.0750	CCFT 06 02 02 FR	K	6.35	2.38	6.4	3	30°	R 0.2	r	○	○	●	●	●	
		1578.0752	CCFT 06 02 02 FL	K	6.35	2.38	6.4	3	30°	R 0.2	l	○	○	●	●	●	
		1578.0755	CCFT 06 02 04 FR	K	6.35	2.38	6.4	3	30°	R 0.4	r	○	○	●	●	●	
		1578.0757	CCFT 06 02 04 FL	K	6.35	2.38	6.4	3	30°	R 0.4	l	○	○	●	●	●	
		1578.0855	CCFT 09 T3 04 FR	K	9.52	3.96	9.7	4.5	30°	R 0.4	r	○	○	●	●	●	
		1578.0857	CCFT 09 T3 04 FL	K	9.52	3.96	9.7	4.5	30°	R 0.4	l	○	○	●	●	●	
		1578.0860	CCFT 09 T3 08 FR	K	9.52	3.96	9.7	4.5	30°	R 0.8	r	○	○	●	●	●	
		1578.0862	CCFT 09 T3 08 FL	K	9.52	3.96	9.7	4.5	30°	R 0.8	l	○	○	●	●	●	
		TiAlN	1653.0245	CCFT 06 02 01 FR	G	6.35	2.38	6.4	3	20°	R 0.1	r	○	●	●	○	●
	1653.0247		CCFT 06 02 01 FL	G	6.35	2.38	6.4	3	20°	R 0.1	l	○	●	●	○	●	
	1653.0250		CCFT 06 02 02 FR	G	6.35	2.38	6.4	3	20°	R 0.2	r	○	●	●	○	●	
	1653.0252		CCFT 06 02 02 FL	G	6.35	2.38	6.4	3	20°	R 0.2	l	○	●	●	○	●	
	1653.0255		CCFT 06 02 04 FR	G	6.35	2.38	6.4	3	20°	R 0.4	r	○	●	●	○	●	
	1653.0257		CCFT 06 02 04 FL	G	6.35	2.38	6.4	3	20°	R 0.4	l	○	●	●	○	●	
	1653.0350		CCFT 09 T3 02 FR	G	9.52	3.96	9.7	4.5	25°	R 0.2	r	○	●	●	○	●	
	1653.0352		CCFT 09 T3 02 FL	G	9.52	3.96	9.7	4.5	25°	R 0.2	l	○	●	●	○	●	
	1653.0355		CCFT 09 T3 04 FR	G	9.52	3.96	9.7	4.5	25°	R 0.4	r	○	●	●	○	●	
	1653.0357		CCFT 09 T3 04 FL	G	9.52	3.96	9.7	4.5	25°	R 0.4	l	○	●	●	○	●	
	1653.0360		CCFT 09 T3 08 FR	G	9.52	3.96	9.7	4.5	25°	R 0.8	r	○	●	●	○	●	
	1653.0362		CCFT 09 T3 08 FL	G	9.52	3.96	9.7	4.5	25°	R 0.8	l	○	●	●	○	●	
	1653.0750		CCFT 06 02 02 FR	K	6.35	2.38	6.4	3	30°	R 0.2	r	○	●	●	○	●	
	1653.0752		CCFT 06 02 02 FL	K	6.35	2.38	6.4	3	30°	R 0.2	l	○	●	●	○	●	
	1653.0755		CCFT 06 02 04 FR	K	6.35	2.38	6.4	3	30°	R 0.4	r	○	●	●	○	●	
	1653.0757		CCFT 06 02 04 FL	K	6.35	2.38	6.4	3	30°	R 0.4	l	○	●	●	○	●	
	1653.0855		CCFT 09 T3 04 FR	K	9.52	3.96	9.7	4.5	30°	R 0.4	r	○	●	●	○	●	
	1653.0857		CCFT 09 T3 04 FL	K	9.52	3.96	9.7	4.5	30°	R 0.4	l	○	●	●	○	●	
	1653.0860		CCFT 09 T3 08 FR	K	9.52	3.96	9.7	4.5	30°	R 0.8	r	○	●	●	○	●	
	1653.0862		CCFT 09 T3 08 FL	K	9.52	3.96	9.7	4.5	30°	R 0.8	l	○	●	●	○	●	

Overview of all indexable inserts see page 106 and following.



ALESA toolholder SM for turning inside

MPFT 04 / 06 - 08

1918

Turning inside



1918.0200

Part No	Type	d1 mm	h mm	l1 mm	l2 mm	f mm	D min	↻	Article	Type	Article	Type	WSP
1918.0180	S06J SMFPR 04	6	5.5	90	15	3	6	r	1490.0190	M2x4 / 0.4Nm	1492.0200	T 6	MPFT 04
1918.0200	S08J SMFPR 04	8	7.2	100	20	4	8	r	1490.0190	M2x4 / 0.4Nm	1492.0200	T 6	MPFT 04

Tool will be delivered with holder, all screws and screw-driver, but without indexable inserts.



The right execution of toolholders for boring need a left hand insert, and vice versa.



The highly positive cutting geometries reduce the cutting forces considerably.



All ALESA indexable inserts are ground in the high ISO standard tolerance classification F.



Good cooling increases tool life.



Boring



ALESA toolholder SM for turning inside MPFT 04 / 06 - 08



Turning inside

Cutting material	Coating	Part No	ISO Code	Type G/K	γ	Detail X				Werkstoffklassen					
										1	2	3	4	5	6
HSS-E	TiN	1581.0210	MPFT 04 02 PP FL	G	18°	0.2x45°	I	●			○	○	●	○	●
	TiAlN	1656.0210	MPFT 04 02 PP FL	G	18°	0.2x45°	I	●			○	●	○	●	○

Overview of all indexable inserts see page 106 and following.

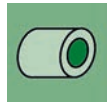

ALESA toolholder SD for turning inside

DCFT / 12 - 20

1927

Turning inside



1927.0340

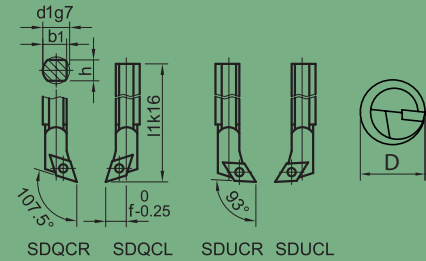

Part No	Type	d1 mm	b1 mm	h mm	l1 mm	f mm	D min			Article	Type	Article	Type	WSP
1927.0200	A12L SDQCR 07	12	11.5	11	140	9	18	✓	r	1491.0220	M2.5x5 / 0.95Nm	1493.0300	TP7 IP	DCFT 07
1927.0205	A12L SDQCL 07	12	11.5	11	140	9	18	✓	l	1491.0220	M2.5x5 / 0.95Nm	1493.0300	TP7 IP	DCFT 07
1927.0220	A16Q SDQCR 07	16	15	14.5	180	11	22	✓	r	1491.0220	M2.5x5 / 0.95Nm	1493.0300	TP7 IP	DCFT 07
1927.0225	A16Q SDQCL 07	16	15	14.5	180	11	22	✓	l	1491.0220	M2.5x5 / 0.95Nm	1493.0300	TP7 IP	DCFT 07
1927.0240	A20R SDQCR 11	20	18.5	18	200	13	26	✓	r	1490.0340	M4x8.5 / 3.85Nm	1492.0500	T 15	DCFT 11
1927.0245	A20R SDQCL 11	20	18.5	18	200	13	26	✓	l	1490.0340	M4x8.5 / 3.85Nm	1492.0500	T 15	DCFT 11
1927.0300	A12L SDUCR 07	12	11.5	11	140	9	18	✓	r	1491.0220	M2.5x5 / 0.95Nm	1493.0300	TP7 IP	DCFT 07
1927.0305	A12L SDUCL 07	12	11.5	11	140	9	18	✓	l	1491.0220	M2.5x5 / 0.95Nm	1493.0300	TP7 IP	DCFT 07
1927.0320	A16Q SDUCR 07	16	15	14.5	180	11	22	✓	r	1491.0220	M2.5x5 / 0.95Nm	1493.0300	TP7 IP	DCFT 07
1927.0325	A16Q SDUCL 07	16	15	14.5	180	11	22	✓	l	1491.0220	M2.5x5 / 0.95Nm	1493.0300	TP7 IP	DCFT 07
1927.0340	A20R SDUCR 11	20	18.5	18	200	13	26	✓	r	1490.0340	M4x8.5 / 3.85Nm	1492.0500	T 15	DCFT 11
1927.0345	A20R SDUCL 11	20	18.5	18	200	13	26	✓	l	1490.0340	M4x8.5 / 3.85Nm	1492.0500	T 15	DCFT 11

Tool will be delivered with holder, all screws and screw-driver, but without indexable inserts.



The right execution of toolholders for boring need a left hand insert, and vice versa.



Holes for internal coolant supply guarantee ideal cooling.



Indexable insert type K for a controlled chip or as chip-breaker.



Good cooling increases tool life.



Boring



ALESA toolholder SD for turning inside DCFT / 12 - 20

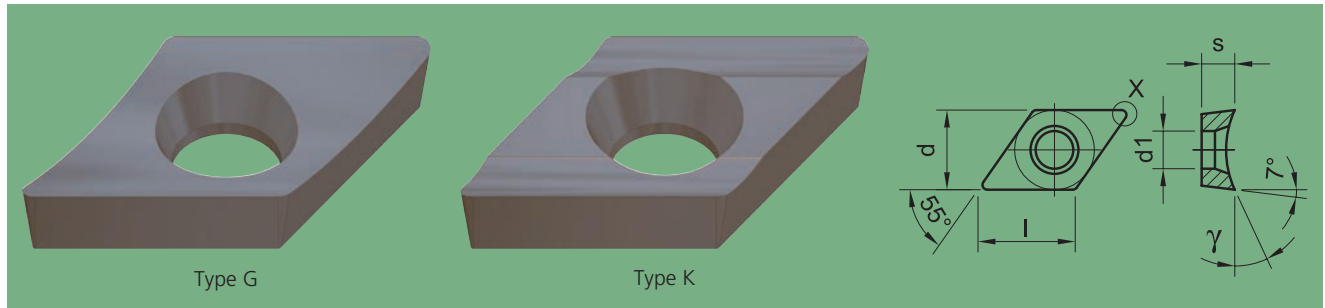

Turning inside

Cutting material	Coating	Part No	ISO Code	Type G/K	d mm	s mm	l mm	d1 mm	γ	Detail X	Detail X icon	Werkstoffklassen					
												1	2	3	4	5	6
HSS-E	TiN	1579.0245	DCFT 07 02 01 FR	G	6.35	2.38	7.75	3	20°	R 0.1	r	○	○		●	●	
		1579.0247	DCFT 07 02 01 FL	G	6.35	2.38	7.75	3	20°	R 0.1	l	○	○		●	●	
		1579.0250	DCFT 07 02 02 FR	G	6.35	2.38	7.75	3	20°	R 0.2	r	○	○		●	●	
		1579.0252	DCFT 07 02 02 FL	G	6.35	2.38	7.75	3	20°	R 0.2	l	○	○		●	●	
		1579.0255	DCFT 07 02 04 FR	G	6.35	2.38	7.75	3	20°	R 0.4	r	○	○		●	●	
		1579.0257	DCFT 07 02 04 FL	G	6.35	2.38	7.75	3	20°	R 0.4	l	○	○		●	●	
		1579.0355	DCFT 11 T3 04 FR	G	9.52	3.96	11.6	4.5	25°	R 0.4	r	○	○		●	●	
		1579.0357	DCFT 11 T3 04 FL	G	9.52	3.96	11.6	4.5	25°	R 0.4	l	○	○		●	●	
		1579.0360	DCFT 11 T3 08 FR	G	9.52	3.96	11.6	4.5	25°	R 0.8	r	○	○		●	●	
		1579.0362	DCFT 11 T3 08 FL	G	9.52	3.96	11.6	4.5	25°	R 0.8	l	○	○		●	●	
		1579.0750	DCFT 07 02 02 FR	K	6.35	2.38	7.75	3	30°	R 0.2	r	○	○		●	●	
		1579.0752	DCFT 07 02 02 FL	K	6.35	2.38	7.75	3	30°	R 0.2	l	○	○		●	●	
		1579.0755	DCFT 07 02 04 FR	K	6.35	2.38	7.75	3	30°	R 0.4	r	○	○		●	●	
		1579.0757	DCFT 07 02 04 FL	K	6.35	2.38	7.75	3	30°	R 0.4	l	○	○		●	●	
		1579.0855	DCFT 11 T3 04 FR	K	9.52	3.96	11.6	4.5	30°	R 0.4	r	○	○		●	●	
		1579.0857	DCFT 11 T3 04 FL	K	9.52	3.96	11.6	4.5	30°	R 0.4	l	○	○		●	●	
		1579.0860	DCFT 11 T3 08 FR	K	9.52	3.96	11.6	4.5	30°	R 0.8	r	○	○		●	●	
		1579.0862	DCFT 11 T3 08 FL	K	9.52	3.96	11.6	4.5	30°	R 0.8	l	○	○		●	●	
	TiAlN	1654.0245	DCFT 07 02 01 FR	G	6.35	2.38	7.75	3	20°	R 0.1	r	○	●		●	○	●
		1654.0247	DCFT 07 02 01 FL	G	6.35	2.38	7.75	3	20°	R 0.1	l	○	●		●	○	●
		1654.0250	DCFT 07 02 02 FR	G	6.35	2.38	7.75	3	20°	R 0.2	r	○	●		●	○	●
		1654.0252	DCFT 07 02 02 FL	G	6.35	2.38	7.75	3	20°	R 0.2	l	○	●		●	○	●
		1654.0255	DCFT 07 02 04 FR	G	6.35	2.38	7.75	3	20°	R 0.4	r	○	●		●	○	●
		1654.0257	DCFT 07 02 04 FL	G	6.35	2.38	7.75	3	20°	R 0.4	l	○	●		●	○	●
		1654.0355	DCFT 11 T3 04 FR	G	9.52	3.96	11.6	4.5	25°	R 0.4	r	○	●		●	○	●
		1654.0357	DCFT 11 T3 04 FL	G	9.52	3.96	11.6	4.5	25°	R 0.4	l	○	●		●	○	●
		1654.0360	DCFT 11 T3 08 FR	G	9.52	3.96	11.6	4.5	25°	R 0.8	r	○	●		●	○	●
		1654.0362	DCFT 11 T3 08 FL	G	9.52	3.96	11.6	4.5	25°	R 0.8	l	○	●		●	○	●
		1654.0750	DCFT 07 02 02 FR	K	6.35	2.38	7.75	3	30°	R 0.2	r	○	●		●	○	●
		1654.0752	DCFT 07 02 02 FL	K	6.35	2.38	7.75	3	30°	R 0.2	l	○	●		●	○	●
		1654.0755	DCFT 07 02 04 FR	K	6.35	2.38	7.75	3	30°	R 0.4	r	○	●		●	○	●
		1654.0757	DCFT 07 02 04 FL	K	6.35	2.38	7.75	3	30°	R 0.4	l	○	●		●	○	●
		1654.0855	DCFT 11 T3 04 FR	K	9.52	3.96	11.6	4.5	30°	R 0.4	r	○	●		●	○	●
		1654.0857	DCFT 11 T3 04 FL	K	9.52	3.96	11.6	4.5	30°	R 0.4	l	○	●		●	○	●
1654.0860	DCFT 11 T3 08 FR	K	9.52	3.96	11.6	4.5	30°	R 0.8	r	○	●		●	○	●		
1654.0862	DCFT 11 T3 08 FL	K	9.52	3.96	11.6	4.5	30°	R 0.8	l	○	●		●	○	●		

Overview of all indexable inserts see page 106 and following.



ALESA GOLD EXTRA toolbits round hardened and ground - ISO 5421 / 77

4120

Toolbits



Part No	d mm	L mm	
4120.0357	2	50	
4120.0361	2	100	
4120.0387	2.5	50	
4120.0391	2.5	100	
4120.0406	3	100	
4120.0421	3.5	100	
4120.0433	4	63	
4120.0436	4	100	
4120.0646	5	100	
4120.0676	6	100	
4120.0680	6	160	
4120.0695	7	160	
4120.0706	8	100	
4120.0710	8	160	
4120.0711	8	200	
4120.0736	10	100	
4120.0740	10	160	
4120.0741	10	200	
4120.0766	12	100	
4120.0771	12	200	
4120.0801	14	200	
4120.0831	16	200	
4120.0846	18	200	
4120.0861	20	200	
4120.0876	22	200	
4120.0891	25	200	
4120.0906	30	200	

Tolerance (d): h6

Hardness: 66 - 68 HRC



ALESA GOLD EXTRA toolbits square hardened and ground - ISO 5421 / 77

4140



Part No	b mm	b1 mm	L mm	
4140.0102	4	4	63	
4140.0122	5	5	63	
4140.0142	6	6	63	
4140.0145	6	6	100	
4140.0148	6	6	160	
4140.0149	6	6	200	
4140.0169	7	7	200	
4140.0182	8	8	63	
4140.0185	8	8	100	
4140.0188	8	8	160	
4140.0189	8	8	200	
4140.0222	10	10	63	
4140.0225	10	10	100	
4140.0228	10	10	160	
4140.0229	10	10	200	
4140.0265	12	12	100	
4140.0268	12	12	160	
4140.0269	12	12	200	
4140.0309	14	14	200	
4140.0349	16	16	200	
4140.0369	18	18	200	
4140.0389	20	20	200	
4140.0449	25	25	200	
4140.0529	32	32	200	

Tolerance (d): h13

Hardness: 66 - 68 HRC



ALESA GOLD EXTRA toolbits rectangular hardened and ground - ISO 5421 / 77

4160

Toolbits



Part No	h mm	b mm	L mm	
4160.0135	6	4	100	
4160.0165	8	2	100	
4160.0180	8	4	100	
4160.0210	10	3	100	
4160.0233	10	4	100	
4160.0240	10	5	100	
4160.0258	10	6	160	
4160.0259	10	6	200	
4160.0274	10	8	200	
4160.0285	12	3	100	
4160.0300	12	5	100	
4160.0318	12	6	160	
4160.0319	12	6	200	
4160.0334	12	8	200	
4160.0349	12	10	200	
4160.0364	14	6	200	
4160.0379	14	8	200	
4160.0454	15	10	200	
4160.0469	16	8	200	
4160.0484	16	10	200	
4160.0649	20	6	200	
4160.0679	20	10	200	
4160.0694	20	12	200	
4160.0709	20	15	200	
4160.0784	25	10	200	
4160.0799	25	12	200	
4160.0814	25	20	200	
4160.0889	32	20	200	

Tolerance (d): h13

Hardness: 66 - 68 HRc

Grooving and parting-off tools

Duocut



Duocut

12 - 25

No 4390

p. 94

Minicut



Minicut

10 - 20

No 4395

p. 96

Grooving and parting-off



KLH

20 - 25

No 1982

p. 98



KLS

20 - 25

No 1986

p. 100



Toolholder

10 - 100

No 1988

p. 102



Toolholder

25 - 60

No 4370

p. 104



ALESA toolholder Duocut and parting-off blades

4390

Duocut



4390.0500

Part No	h2 mm	b mm	h1 mm	l1 mm	l2 mm	Plate	Article	Type	Article	Type	WSP
4390.0200	12	10	9.8	80	10	4390.0220	4390.0230	M4x10	4390.0240	SW 2.5	4350 8 x 40
4390.0300	16	10	12.8	90	12	4390.0320	4390.0330	M4x12	4390.0240	SW 2.5	4350 10 x 44
4390.0400	20	12	15.8	110	14	4390.0420	4390.0430	M5x14	4390.0440	SW 3	4350 12 x 48
4390.0500	25	16	20.3	120	17	4390.0520	4390.0530	M6x16	4390.0540	SW 4	4350 16 x 54

Tool will be delivered with holder, screws and screw-driver, but without parting-off blades.





ALESA toolholder Duocut and parting-off blades



Duocut

Cutting material	Coating	Part No	H mm	l2 mm	s mm	D max mm					
HSS-E	TiN	4350.0210	8	40	0.5	18	N	●			
		4350.0220	8	40	0.7	18	N	●			
		4350.0230	8	40	0.8	18	N	●			
		4350.0240	8	40	0.9	18	N	●			
		4350.0250	8	40	1.1	18	N	●			
		4350.0260	8	40	1.3	18	N	●			
		4350.0270	8	40	1.6	18	N	●			
		4350.0272	8	40	1.6	18	18	r	●		
		4350.0274	8	40	1.6	18	18	l	●		
		4350.0280	8	40	1.85	18	18	N	●		
		4350.0310	10	44	0.5	22	22	N	●		
		4350.0320	10	44	0.7	22	22	N	●		
		4350.0330	10	44	0.8	22	22	N	●		
		4350.0340	10	44	0.9	22	22	N	●		
		4350.0350	10	44	1.1	22	22	N	●		
		4350.0360	10	44	1.3	22	22	N	●		
		4350.0370	10	44	1.6	22	22	N	●		
		4350.0372	10	44	1.6	22	22	22	r	●	
		4350.0374	10	44	1.6	22	22	22	l	●	
		4350.0380	10	44	1.85	22	22	N	●		
		4350.0420	12	48	1.1	26	26	N	●		
		4350.0430	12	48	1.3	26	26	N	●		
		4350.0440	12	48	1.6	26	26	N	●		
		4350.0442	12	48	1.6	26	26	26	r	●	
		4350.0444	12	48	1.6	26	26	26	l	●	
		4350.0450	12	48	1.85	26	26	N	●		
		4350.0460	12	48	2.15	26	26	N	●		
		4350.0462	12	48	2.15	26	26	26	r	●	
		4350.0464	12	48	2.15	26	26	26	l	●	
		4350.0470	12	48	2.65	26	26	N	●		
		4350.0520	16	54	1.6	32	32	N	●		
		4350.0522	16	54	1.6	32	32	32	r	●	
		4350.0524	16	54	1.6	32	32	32	l	●	
		4350.0530	16	54	1.85	32	32	N	●		
		4350.0540	16	54	2.15	32	32	N	●		
		4350.0550	16	54	3.15	32	32	N	●		
		4350.0552	16	54	3.15	32	32	32	r	●	
		4350.0554	16	54	3.15	32	32	32	l	●	
		4350.0560	16	54	4.15	32	32	N	●		



ALESA toolholder Minicut and parting-off blades

4395

Minicut



4395.0500

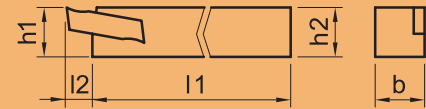

Part No	Type	h2 mm	b mm	h1 mm	l1 mm	l2 mm	Rollpin	Article	Type	Article	Type	WSP
4395.0400	Typ R	10	10	10	140	5	4395.0420	1490.0370	M4x9	1492.0600	T 20	4360 6 x 20
4395.0405	Typ L	10	10	10	140	5	4395.0420	1490.0370	M4x9	1492.0600	T 20	4360 6 x 20
4395.0500	Typ R	12	12	12	140	8	4395.0520	1490.0380	M4x11	1492.0600	T 20	4360 7 x 25
4395.0505	Typ L	12	12	12	140	8	4395.0520	1490.0380	M4x11	1492.0600	T 20	4360 7 x 25
4395.0530	Typ R	16	16	16	140	8	4395.0550	1490.0380	M4x11	1492.0600	T 20	4360 7 x 25
4395.0535	Typ L	16	16	16	140	8	4395.0550	1490.0380	M4x11	1492.0600	T 20	4360 7 x 25
4395.0560	Typ R	20	20	20	140	8	4395.0580	1490.0380	M4x11	1492.0600	T 20	4360 7 x 25
4395.0565	Typ L	20	20	20	140	8	4395.0580	1490.0380	M4x11	1492.0600	T 20	4360 7 x 25

Tool will be delivered with holder, screws and screw-driver, but without parting-off blades.

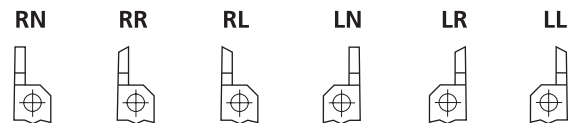

Info Exact positioning due to a perfect clamping device.

Info Correct center height and constant cutting speed for cutting off.

Info HSS-E is a shock-resistant cutting material ideal for interrupted cuts.

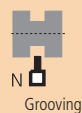



ALESA toolholder Minicut and parting-off blades



Minicut

Cutting material	Coating	Part No	H mm	l2 mm	s mm	D max mm			
HSS-E	TiN	4360.0410	6	20	0.5	10	RN	●	
		4360.0415	6	20	0.5	10	LN	●	
		4360.0430	6	20	0.8	10	RN	●	
		4360.0435	6	20	0.8	10	LN	●	
		4360.0450	6	20	1.1	10	RN	●	
		4360.0455	6	20	1.1	10	LN	●	
		4360.0550	7	25	1.1	16	RN	●	
		4360.0555	7	25	1.1	16	LN	●	
		4360.0560	7	25	1.3	16	RN	●	
		4360.0565	7	25	1.3	16	LN	●	
		4360.0570	7	25	1.6	16	RN	●	
		4360.0572	7	25	1.6	16	RR	●	
		4360.0574	7	25	1.6	16	RL	●	
		4360.0575	7	25	1.6	16	LN	●	
		4360.0577	7	25	1.6	16	LR	●	
4360.0579	7	25	1.6	16	LL	●			



ALESA grooving tools KLH and grooving inserts

1982

Grooving and parting-off



Part No	Type	h1 mm	h2 mm	b mm	s mm	l1 mm	H mm	D max mm	WSP
1982.0300	KLH 313 R	20	20	20	3.1	130	36	55	KLN/R/L 3
1982.0305	KLH 313 L	20	20	20	3.1	130	36	55	KLN/R/L 3
1982.0320	KLH 317 R	25	25	25	3.1	170	36	72	KLN/R/L 3
1982.0325	KLH 317 L	25	25	25	3.1	170	36	72	KLN/R/L 3

Tool will be delivered with holder, screws and screw-driver, but without grooving inserts.

Info Exact positioning due to a perfect clamping device.

Info Correct center height and constant cutting speed for cutting off.

Info HSS-E is a shock-resistant cutting material ideal for interrupted cuts.

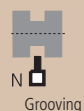



ALESA grooving tools KLH and grooving inserts



Grooving and parting-off

Cutting material	Coating	Part No	Type	s mm	H mm	l2 mm			
HSS-E	TiN	1598.0120	KLN 2	2.2	6.35	12	N	●	
		1598.0122	KLR 2	2.2	6.35	12	R	●	
		1598.0124	KLL 2	2.2	6.35	12	L	●	
		1598.0130	KLN 3	3.1	7.6	16	N	●	
		1598.0132	KLR 3	3.1	7.6	16	R	●	
		1598.0134	KLL 3	3.1	7.6	16	L	●	



ALESA grooving tools KLS and grooving inserts

1986

Grooving and parting-off



1986.0320

Part No	Type	h1 mm	h2 mm	b mm	s mm	l1 mm	H mm	D max mm	WSP
1986.0200	KLSH 210 R	10	10	10	2.2	110	24	30	KLN/R/L 2
1986.0205	KLSH 210 L	10	10	10	2.2	110	24	30	KLN/R/L 2
1986.0220	KLSH 212 R	12	12	10	2.2	110	24	44	KLN/R/L 2
1986.0225	KLSH 212 L	12	12	10	2.2	110	24	44	KLN/R/L 2
1986.0240	KLSH 216 R	16	16	10	2.2	110	24	44	KLN/R/L 2
1986.0245	KLSH 216 L	16	16	10	2.2	110	24	44	KLN/R/L 2
1986.0260	KLSH 220 R	20	20	10	2.2	110	24	44	KLN/R/L 2
1986.0265	KLSH 220 L	20	20	10	2.2	110	24	44	KLN/R/L 2
1986.0300	KLSH 312 R	12	12	10	3.1	110	28	44	KLN/R/L 3
1986.0305	KLSH 312 L	12	12	10	3.1	110	28	44	KLN/R/L 3
1986.0320	KLSH 316 R	16	16	10	3.1	110	28	44	KLN/R/L 3
1986.0325	KLSH 316 L	16	16	10	3.1	110	28	44	KLN/R/L 3
1986.0340	KLSH 320 R	20	20	10	3.1	110	28	44	KLN/R/L 3
1986.0345	KLSH 320 L	20	20	10	3.1	110	28	44	KLN/R/L 3

Tool will be delivered with holder, screws and screw-driver, but without grooving inserts.

Info Exact positioning due to a perfect clamping device.

Info Correct center height and constant cutting speed for cutting off.

Info HSS-E is a shock-resistant cutting material ideal for interrupted cuts.



R
Parting-off
right



L
Parting-off
left





N
Grooving



ALESA grooving tools KLS and grooving inserts



Grooving and parting-off

Cutting material	Coating	Part No	Type	s mm	H mm	l2 mm			
HSS-E	TiN	1598.0120	KLN 2	2.2	6.35	12	N	●	
		1598.0122	KLR 2	2.2	6.35	12	R	●	
		1598.0124	KLL 2	2.2	6.35	12	L	●	
		1598.0130	KLN 3	3.1	7.6	16	N	●	
		1598.0132	KLR 3	3.1	7.6	16	R	●	
		1598.0134	KLL 3	3.1	7.6	16	L	●	



ALESA toolholder for blades and grooving inserts

1988

Grooving and parting-off



Part No	Type	h1 mm	b mm	l1 mm	h mm	WSP
1988.0200	KLKH 25.26 R	25	20	120	32	KLK 311
1988.0205	KLKH 25.26 L	25	20	120	32	KLK 311

Info Exact positioning due to a perfect clamping device.

Info Correct center height and constant cutting speed for cutting off.

Info HSS-E is a shock-resistant cutting material ideal for interrupted cuts.

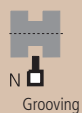



ALESA toolholder for blades and grooving inserts

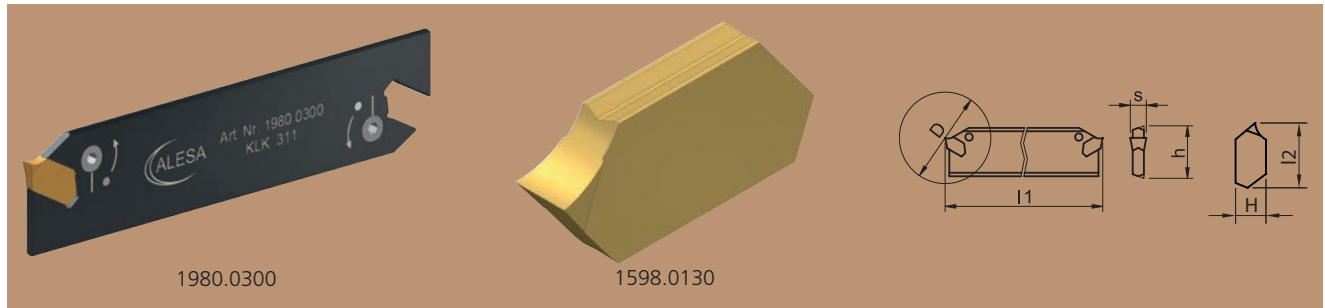

Grooving and parting-off

Part No	Type	s mm	h mm	H mm	I1 mm	I2 mm	D max mm			
1598.0130	KLN 3	3.1		7.6		16		N	●	
1598.0132	KLR 3	3.1		7.6		16		R	●	
1598.0134	KLL 3	3.1		7.6		16		L	●	
1980.0300	KLK 311	3.1	26		110		80			
1980.0320	KLK 315	3.1	32		150		100			



ALESA toolholder and trapezoidal blades

4370

Grooving and parting-off



Part No	L mm	S mm	H mm	B mm	WSP
4370.0300	70	13	16	10	10 x 2.5 x 1.9 mm
4370.0400	70	16	20	12	12 x 2.5 x 1.8 mm
4370.0500	90	20	25	16	16 x 3.0 x 2.0 mm
4370.0700	120	25	32	20	20 x 4.0 x 2.8 mm
4370.0800	150	32	40	25	25 x 4.8 x 3.3 mm







ALESA toolholder and trapezoidal blades

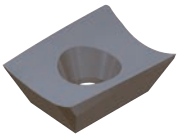
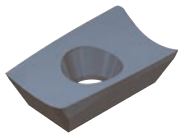
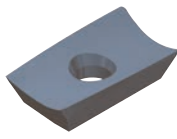
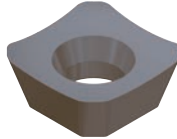

Grooving and parting-off

Part No	b mm	b1 mm	h mm	L mm
4310.0310	2.5	1.9	10	150
4310.0410	2.5	1.8	12	150
4310.0510	3	2	16	150
4310.0710	4	2.8	20	150
4310.0810	4.8	3.3	25	150
4310.0820	4.8	3.3	25	200

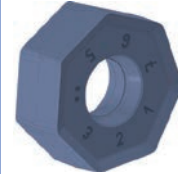
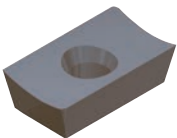
Indexable inserts

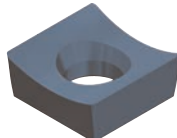
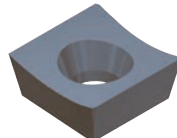
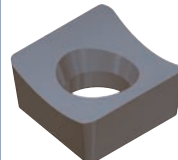
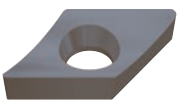
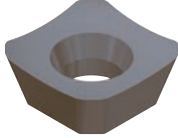
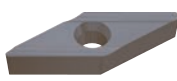
Indexable inserts					
					
TWIST AOFT 10	TWIST AOFT 15	TWIST AOFT 20	SDFT / SDHT	TNFU	XOFT
HSS & Carbide	HSS & Carbide	HSS & Carbide	HSS & Carbide	Carbide	Carbide
p. 107	p. 108	p. 109	p. 110	p. 111	p. 112
					
APFT / APHT	RPFT / RCFT	RPFT / RPHT	SCFT	MPFT	CCFT
HSS & Carbide	HSS	Carbide	HSS & Carbide	HSS & Carbide	HSS
Milling					
p. 113	p. 114	p. 115	p. 116	p. 117	p. 118
					
DCFT	SEFT	VCFT			
HSS	HSS & Carbide	HSS			
p. 119	p. 120	p. 121			



Indexable inserts TWIST AOFT 10 HSS and carbide



Cutting material	Coating	Part No	ISO Code	d mm	s mm	l mm	d1 mm	Detail X			
HSS-E	TiN	1087.0170	AOFT 10 03 PF FR	7	3.4	9.5	2.8	0.2x45°	r	●	○
		1087.0180	AOFT 10 03 04 FR	7	3.4	9.5	2.8	R 0.4	r	●	○
	TiAlN	1162.0170	AOFT 10 03 PF FR	7	3.4	9.5	2.8	0.2x45°	r	●	○
		1162.0180	AOFT 10 03 04 FR	7	3.4	9.5	2.8	R 0.4	r	●	○
Carbide HM	TiN	1287.0200	AOFT 10 03 PF FR-411	7	3.4	9.5	2.8	0.2x45°	r	●	○
		1287.0205	AOFT 10 03 04 FR-411	7	3.4	9.5	2.8	R 0.4	r	●	○
	TiAlN	1287.0300	AOFT 10 03 PF FR-411	7	3.4	9.5	2.8	0.2x45°	r	●	○
		1287.0305	AOFT 10 03 04 FR-411	7	3.4	9.5	2.8	R 0.4	r	●	○
	AlCrN	1287.0651	AOFT 10 03 PF FR-421	7	3.4	9.5	2.8	0.2x45°	r	●	○
		1287.0656	AOFT 10 03 04 FR-421	7	3.4	9.5	2.8	R 0.4	r	●	○
		1287.0657	AOFT 10 03 04 FR-431	7	3.4	9.5	2.8	R 0.4	r	●	○
		1288.0300	AOFT 10 03 ZZ FR-481	7	3.35		2.8		r	●	○
AlCrN-VA	1287.0757	AOFT 10 03 04 FR-431	7	3.4	9.5	2.8	R 0.4	r	●	○	
Carbide HM-F	AlCrN	1287.0701	AOFT 10 03 PF FR-521	7	3.4	9.5	2.8	0.2x45°	r		●
		1287.0706	AOFT 10 03 04 FR-521	7	3.4	9.5	2.8	R 0.4	r		●
		1287.0707	AOFT 10 03 04 FR-531	7	3.4	9.5	2.8	R 0.4	r		●
		1288.0500*	AOFT 10 03 ZZ FR-581	7	3.35		2.8		r		●
	AlCrN-VA	1287.0807	AOFT 10 03 04 FR-531	7	3.4	9.5	2.8	R 0.4	r		●
Carbide HA	AlCrN-VA	1289.0202	AOFT 10 03 04 FR-631	7	3.4	9.5	2.8	R 0.4	r	●	○
	TiNox	1288.0700	AOFT 10 03 ZZ FR-681	7	3.35		2.8		r	●	○

*while stocks last



Indexable inserts TWIST AOFT 15

HSS and carbide

Indexable inserts

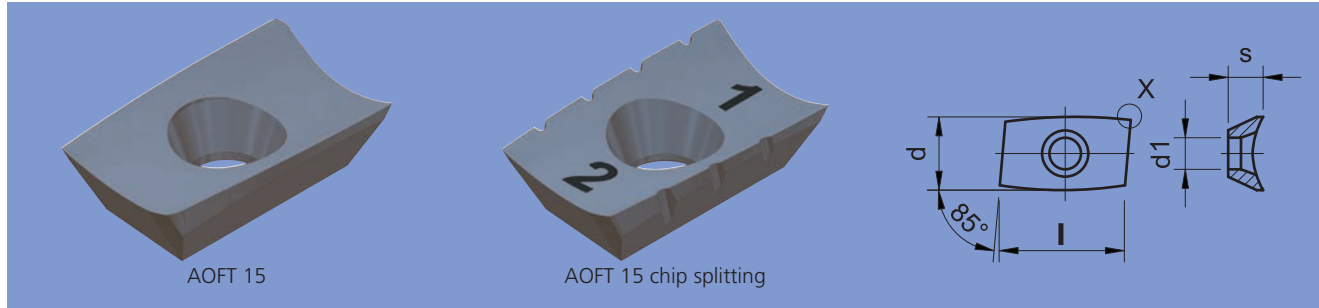



Cutting material	Coating	Part No	ISO Code	d mm	s mm	l mm	d1 mm	Detail X			
HSS-E	TiN	1087.0190	AOFT 15 T3 PF FR	8.8	4.2	14.5	3.8	0.2x45°	r	●	
		1087.0210	AOFT 15 T3 08 FR	8.8	4.2	14.5	3.8	R 0.8	r	●	
	TiAlN	1162.0190	AOFT 15 T3 PF FR	8.8	4.2	14.5	3.8	0.2x45°	r	●	
		1162.0210	AOFT 15 T3 08 FR	8.8	4.2	14.5	3.8	R 0.8	r	●	
HSS-E chip splitting °)	TiN	1087.0505	AOFT 15 T3 PF FR (No 1/2)	8.8	4.2	14.5	3.8	0.2x45°	r	●	
		1087.0508	AOFT 15 T3 PF FR (No 3)	8.8	4.2	14.5	3.8	0.2x45°	r	●	
Carbide HM	TiN	1287.0210	AOFT 15 T3 PF FR-411	8.8	4.2	14.5	3.8	0.2x45°	r	●	○
		1287.0215	AOFT 15 T3 08 FR-411	8.8	4.2	14.5	3.8	R 0.8	r	●	○
	TiAlN	1287.0310	AOFT 15 T3 PF FR-411	8.8	4.2	14.5	3.8	0.2x45°	r	●	○
		1287.0315	AOFT 15 T3 08 FR-411	8.8	4.2	14.5	3.8	R 0.8	r	●	○
	AlCrN	1287.0661	AOFT 15 T3 PF FR-421	8.8	4.2	14.5	3.8	0.2x45°	r	●	○
		1287.0666	AOFT 15 T3 08 FR-421	8.8	4.2	14.5	3.8	R 0.8	r	●	○
		1287.0667	AOFT 15 T3 08 FR-431	8.8	4.2	14.5	3.8	R 0.8	r	●	○
		1287.0669	AOFT 15 T3 12 FR-421	8.8	4.2	14.5	3.8	R 1.2	r	●	○
		1287.0671	AOFT 15 T3 16 FR-421	8.8	4.2	14.5	3.8	R 1.6	r	●	○
		1287.0673	AOFT 15 T3 20 FR-421	8.8	4.2	14.5	3.8	R 2.0	r	●	○
	AlCrN-VA DLC-H	1287.0767	AOFT 15 T3 08 FR-431	8.8	4.2	14.5	3.8	R 0.8	r	●	○
		1287.0916	AOFT 15 T3 08 FR-421	8.8	4.2	14.5	3.8	R 0.8	r	●	○
Carbide HM-F	TiAlN	1287.0510	AOFT 15 T3 PF FR-511	8.8	4.2	14.5	3.8	0.2x45°	r		●
		1287.0515	AOFT 15 T3 08 FR-511	8.8	4.2	14.5	3.8	R 0.8	r		●
	AlCrN	1287.0711	AOFT 15 T3 PF FR-521	8.8	4.2	14.5	3.8	0.2x45°	r		●
		1287.0716	AOFT 15 T3 08 FR-521	8.8	4.2	14.5	3.8	R 0.8	r		●
		1287.0717	AOFT 15 T3 08 FR-531	8.8	4.2	14.5	3.8	R 0.8	r		●
		1287.0718	AOFT 15 T3 08 FR-521/40	8.8	4.2	14.5	3.8	R 0.8	r	○	●
		1287.0719	AOFT 15 T3 08 FR-521/50/63	8.8	4.2	14.5	3.8	R 0.8	r	○	●
		1287.0720	AOFT 15 T3 08 FR-521/80-125	8.8	4.2	14.5	3.8	R 0.8	r	○	●
	AlCrN-VA DLC-H	1287.0817	AOFT 15 T3 08 FR-531	8.8	4.2	14.5	3.8	R 0.8	r		●
		1287.0967	AOFT 15 T3 08 FR-531	8.8	4.2	14.5	3.8	R 0.8	r		●
Carbide HA	AlCrN-VA	1289.0232	AOFT 15 T3 08 FR-631	8.8	4.2	14.5	3.8	R 0.8	r	●	○

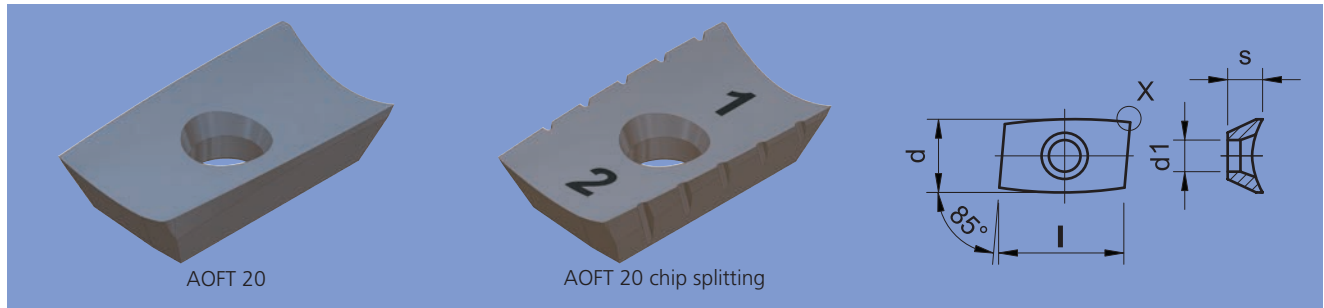

Indexable inserts TWIST AOFT 20 HSS and carbide



Cutting material	Coating	Part No	ISO Code	d mm	s mm	l mm	d1 mm	Detail X			
HSS-E	TiN	1087.0215	AOFT 20 04 PF FR	11	4.76	19.4	4.5	0.2x45°	r	●	
		1087.0315	AOFT 20 04 08 FR	11	4.76	19.4	4.5	R 0.8	r	●	
	TiAlN	1162.0215	AOFT 20 04 PF FR	11	4.76	19.4	4.5	0.2x45°	r	●	
		1162.0315	AOFT 20 04 08 FR	11	4.76	19.4	4.5	R 0.8	r	●	
HSS-E chip splitting °)	TiN	1087.0515	AOFT 20 04 PF FR (No 1/2)	11	4.76	19.4	4.5	0.2x45°	r	●	
		1087.0518	AOFT 20 04 PF FR (No 3)	11	4.76	19.4	4.5	0.2x45°	r	●	
Carbide HM	TiN	1287.0225	AOFT 20 04 PF FR-411	11	4.76	19.4	4.5	0.2x45°	r	●	○
		1287.0230	AOFT 20 04 08 FR-411	11	4.76	19.4	4.5	R 0.8	r	●	○
	TiAlN	1287.0325	AOFT 20 04 PF FR-411	11	4.76	19.4	4.5	0.2x45°	r	●	○
		1287.0330	AOFT 20 04 08 FR-411	11	4.76	19.4	4.5	R 0.8	r	●	○
	AlCrN	1287.0676	AOFT 20 04 PF FR-421	11	4.76	19.4	4.5	0.2x45°	r	●	○
		1287.0681	AOFT 20 04 08 FR-421	11	4.76	19.4	4.5	R 0.8	r	●	○
	AlCrN-VA	1287.0682	AOFT 20 04 08 FR-431	11	4.76	19.4	4.5	R 0.8	r	●	○
Carbide HM-F	TiAlN	1287.0525	AOFT 20 04 PF FR-511	11	4.76	19.4	4.5	0.2x45°	r		●
		1287.0530	AOFT 20 04 08 FR-511	11	4.76	19.4	4.5	R 0.8	r		●
	AlCrN	1287.0726	AOFT 20 04 PF FR-521	11	4.76	19.4	4.5	0.2x45°	r		●
		1287.0731	AOFT 20 04 08 FR-521	11	4.76	19.4	4.5	R 0.8	r		●
	AlCrN-VA	1287.0735	AOFT 20 04 08 FR-531	11	4.76	19.4	4.5	R 0.8	r		●
		1287.0835	AOFT 20 04 08 FR-531	11	4.76	19.4	4.5	R 0.8	r		●
Carbide HA	AlCrN-VA	1289.0262	AOFT 20 04 08 FR-631	11	4.76	19.4	4.5	R 0.8	r	●	○



Indexable inserts SDFT / SDHT HSS and carbide

Indexable inserts

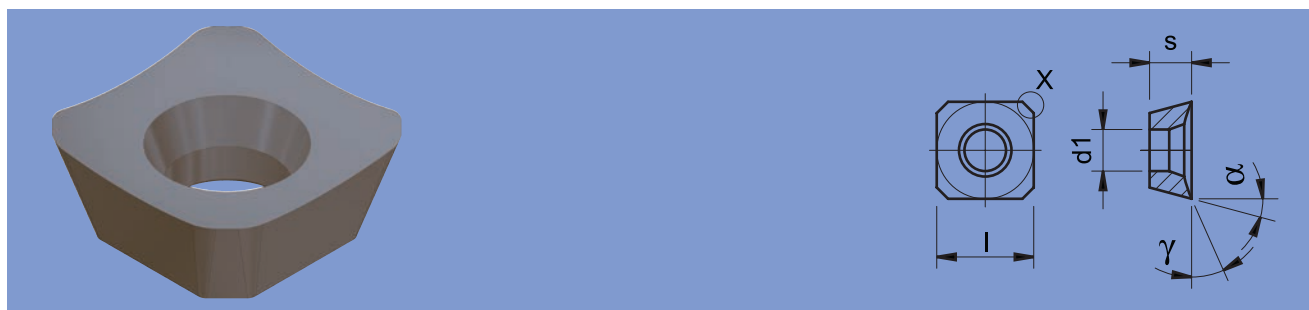

Cutting material	Coating	Part No	ISO Code	l mm	s mm	d1 mm	α	γ	Detail X			
HSS-E	TiN	1091.0400	SDFT 09 T3 AE FN	9.52	3.97	4.5	15°	17°	1.2x45° R1.2	r/l	●	
		1091.0450	SDFT 12 04 AE FN	12.7	4.76	5.5	15°	17°	1.5x45° R2	r/l	●	
	TiAlN	1166.0400	SDFT 09 T3 AE FN	9.52	3.97	4.5	15°	17°	1.2x45° R1.2	r/l	●	
		1166.0450	SDFT 12 04 AE FN	12.7	4.76	5.5	15°	17°	1.5x45° R2	r/l	●	
Carbide MG20	TiN	1291.0400	SDFT 09 T3 AE FN-111	9.52	3.97	4.5	15°	17°	1.2x45° R1.2	r/l	○	●
		1291.0450	SDFT 12 04 AE FN-111	12.7	4.76	5.5	15°	17°	1.5x45° R2	r/l	○	●
	TiAlN	1291.0405	SDFT 09 T3 AE FN-111	9.52	3.97	4.5	15°	17°	1.2x45° R1.2	r/l	○	●
		1291.0455	SDFT 12 04 AE FN-111	12.7	4.76	5.5	15°	17°	1.5x45° R2	r/l	○	●
	AlCrN	1291.0415	SDFT 09 T3 AE FN-111	9.52	3.97	4.5	15°	17°	1.2x45° R1.2	r/l	○	●
1291.0465		SDFT 12 04 AE FN-111	12.7	4.76	5.5	15°	17°	1.5x45° R2	r/l	○	●	
Carbide 12CR	TiAlN	1291.0420*	SDHT 09 T3 AE FN-222	9.52	3.97	4.5	15°	11°	1.2x45° R1.2	r/l	○	●
		1291.0470*	SDHT 12 04 AE FN-222	12.7	4.76	5.5	15°	11°	1.5x45° R2	r/l	○	●
	AlCrN	1291.0430*	SDHT 09 T3 AE FN-222	9.52	3.97	4.5	15°	11°	1.2x45° R1.2	r/l	○	●
		1291.0480*	SDHT 12 04 AE FN-222	12.7	4.76	5.5	15°	11°	1.5x45° R2	r/l	○	●
	AlCrN-VA	1291.0630*	SDFT 09 T3 AE FN-223	9.52	3.97	4.5	15°	5°	1.2x45° R1.2	r/l	○	●
		1291.0680*	SDFT 12 04 AE FN-223	12.7	4.76	5.5	15°	5°	1.5x45° R2	r/l	○	●
	DLC-H	1291.0635*	SDFT 09 T3 AE FN-223	9.52	3.97	4.5	15°	5°	1.2x45° R1.2	r/l	○	●
		1291.0685*	SDFT 12 04 AE FN-223	12.7	4.76	5.5	15°	5°	1.5x45° R2	r/l	○	●
		1291.0720*	SDFT 09 T3 AE FR-223-S	9.52	3.97	4.5	15°	5°	1.2x45° R1.2	r	○	●
		1291.0770*	SDFT 12 04 AE FR-223-S	12.7	4.76	5.5	15°	5°	1.5x45° R2	r	○	●
Ceramic CTS-X	TiNox	1291.0640*	SDFT 09 T3 AE FN-223	9.52	3.97	4.5	15°	5°	1.2x45° R1.2	r/l	●	○
		1291.0690*	SDFT 12 04 AE FN-223	12.7	4.76	5.5	15°	5°	1.5x45° R2	r/l	●	○
		1291.0320	SDHT 09 T3 AE FN-722	9.52	3.97	4.4	15°	11°	1.2x45° R1.2	r/l	●	○
		1291.0370	SDHT 12 04 AE FN-722	12.7	4.76	5.5	15°	11°	1.5x45° R2	r/l	●	○
Ceramic KG14	AlCrN-K	1291.0520	SDFT 09 T3 AE FN-723	9.52	3.97	4.4	15°	5°	1.2x45° R1.2	r/l	●	○
		1291.0570	SDFT 12 04 AE FN-723	12.7	4.76	5.5	15°	5°	1.5x45° R2	r/l	●	○
Ceramic KG14	AlCrN-K	1292.0200*	SDFT 09 T3 AE FN-851	9.52	3.97	4.4	15°	0°	1.2x45° R1.2	r/l		●
		1292.0225*	SDFT 12 04 AE FN-851	12.7	4.76	5.5	15°	0°	1.5x45° R2	r/l		●

*while stocks last



Indexable inserts DELTA TNFU Carbide

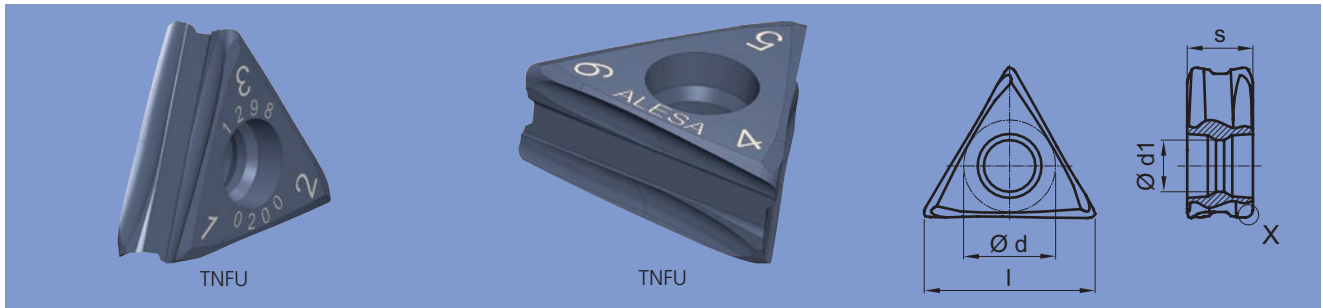

Cutting material	Coating	Part No	ISO Code	l mm	s mm	d mm	d1 mm	Detail X			
Carbide CTS	AlCrN-VA	1297.0200	TNFU 11 S4 04 FR-321	11.2	4.2	6	3.4	R 0.4	r	●	○
		1297.0650	TNFU 11 S4 PF FR-321	11.2	4.2	6	3.4	0.2x45°	r	●	○
		1298.0200	TNFU 18 07 08 FR-321	18.3	7	9.8	5.5	R 0.8	r	●	○
		1298.0650	TNFU 18 07 PF FR-321	18.3	7	9.8	5.5	0.2x45°	r	●	○
	DLC-H	1297.0201	TNFU 11 S4 04 FR-321	11.2	4.2	6	3.4	R 0.4	r	●	○
		1297.0651	TNFU 11 S4 PF FR-321	11.2	4.2	6	3.4	0.2x45°	r	●	○
		1298.0201	TNFU 18 07 08 FR-321	18.3	7	9.8	5.5	R 0.8	r	●	○
		1298.0651	TNFU 18 07 PF FR-321	18.3	7	9.8	5.5	0.2x45°	r	●	○
Carbide CTS-X	TiNox	1297.0267	TNFU 11 S4 04 FR-731	11.2	4.2	6	3.4	R 0.4	r	●	○
		1297.0717	TNFU 11 S4 PF FR-731	11.2	4.2	6	3.4	0.2x45°	r	●	○
		1298.0267	TNFU 18 07 08 FR-731	18.3	7	9.8	5.5	R 0.8	r	●	○
		1298.0717	TNFU 18 07 PF FR-731	18.3	7	9.8	5.5	0.2x45°	r	●	○
Carbide CTM	TiNox	1297.0317	TNFU 11 S4 04 FR-931	11.2	4.2	6	3.4	R 0.4	r	●	○
		1298.0317	TNFU 18 07 08 FR-931	18.3	7	9.8	5.5	R 0.8	r	●	○
Carbide CTS-G	TiNox-G	1298.0318	TNFU 18 07 08 FR-031	18.3	7	9.8	5.5	R 0.8	r	●	○



Indexable inserts HEPTA XOFT Carbide

Indexable inserts

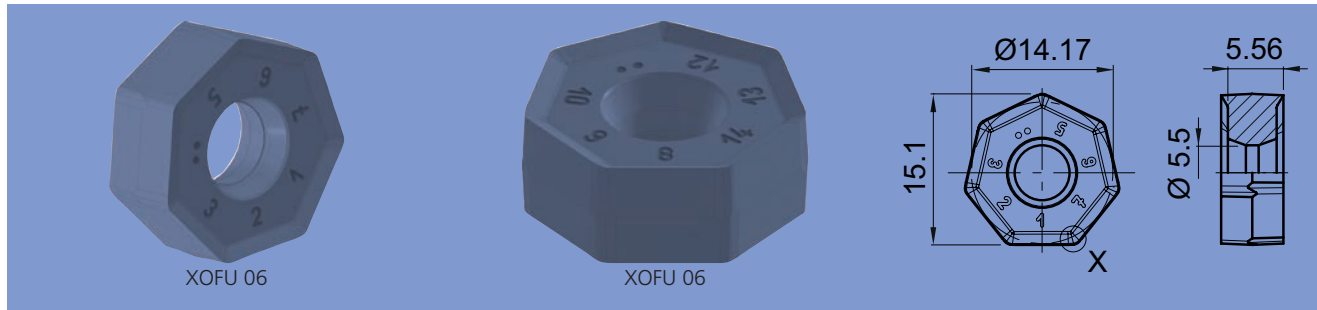

Cutting material	Coating	Part No	ISO Code	Detail X			
Carbide CTS	AlCrN-VA	1279.0200	XOFU 06 05 08 FR-322	R 0.8	r	●	○
Carbide CTS-X	TiNox	1279.0267	XOFU 06 05 08 FR-732	R 0.8	r	●	○
Carbide CTM	TiNox	1279.0317	XOFU 06 05 08 FR-932	R 0.8	r	●	○



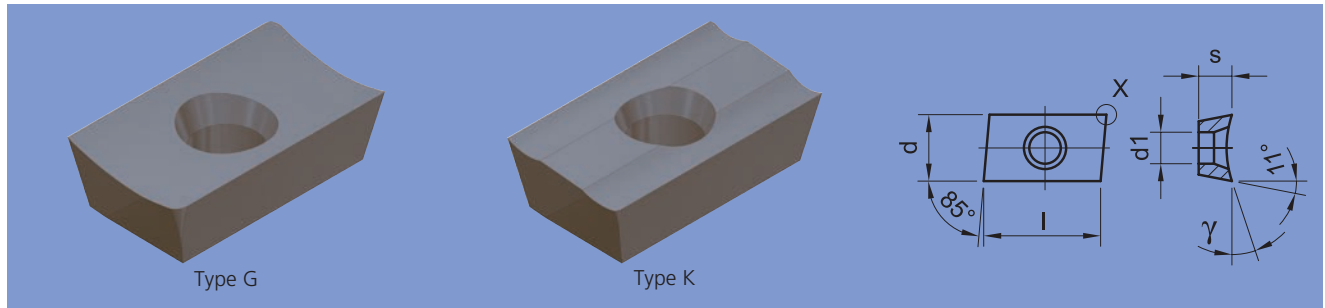

Indexable inserts APFT / APHT

HSS and carbide



Indexable inserts

Cutting material	Coating	Part No	ISO Code	Type G/K	d mm	s mm	l mm	d1 mm	γ	Detail X				
HSS-E	TiN	1085.0200	APFT 16 04 PD FR	G	9.52	4.76	16.7	4.5	18°	0.2x45°	r	●		
		1085.0210	APFT 16 04 PD FL	G	9.52	4.76	16.7	4.5	18°	0.2x45°	l	●		
		1085.0230	APFT 16 04 PD FR	G	9.52	4.76	16.7	4.5	25°	0.2x45°	r	●		
		1085.0250	APFT 16 04 04 FR	G	9.52	4.76	16.7	4.5	18°	R 0.4	r	●		
		1085.0260	APFT 16 04 04 FL	G	9.52	4.76	16.7	4.5	18°	R 0.4	l	●		
		1085.0300	APFT 16 04 08 FR	G	9.52	4.76	16.7	4.5	18°	R 0.8	r	●		
		1085.0310	APFT 16 04 08 FL	G	9.52	4.76	16.7	4.5	18°	R 0.8	l	●		
		1085.0350	APFT 16 04 12 FR	G	9.52	4.76	16.7	4.5	18°	R 1.2	r	●		
		1085.0360	APFT 16 04 12 FL	G	9.52	4.76	16.7	4.5	18°	R 1.2	l	●		
		1585.0700	APFT 16 04 PD FR	K	9.52	4.76	16.7	4.5	26°	0.2x45°	r	●		
		1585.0750	APFT 16 04 04 FR	K	9.52	4.76	16.7	4.5	26°	R 0.4	r	●		
		1160.0200	APFT 16 04 PD FR	G	9.52	4.76	16.7	4.5	18°	0.2x45°	r	●		
		1160.0230	APFT 16 04 PD FR	G	9.52	4.76	16.7	4.5	25°	0.2x45°	r	●		
		1160.0250	APFT 16 04 04 FR	G	9.52	4.76	16.7	4.5	18°	R 0.4	r	●		
		Carbide MG20	TiN	1285.0200	APFT 16 04 PD FR-111	G	9.52	4.76	16.7	4.5	18°	0.2x45°	r	○
1285.0250	APFT 16 04 04 FR-111			G	9.52	4.76	16.7	4.5	18°	R 0.4	r	○	●	
1285.0300	APFT 16 04 08 FR-111			G	9.52	4.76	16.7	4.5	18°	R 0.8	r	○	●	
TiAlN	1285.0205*		APFT 16 04 PD FR-111	G	9.52	4.76	16.7	4.5	18°	0.2x45°	r	○	●	
	1285.0255*		APFT 16 04 04 FR-111	G	9.52	4.76	16.7	4.5	18°	R 0.4	r	○	●	
	1285.0305*		APFT 16 04 08 FR-111	G	9.52	4.76	16.7	4.5	18°	R 0.8	r	○	●	
AlCrN	1285.0215		APFT 16 04 PD FR-111	G	9.52	4.76	16.7	4.5	18°	0.2x45°	r	○	●	
	1285.0265		APFT 16 04 04 FR-111	G	9.52	4.76	16.7	4.5	18°	R 0.4	r	○	●	
	1285.0315		APFT 16 04 08 FR-111	G	9.52	4.76	16.7	4.5	18°	R 0.8	r	○	●	
AlCrN-VA	1285.0515*		APFT 16 04 PD FR-121	G	9.52	4.76	16.7	4.5	10°	0.2x45°	r	○	●	
	1285.0615*		APFT 16 04 08 FR-121	G	9.52	4.76	16.7	4.5	10°	R 0.8	r	○	●	
	1285.0520*		APFT 16 04 PD FR-121	G	9.52	4.76	16.7	4.5	10°	0.2x45°	r	○	●	
Carbide 12CR	TiAlN		1285.0620	APFT 16 04 08 FR-121	G	9.52	4.76	16.7	4.5	10°	R 0.8	r	○	●
			1285.0400*	APHT 16 04 PD FR-222	G	9.52	4.76	16.7	4.5	16°		r	●	●
	AlCrN		1285.0410*	APHT 16 04 PD FR-222	G	9.52	4.76	16.7	4.5	16°		r	●	●

*while stocks last



Indexable inserts RPFT / RCFT HSS

Indexable inserts

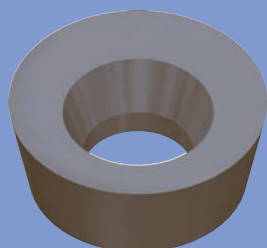

RPFT 08

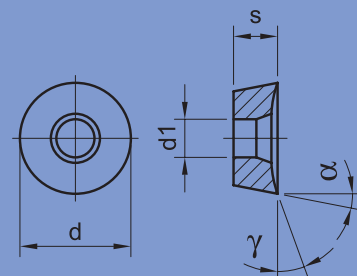

Cutting material	Coating	Part No	ISO Code	d mm	s mm	d1 mm	α	γ			
HSS-E	TiN	1076.0200	RPFT 06 02 M0	6	2.38	3	11°	20°	r/l	●	
		1076.0240	RPFT 08 03 M0	8	3.18	3.6	11°	20°	r/l	●	
		1076.0300	RPFT 10 T3 M0	10	3.97	4.5	11°	20°	r/l	●	
		1076.0400	RPFT 12 04 M0	12	4.76	5.5	11°	20°	r/l	●	
		1076.0410	RPFT 12 04 M0	12	4.76	5.5	11°	30°	r/l	●	
		1076.0450	RPFT 12 04 00	12.7	4.76	5.5	11°	20°	r/l	●	
		1576.0200	RCFT 06 02 M0	6	2.38	3	7°	25°	r/l	●	
		1576.0240	RCFT 08 03 M0	8	3.18	3.6	7°	25°	r/l	●	
		1576.0250	RCFT 08 03 M0	8	3.18	4.5	7°	25°	r/l	●	
		1576.0300	RCFT 10 T3 M0	10	3.97	4.5	7°	25°	r/l	●	
		1576.0400	RCFT 12 04 M0	12	4.76	5.5	7°	25°	r/l	●	
		1576.0500	RCFT 16 06 M0	16	6.35	5.5	7°	25°	r/l	●	
	TiAlN	1576.0600	RCFT 20 06 M0	20	6.35	6.5	7°	25°	r/l	●	
		1151.0200	RPFT 06 02 M0	6	2.38	3	11°	20°	r/l	●	
		1151.0240	RPFT 08 03 M0	8	3.18	3.6	11°	20°	r/l	●	
		1151.0300	RPFT 10 T3 M0	10	3.97	4.5	11°	20°	r/l	●	
		1151.0400	RPFT 12 04 M0	12	4.76	5.5	11°	20°	r/l	●	
		1151.0410	RPFT 12 04 M0	12	4.76	5.5	11°	30°	r/l	●	
		1151.0450	RPFT 12 04 00	12.7	4.76	5.5	11°	20°	r/l	●	
		1651.0200	RCFT 06 02 M0	6	2.38	3	7°	25°	r/l	●	
		1651.0240	RCFT 08 03 M0	8	3.18	3.6	7°	25°	r/l	●	
		1651.0250	RCFT 08 03 M0	8	3.18	4.5	7°	25°	r/l	●	
		1651.0300	RCFT 10 T3 M0	10	3.97	4.5	7°	25°	r/l	●	
		1651.0400	RCFT 12 04 M0	12	4.76	5.5	7°	25°	r/l	●	
		1651.0500	RCFT 16 06 M0	16	6.35	5.5	7°	25°	r/l	●	
		1651.0600	RCFT 20 06 M0	20	6.35	6.5	7°	25°	r/l	●	



Indexable inserts RPFT / RPHT

Carbide

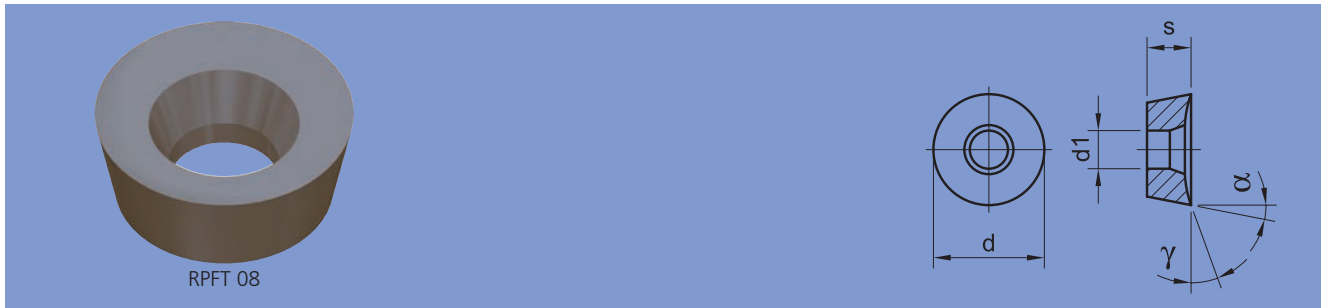

Cutting material	Coating	Part No	ISO Code	d mm	s mm	d1 mm	α	γ			
Carbide MG20	TiN	1276.0200	RPFT 06 02 M0-111	6	2.38	3	11°	20°	r/l	○	●
		1276.0240	RPFT 08 03 M0-111	8	3.18	3.6	11°	20°	r/l	○	●
		1276.0300	RPFT 10 T3 M0-111	10	3.97	4.5	11°	20°	r/l	○	●
		1276.0400	RPFT 12 04 M0-111	12	4.76	5.5	11°	20°	r/l	○	●
	TiAlN	1276.0205	RPFT 06 02 M0-111	6	2.38	3	11°	20°	r/l	○	●
		1276.0245	RPFT 08 03 M0-111	8	3.18	3.6	11°	20°	r/l	○	●
		1276.0305	RPFT 10 T3 M0-111	10	3.97	4.5	11°	20°	r/l	○	●
		1276.0405	RPFT 12 04 M0-111	12	4.76	5.5	11°	20°	r/l	○	●
	AlCrN	1276.0215	RPFT 06 02 M0-111	6	2.38	3	11°	20°	r/l	○	●
		1276.0217	RPFT 06 02 M0-131	6	2.38	3	11°	8°	r/l	○	●
		1276.0255	RPFT 08 03 M0-111	8	3.18	3.6	11°	20°	r/l	○	●
		1276.0257	RPFT 08 03 M0-131	8	3.18	3.6	11°	8°	r/l	○	●
		1276.0315	RPFT 10 T3 M0-111	10	3.97	4.5	11°	20°	r/l	○	●
		1276.0317	RPFT 10 T3 M0-131	10	3.97	4.5	11°	8°	r/l	○	●
		1276.0415	RPFT 12 04 M0-111	12	4.76	5.5	11°	20°	r/l	○	●
		1276.0222	RPFT 06 02 M0-131	6	2.38	3	11°	8°	r/l	○	●
Carbide 12CR	TiAlN	1276.0420*	RPHT 12 04 M0-222	12	4.76	5.5	11°	16°	r/l	○	●
		1276.0430*	RPHT 12 04 M0-222	12	4.76	5.5	11°	16°	r/l	○	●
	AlCrN-VA	1276.0530*	RPFT 12 04 M0-231	11.94	4.6	5.5	11°	6°	r/l	○	●
		1276.0535*	RPFT 12 04 M0-231	11.94	4.6	5.5	11°	6°	r/l	○	●
		1276.0540	RPHT 12 04 M0-722	12	4.76	5.5	11°	16°	r/l	●	○
Carbide CTS-X	TiNox	1276.0540	RPHT 12 04 M0-722	12	4.76	5.5	11°	16°	r/l	●	○
		1276.0560	RPFT 12 04 M0-731	11.94	4.6	5.5	11°	6°	r/l	●	○

*while stocks last



Indexable inserts SCFT HSS and carbide

Indexable inserts

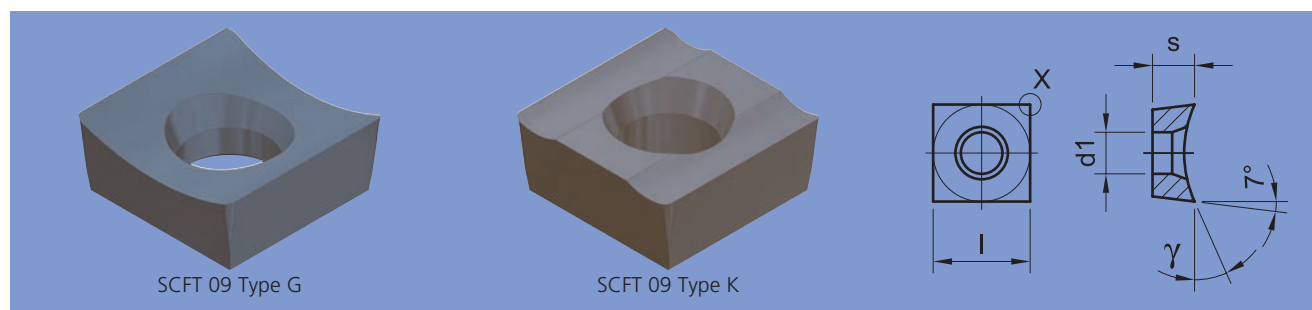

Cutting material	Coating	Part No	ISO Code	Type G/K	l mm	s mm	d1 mm	γ	Detail X			
HSS-E	TiN	1591.0200	SCFT 09 04 04 FN	G	9.52	4	4.5	25°	R 0.4	r/l	●	
		1591.0220	SCFT 09 04 08 FN	G	9.52	4	4.5	25°	R 0.8	r/l	●	
		1591.0250	SCFT 12 05 AC FN	G	12.83	5.56	5.5	24°	0.2x45°	r/l	●	
		1591.0270	SCFT 12 05 04 FN	G	12.83	5.56	5.5	24°	R 0.4	r/l	●	
		1591.0290	SCFT 12 05 08 FN	G	12.83	5.56	5.5	24°	R 0.8	r/l	●	
		1591.0310	SCFT 12 05 12 FN	G	12.83	5.56	5.5	24°	R 1.2	r/l	●	
		1591.0700	SCFT 09 04 04 FN	K	9.52	4	4.5	30°	R 0.4	r/l	●	
		1591.0720	SCFT 09 04 08 FN	K	9.52	4	4.5	30°	R 0.8	r/l	●	
		1591.0770	SCFT 12 05 04 FN	K	12.83	5.56	5.5	30°	R 0.4	r/l	●	
		1591.0790	SCFT 12 05 08 FN	K	12.83	5.56	5.5	30°	R 0.8	r/l	●	
	1591.0810	SCFT 12 05 12 FN	K	12.83	5.56	5.5	30°	R 1.2	r/l	●		
	TiAlN	1666.0200	SCFT 09 04 04 FN	G	9.52	4	4.5	25°	R 0.4	r/l	●	
		1666.0220	SCFT 09 04 08 FN	G	9.52	4	4.5	25°	R 0.8	r/l	●	
		1666.0250	SCFT 12 05 AC FN	G	12.83	5.56	5.5	24°	0.2x45°	r/l	●	
		1666.0270	SCFT 12 05 04 FN	G	12.83	5.56	5.5	24°	R 0.4	r/l	●	
		1666.0290	SCFT 12 05 08 FN	G	12.83	5.56	5.5	24°	R 0.8	r/l	●	
		1666.0310	SCFT 12 05 12 FN	G	12.83	5.56	5.5	24°	R 1.2	r/l	●	
		1666.0700	SCFT 09 04 04 FN	K	9.52	4	4.5	30°	R 0.4	r/l	●	
		1666.0720	SCFT 09 04 08 FN	K	9.52	4	4.5	30°	R 0.8	r/l	●	
		1666.0770	SCFT 12 05 04 FN	K	12.83	5.56	5.5	30°	R 0.4	r/l	●	
1666.0790		SCFT 12 05 08 FN	K	12.83	5.56	5.5	30°	R 0.8	r/l	●		
Carbide MG20	TiAlN	1791.0255	SCFT 12 05 AC FN-111	G	12.83	5.56	5.5	24°	0.2x45°	r/l	○	●
		1791.0295	SCFT 12 05 08 FN-111	G	12.83	5.56	5.5	24°	R 0.8	r/l	○	●
	AlCrN	1791.0265	SCFT 12 05 AC FN-111	G	12.83	5.56	5.5	24°	0.2x45°	r/l	○	●
		1791.0305	SCFT 12 05 08 FN-111	G	12.83	5.56	5.5	24°	R 0.8	r/l	○	●
		1791.0325	SCFT 12 05 08 FN-121	G	12.83	5.56	5.5	14°	R 0.8	r/l	○	●



Indexable inserts MPFT

HSS and carbide

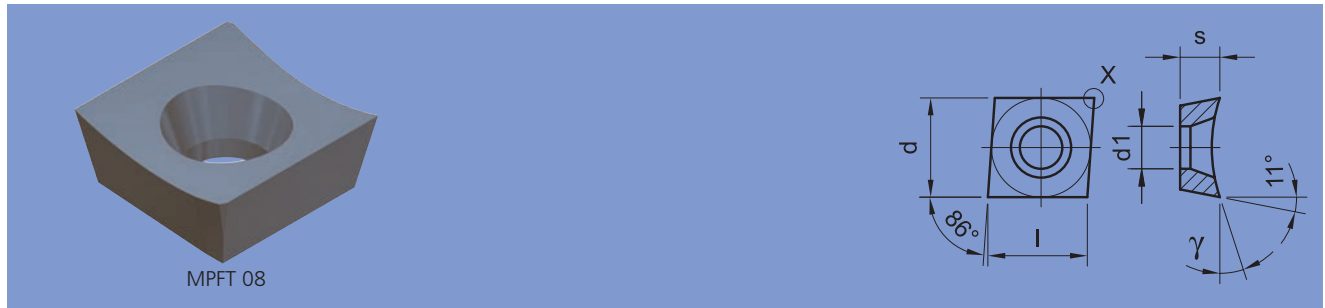

Indexable inserts

Cutting material	Coating	Part No	ISO Code	d mm	s mm	l mm	d1 mm	γ	Detail X			
HSS-E	TiN	1081.0200	MPFT 04 02 PP FR	4.76	2.38	4.7	2.4	18°	0.2x45°	r	●	
		1081.0210	MPFT 04 02 PP FL	4.76	2.38	4.7	2.4	18°	0.2x45°	l	●	
		1081.0250	MPFT 06 02 PP FR	6.35	2.38	6.3	3	18°	0.2x45°	r	●	
		1081.0260	MPFT 06 02 PP FL	6.35	2.38	6.3	3	18°	0.2x45°	l	●	
		1081.0300	MPFT 08 03 PP FR	7.94	3.18	8	3.4	18°	0.2x45°	r	●	
		1081.0310	MPFT 08 03 PP FL	7.94	3.18	8	3.4	18°	0.2x45°	l	●	
	TiAlN	1581.0210	MPFT 04 02 PP FL	4.76	2.38	4.7	2.4	18°	0.2x45°	l	●	
		1156.0200	MPFT 04 02 PP FR	4.76	2.38	4.7	2.4	18°	0.2x45°	r	●	
		1156.0250	MPFT 06 02 PP FR	6.35	2.38	6.3	3	18°	0.2x45°	r	●	
		1156.0300	MPFT 08 03 PP FR	7.94	3.18	8	3.4	18°	0.2x45°	r	●	
		1656.0210	MPFT 04 02 PP FL	4.76	2.38	4.7	2.4	18°	0.2x45°	l	●	
		Carbide MG20	TiN	1281.0425	MPFT 06 02 PP FL-111	6.35	2.38	6.3	3	18°	0.2x45°	l
1281.0400	MPFT 06 02 PP FR-111			6.35	2.38	6.3	3	18°	0.2x45°	r	○	●
1281.0600	MPFT 08 03 PP FR-111			7.94	3.18	8	3.4	18°	0.2x45°	r	○	●
1281.0625	MPFT 08 03 PP FL-111			7.94	3.18	8	3.4	18°	0.2x45°	l	○	●
TiAlN	1281.0405		MPFT 06 02 PP FR-111	6.35	2.38	6.3	3	18°	0.2x45°	r	○	●
	1281.0430		MPFT 06 02 PP FL-111	6.35	2.38	6.3	3	18°	0.2x45°	l	○	●
	1281.0605		MPFT 08 03 PP FR-111	7.94	3.18	8	3.4	18°	0.2x45°	r	○	●
	1281.0630		MPFT 08 03 PP FL-111	7.94	3.18	8	3.4	18°	0.2x45°	l	○	●
AlCrN	1281.0415		MPFT 06 02 PP FR-111	6.35	2.38	6.3	3	18°	0.2x45°	r	○	●
	1281.0440		MPFT 06 02 PP FL-111	6.35	2.38	6.3	3	18°	0.2x45°	l	○	●
	1281.0615		MPFT 08 03 PP FR-111	7.94	3.18	8	3.4	18°	0.2x45°	r	○	●
	1281.0640		MPFT 08 03 PP FL-111	7.94	3.18	8	3.4	18°	0.2x45°	l	○	●



Indexable inserts CCFT HSS

Indexable inserts

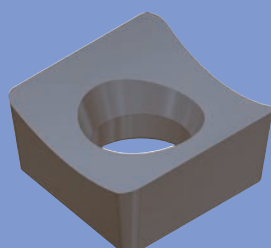

Type G

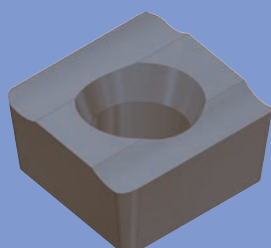

Type K

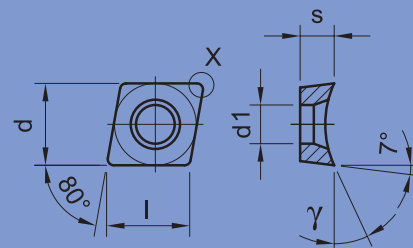

Cutting material	Coating	Part No	ISO Code	Type G/K	d mm	s mm	l mm	d1 mm	γ	Detail X				
HSS-E	TiN	1578.0245	CCFT 06 02 01 FR	G	6.35	2.38	6.4	3	20°	R 0.1	r	●		
		1578.0247	CCFT 06 02 01 FL	G	6.35	2.38	6.4	3	20°	R 0.1	l	●		
		1578.0250	CCFT 06 02 02 FR	G	6.35	2.38	6.4	3	20°	R 0.2	r	●		
		1578.0252	CCFT 06 02 02 FL	G	6.35	2.38	6.4	3	20°	R 0.2	l	●		
		1578.0255	CCFT 06 02 04 FR	G	6.35	2.38	6.4	3	20°	R 0.4	r	●		
		1578.0257	CCFT 06 02 04 FL	G	6.35	2.38	6.4	3	20°	R 0.4	l	●		
		1578.0350	CCFT 09 T3 02 FR	G	9.52	3.96	9.7	4.5	25°	R 0.2	r	●		
		1578.0352	CCFT 09 T3 02 FL	G	9.52	3.96	9.7	4.5	25°	R 0.2	l	●		
		1578.0355	CCFT 09 T3 04 FR	G	9.52	3.96	9.7	4.5	25°	R 0.4	r	●		
		1578.0357	CCFT 09 T3 04 FL	G	9.52	3.96	9.7	4.5	25°	R 0.4	l	●		
		1578.0360	CCFT 09 T3 08 FR	G	9.52	3.96	9.7	4.5	25°	R 0.8	r	●		
		1578.0362	CCFT 09 T3 08 FL	G	9.52	3.96	9.7	4.5	25°	R 0.8	l	●		
		1578.0750	CCFT 06 02 02 FR	K	6.35	2.38	6.4	3	30°	R 0.2	r	●		
		1578.0752	CCFT 06 02 02 FL	K	6.35	2.38	6.4	3	30°	R 0.2	l	●		
		1578.0755	CCFT 06 02 04 FR	K	6.35	2.38	6.4	3	30°	R 0.4	r	●		
		1578.0757	CCFT 06 02 04 FL	K	6.35	2.38	6.4	3	30°	R 0.4	l	●		
		1578.0855	CCFT 09 T3 04 FR	K	9.52	3.96	9.7	4.5	30°	R 0.4	r	●		
		1578.0857	CCFT 09 T3 04 FL	K	9.52	3.96	9.7	4.5	30°	R 0.4	l	●		
	1578.0860	CCFT 09 T3 08 FR	K	9.52	3.96	9.7	4.5	30°	R 0.8	r	●			
	1578.0862	CCFT 09 T3 08 FL	K	9.52	3.96	9.7	4.5	30°	R 0.8	l	●			
	TiAlN		1653.0245	CCFT 06 02 01 FR	G	6.35	2.38	6.4	3	20°	R 0.1	r	●	
			1653.0247	CCFT 06 02 01 FL	G	6.35	2.38	6.4	3	20°	R 0.1	l	●	
			1653.0250	CCFT 06 02 02 FR	G	6.35	2.38	6.4	3	20°	R 0.2	r	●	
			1653.0252	CCFT 06 02 02 FL	G	6.35	2.38	6.4	3	20°	R 0.2	l	●	
			1653.0255	CCFT 06 02 04 FR	G	6.35	2.38	6.4	3	20°	R 0.4	r	●	
			1653.0257	CCFT 06 02 04 FL	G	6.35	2.38	6.4	3	20°	R 0.4	l	●	
			1653.0350	CCFT 09 T3 02 FR	G	9.52	3.96	9.7	4.5	25°	R 0.2	r	●	
			1653.0352	CCFT 09 T3 02 FL	G	9.52	3.96	9.7	4.5	25°	R 0.2	l	●	
			1653.0355	CCFT 09 T3 04 FR	G	9.52	3.96	9.7	4.5	25°	R 0.4	r	●	
			1653.0357	CCFT 09 T3 04 FL	G	9.52	3.96	9.7	4.5	25°	R 0.4	l	●	
			1653.0360	CCFT 09 T3 08 FR	G	9.52	3.96	9.7	4.5	25°	R 0.8	r	●	
			1653.0362	CCFT 09 T3 08 FL	G	9.52	3.96	9.7	4.5	25°	R 0.8	l	●	
			1653.0750	CCFT 06 02 02 FR	K	6.35	2.38	6.4	3	30°	R 0.2	r	●	
			1653.0752	CCFT 06 02 02 FL	K	6.35	2.38	6.4	3	30°	R 0.2	l	●	
			1653.0755	CCFT 06 02 04 FR	K	6.35	2.38	6.4	3	30°	R 0.4	r	●	
			1653.0757	CCFT 06 02 04 FL	K	6.35	2.38	6.4	3	30°	R 0.4	l	●	
			1653.0855	CCFT 09 T3 04 FR	K	9.52	3.96	9.7	4.5	30°	R 0.4	r	●	
			1653.0857	CCFT 09 T3 04 FL	K	9.52	3.96	9.7	4.5	30°	R 0.4	l	●	
			1653.0860	CCFT 09 T3 08 FR	K	9.52	3.96	9.7	4.5	30°	R 0.8	r	●	
			1653.0862	CCFT 09 T3 08 FL	K	9.52	3.96	9.7	4.5	30°	R 0.8	l	●	



Indexable inserts DCFT HSS

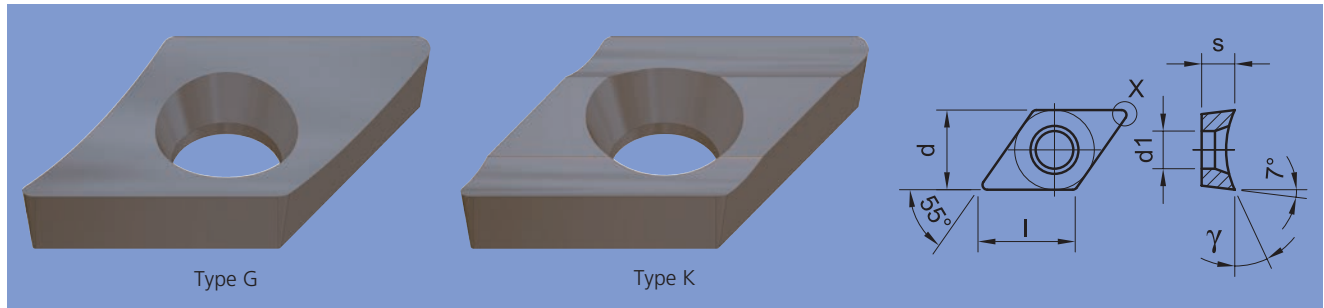

Indexable inserts

Cutting material	Coating	Part No	ISO Code	Type G/K	d mm	s mm	l mm	d1 mm	γ	Detail X			
HSS-E	TiN	1579.0245	DCFT 07 02 01 FR	G	6.35	2.38	7.75	3	20°	R 0.1	r	●	
		1579.0247	DCFT 07 02 01 FL	G	6.35	2.38	7.75	3	20°	R 0.1	l	●	
		1579.0250	DCFT 07 02 02 FR	G	6.35	2.38	7.75	3	20°	R 0.2	r	●	
		1579.0252	DCFT 07 02 02 FL	G	6.35	2.38	7.75	3	20°	R 0.2	l	●	
		1579.0255	DCFT 07 02 04 FR	G	6.35	2.38	7.75	3	20°	R 0.4	r	●	
		1579.0257	DCFT 07 02 04 FL	G	6.35	2.38	7.75	3	20°	R 0.4	l	●	
		1579.0355	DCFT 11 T3 04 FR	G	9.52	3.96	11.6	4.5	25°	R 0.4	r	●	
		1579.0357	DCFT 11 T3 04 FL	G	9.52	3.96	11.6	4.5	25°	R 0.4	l	●	
		1579.0360	DCFT 11 T3 08 FR	G	9.52	3.96	11.6	4.5	25°	R 0.8	r	●	
		1579.0362	DCFT 11 T3 08 FL	G	9.52	3.96	11.6	4.5	25°	R 0.8	l	●	
		1579.0750	DCFT 07 02 02 FR	K	6.35	2.38	7.75	3	30°	R 0.2	r	●	
		1579.0752	DCFT 07 02 02 FL	K	6.35	2.38	7.75	3	30°	R 0.2	l	●	
		1579.0755	DCFT 07 02 04 FR	K	6.35	2.38	7.75	3	30°	R 0.4	r	●	
		1579.0757	DCFT 07 02 04 FL	K	6.35	2.38	7.75	3	30°	R 0.4	l	●	
		1579.0855	DCFT 11 T3 04 FR	K	9.52	3.96	11.6	4.5	30°	R 0.4	r	●	
		1579.0857	DCFT 11 T3 04 FL	K	9.52	3.96	11.6	4.5	30°	R 0.4	l	●	
		1579.0860	DCFT 11 T3 08 FR	K	9.52	3.96	11.6	4.5	30°	R 0.8	r	●	
		1579.0862	DCFT 11 T3 08 FL	K	9.52	3.96	11.6	4.5	30°	R 0.8	l	●	
	1654.0245	DCFT 07 02 01 FR	G	6.35	2.38	7.75	3	20°	R 0.1	r	●		
	1654.0247	DCFT 07 02 01 FL	G	6.35	2.38	7.75	3	20°	R 0.1	l	●		
	1654.0250	DCFT 07 02 02 FR	G	6.35	2.38	7.75	3	20°	R 0.2	r	●		
	1654.0252	DCFT 07 02 02 FL	G	6.35	2.38	7.75	3	20°	R 0.2	l	●		
	1654.0255	DCFT 07 02 04 FR	G	6.35	2.38	7.75	3	20°	R 0.4	r	●		
	1654.0257	DCFT 07 02 04 FL	G	6.35	2.38	7.75	3	20°	R 0.4	l	●		
	1654.0355	DCFT 11 T3 04 FR	G	9.52	3.96	11.6	4.5	25°	R 0.4	r	●		
	1654.0357	DCFT 11 T3 04 FL	G	9.52	3.96	11.6	4.5	25°	R 0.4	l	●		
	1654.0360	DCFT 11 T3 08 FR	G	9.52	3.96	11.6	4.5	25°	R 0.8	r	●		
	1654.0362	DCFT 11 T3 08 FL	G	9.52	3.96	11.6	4.5	25°	R 0.8	l	●		
	1654.0750	DCFT 07 02 02 FR	K	6.35	2.38	7.75	3	30°	R 0.2	r	●		
	1654.0752	DCFT 07 02 02 FL	K	6.35	2.38	7.75	3	30°	R 0.2	l	●		
	1654.0755	DCFT 07 02 04 FR	K	6.35	2.38	7.75	3	30°	R 0.4	r	●		
	1654.0757	DCFT 07 02 04 FL	K	6.35	2.38	7.75	3	30°	R 0.4	l	●		
	1654.0855	DCFT 11 T3 04 FR	K	9.52	3.96	11.6	4.5	30°	R 0.4	r	●		
	1654.0857	DCFT 11 T3 04 FL	K	9.52	3.96	11.6	4.5	30°	R 0.4	l	●		
	1654.0860	DCFT 11 T3 08 FR	K	9.52	3.96	11.6	4.5	30°	R 0.8	r	●		
	1654.0862	DCFT 11 T3 08 FL	K	9.52	3.96	11.6	4.5	30°	R 0.8	l	●		



Indexable inserts SEFT

HSS and carbide

Indexable inserts



Cutting material	Coating	Part No	ISO Code	l mm	s mm	d1 mm	α	γ	Detail X			
HSS-E	TiN	1091.0500	SEFT 12 04 AF FN	12.7	4.76	5.5	20°	12°	1.5x45° R0.8	r/l	●	
	TiAlN	1166.0500	SEFT 12 04 AF FN	12.7	4.76	5.5	20°	12°	1.5x45° R0.8	r/l	●	
Carbide MG20	TiN	1291.0500	SEFT 12 04 AF FN-111	12.7	4.76	5.5	20°	12°	1.5x45° R0.8	r/l	○	●
	TiAlN	1291.0505	SEFT 12 04 AF FN-111	12.7	4.76	5.5	20°	12°	1.5x45° R0.8	r/l	○	●
	AlCrN	1291.0515	SEFT 12 04 AF FN-111	12.7	4.76	5.5	20°	12°	1.5x45° R0.8	r/l	○	●



Indexable inserts VCFT HSS



VCFT 16 Type K

Indexable inserts

Cutting material	Coating	Part No	ISO Code	Type G/K	d mm	s mm	l mm	d1 mm	γ	Detail X			
HSS-E	TiN	1582.0855	VCFT 16 04 04 FR	K	9.52	4.76	16.6	4.5	30°	R 0.4	r	●	
		1582.0857	VCFT 16 04 04 FL	K	9.52	4.76	16.6	4.5	30°	R 0.4	l	●	
		1582.0860	VCFT 16 04 08 FR	K	9.52	4.76	16.6	4.5	30°	R 0.8	r	●	
		1582.0862	VCFT 16 04 08 FL	K	9.52	4.76	16.6	4.5	30°	R 0.8	l	●	
	TiAlN	1657.0855	VCFT 16 04 04 FR	K	9.52	4.76	16.6	4.5	30°	R 0.4	r	●	
		1657.0857	VCFT 16 04 04 FL	K	9.52	4.76	16.6	4.5	30°	R 0.4	l	●	
		1657.0860	VCFT 16 04 08 FR	K	9.52	4.76	16.6	4.5	30°	R 0.8	r	●	
		1657.0862	VCFT 16 04 08 FL	K	9.52	4.76	16.6	4.5	30°	R 0.8	l	●	

Special tools

Your partner for customized system solutions!

You know ALESA Ltd. as the specialists for highly positive and extremely sharply ground cutting inserts of HSS-E and carbide, and for special tools. The competence of ALESA Ltd. covers the entire process from design, engineering, selecting the right cutting materials and coatings, including the application technology.

That is why worldwide ALESA Ltd. is a highly competent partner. The product range includes, in addition to standardized tools, also complete customized system solutions.

Special dimensions

Each standard tool can also be adapted to your individual needs.



HSS tool blanks

According to your drawings and specifications:

Blanks from our main HSS sheet metal camp in Switzerland

- Thickness 0.8 - 6.0 mm
- HSS quality (No. 1.3343) and HSS-E (No. 1.3243 and 1.3247)
- Contour-cut by laser beam
- Raw or flat ground
- Case-hardened and tempered
- Finished ground to thickness
- Suitable, for example, for the manufacturing of flat or circular cutting blades.

We also take over the hardening and tempering of the blanks you have processed.

Sheets in other qualities can also be delivered to us for laser cutting and for possible additional operations.

The blanks that are processed by us are best suited for further processing through wire cutting.

Ask for our non-binding offer.

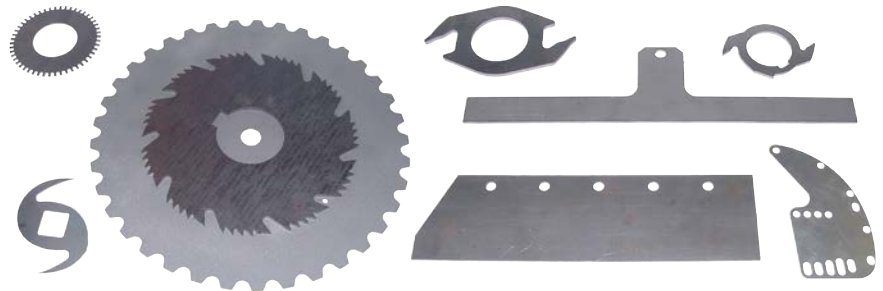

Special plane tools

Because of the hardness of HSS-E, the cutting inserts sustain the movements during entry and exit as well as uninterrupted cutting.

Through cutting insert technology always the same cutting edge geometry and repeat accuracy of measuring. No regrinding.

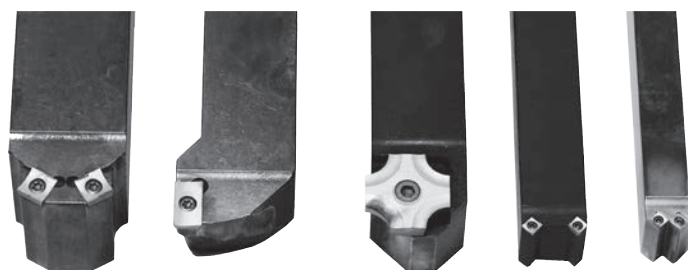

Special tools – examples

Special tools with indexable inserts



Special tools

Special tools for turning and grooving



ISO – Designation system for indexable inserts

A **O** **F** **T** **15** **T3** **08** **F** **R** - **521**

1 2 3 4 5 6 7 8 9 13

Technical information

1 Basic shape		
S		90°
C		80°
D		55°
M		86°
V		35°
A		85°
R		
T		60°

2 Clearance angle	
C	
D	
E	
N	
P	
O	Symbol for other clearance angles which need more detail.

3 Tolerances			
	F	H	E
d	± 0.013	± 0.013	± 0.025
m	± 0.005	± 0.013	± 0.025
s	± 0.025	± 0.025	± 0.025

4 Type of inserts	
T	 for countersunk screws 40°–60° one-side groove for chips
U	 for countersunk screws 40°–60° two-side groove for chips
X	special tools which need more detail

5 Edge length	
S	
C, D, M, V	
L	
A, B	
R	
T	

6 Thickness of inserts	
Index	s
02	2.38
03	3.18
T3	3.97
S4	4.20
04	4.76
05	5.56
06	6.35
07	7.00

7 Corner edge			
Rounded cutting edges			
Index	Radius		
01	0.1 mm		
02	0.2 mm		
04	0.4 mm		
08	0.8 mm		
12	1.2 mm		
16	1.6 mm		
20	2.0 mm		
24	2.4 mm		
32	3.2 mm		
Minor cutting edge			
K		alpha	
A	45°	C	7°
P	90°	D	15°
Z	n. def.	E	20°
		F	25°
		P	11°
		Z	n. def.
Round indexable inserts			
00	For diameter with imperial dimensions in mm		
M0	For diameter in metric dimensions		

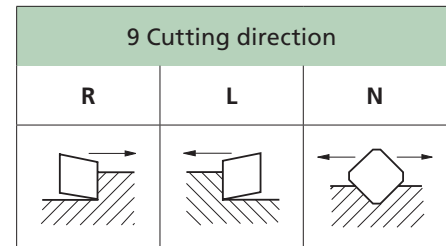
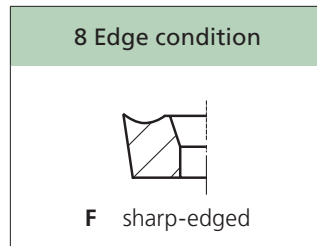

13 Additional number

Substrate		Tool geometry		Features	
0	CTS-G	0	enlarged wedge ↓	0	
1	MG20	1		1	Completely ground
2	12 CR	2		2	Peripheral ground
3	CTS	3		3	Reinforced edge
4	HM	4		4	Special coatings
5	HM-F	5		5	
6	HA	6	6		
7	CTS-X	7		7	
8	KG14	8	fz plus	8	
9	CTM	9	Misc.	9	

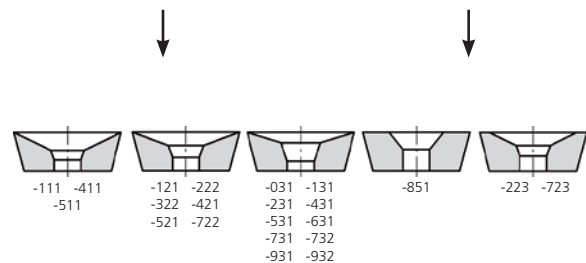

Overview coatings

Applied on ALESA indexable inserts

Technical information

TiN

Hardness 2300 HV 0.05
 Coefficient of friction 0.4
 Max. temperature 600 °C
 Colour gold-yellow

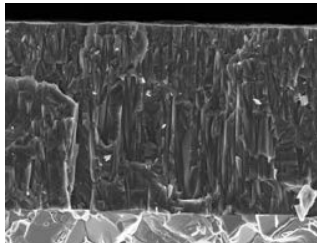

The TiN coating is a universal standard, mainly on HSS tools. It is a good protection against abrasive and adhesive wear. Often applied for decorative reasons or optical wear indicator.

TiAlN

Hardness 3300 HV 0.05
 Coefficient of friction 0.3-0.35
 Max. temperature 900 °C
 Colour violet-grey

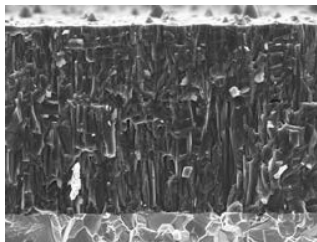

The perfect balance of hardness and compressive stress of TiAlN results in a very stable cutting edge. The excellent thermo and chemical consistency allow dry machining. The very high hardness of TiAlN protects against erosion and abrasive wear.

AlCrN

Hardness 3200 HV 0.05
 Coefficient of friction 0.35
 Max. temperature 1100 °C
 Colour light-grey

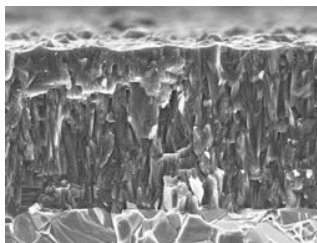

Excellent wear resistance, thermo-shock stability und warm hardness – those are the strength of AlCrN. It is an all-round coating for cutting tools, stamping, metal forming and die-cast aluminum.

AlCrN-VA

Hardness 3200 HV 0.05
 Coefficient of friction 0.3
 Max. temperature 1100 °C
 Colour light-grey

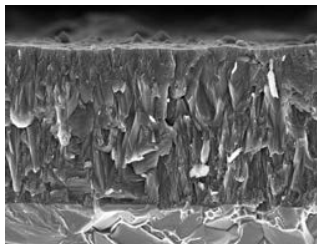

AlCrN-VA performs with a higher wear resistance, higher oxidation resistance and warm hardness. With AlCrN-VA productivity and quality- improved cutting processes can be achieved even in difficult materials and alloys.

TiNox

Hardness >3750 HV 0.05
 Coefficient of friction n.a.
 Max. temperature 1100 °C
 Colour bronze

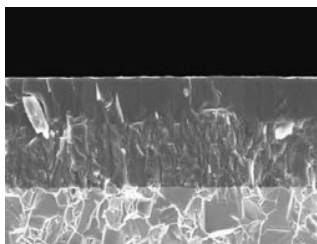

The multilayer PVC coating TiNox combines a strong bonding on carbide with an excellent wear and oxidation resistancy. ALESA recommends the combination of suitable carbide substrate qualities, cutting-edge geometry and TiNox for stainless steel, Duplex-, Nickel based- and Titanium-alloys.

TiNox-G

Hardness >3800 HV 0.05
 Coefficient of friction n.a.
 Max. temperature 1100 °C
 Colour bronze

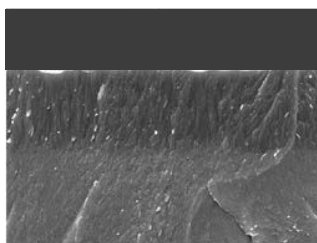

The multi-layer structure AlTiN/TiSiXN is a further development of TiNox. The AlTiN base with a very small crystal structure results in excellent layer adhesion. The top layer out of TiSiXN results in very high hardness and wear resistance. ALESA recommends TiNox-G for fine finishing in cast iron and steel alloys.

DLC-H

Hardness >5000 HV 0.05
 Coefficient of friction 0.15
 Max. temperature 500 °C
 Colour black

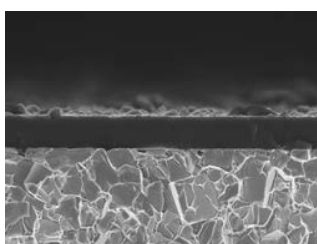

Very high wear resistance, excellent coefficient of friction and perfect ply adhesion those are the properties of DLC-H. This is the top coating for Aluminum and Aluminum alloys up to 12% Silicon, non ferrous metals as Copper, Bronze, Silver, Gold, Platinum as well as GFK and CFK composite, organic materials as wood and paper.

Range of coatings for indexable inserts

Material classification		HSS		Carbide					
		TiN	TiAlN	TiAlN	AlCrN AlCrN-VA	TiN _x	DLC-H	TiN _x -G	special coating
1a	Steels < 650 N/mm² - Construction steels - Fine grain steels - Case hardening steels - Steel castings	●	●	●	●	○		○	
1b	Steels < 800 N/mm² - Construction steels - Fine grain steels - Case hardening steels - Free-cutting steels - Heat-treatable steels - High-temperature constructional steels - Tough at subzero steels - Nitriding steels - Tool steels	●	●	●	●	○		○	
1c	Steels 800 - 1200 Nmm² - Heat-treatable steels - High-temperature constructional steels - Tough at subzero steels - Nitriding steels - Tool steels - High speed steels - Heat-resisting steels		○	●	●	○		○	
1d	Steels > 1200 N/mm² - Heat-treatable steels - Nitriding steels - Tool steels - High speed steels			○	●	○		○	
2a	Stainless steels < 800 N/mm²	●	●	○	●	●			
2b	Stainless steels > 800 N/mm²		●	○	●	●			
2c	DUPLEX & Super DUPLEX >1200 N/mm²		●		○	●			
3a	Castings 1 - Grey cast iron < 150 HB - Cast iron with spheroidal graphite < 200 HB - Malleable cast iron < 200 HB - Magnesium cast alloy			●	●			●	
3b	Castings 2 - Grey cast iron tempered > 150 HB - Cast iron with spheroidal graphite temp. > 200 HB - Malleable cast iron tempered > 200 HB			●	●			●	
3c	Castings 3: Steel castings < 800 N/mm ²		○	●	●			●	
3d	Castings 4: Steel castings 800 - 1200 N/mm ²		○	○	●			●	
3e	Aluminium cast material > 6% Si			●	●		●		○
4a	Non-ferrous metal: Copper and copper-tin alloys	●	○	●	○		●		
4b	Non-ferrous metal - Copper-forging alloys - Copper-tin alloys (bronze)	●	●	●	●		●		
4c	Non-ferrous metal - Pure aluminium - Non hardened aluminium	●	●	●	●		●		
4d	Non-ferrous metal: Hardened aluminium	●	●	●	●		●		
4e	Aluminium cast material < 6% Si	●	●	●	●		●		
5a	Non-alloyed Ni / Ti < 650 N/mm²		●		●	●			●
5b	Ni-/Ti-based alloys < 900 N/mm², Duplex		●		●	●			●
5c	Ni-/Ti-based alloys 900 - 1200 N/mm²				●	●			●
6a	Synthetic material - Thermoplast	●	●	●	●		●		
6b	Synthetic material - Duroplast - Duroplast non laminated - Duroplast laminated	●	●	●	●		●		

Substrate, geometry and coating selection for all ALESA TWIST- and DELTA indexable inserts

Application recommendation for substrate, geometry and coating

Based on the material classification and the tensile strength, the suitable ALESA TWIST indexable insert can be selected by means of the 'cloud' graphics below. The substrate and geometry are defined with a 3 digit number (e.g. 431). You'll find the appropriate coating in the graphics headline.

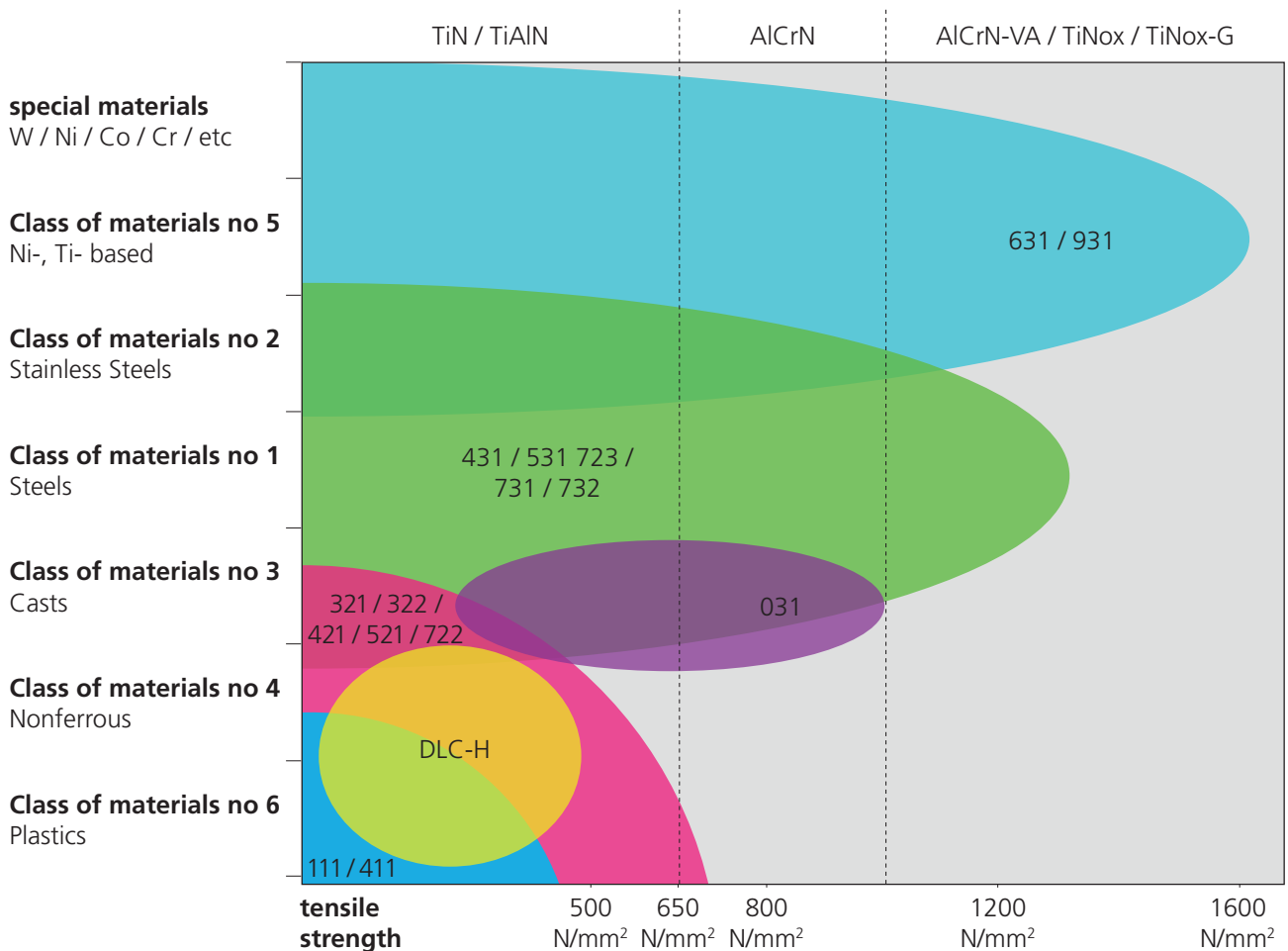

Information about coatings

For carbide tools: PVD-coatings **based on AlCrN** showed best results. Besides the surface hardness of approx. 3'200 HV AlCrN-coatings have an improved application temperature and a good ply adhesion. AlCrN is perfect for material classification 1, 2 & 3. We recommend AlCrN-VAT for Duplex-materials, Material classification 5 and Cobalt-based alloys.

The **DLC-H** coating is very hard with > 5'000 HV. It is a very smooth coating with a low sticking effect of the chips. It has a very low friction coefficient. As a thin layer coating it maintains the sharp ground cutting edges. This coating is for NON – FERRITIC alloys only, as Copper, Tin, Lead, Silver, Gold, Platinum, Alum-alloys and -cast with up to 12% Silicon, GFK and CFK and organic materials as wood and paper. Recommended for application with characteristic abrasion und adhesion behaviour.

Hardness scale

Tensile strength	Vickers	Brinell	Rockwell	
			N/mm2	HV10
720	225	214		
740	230	219		
755	235	223		
770	240	228	20.3	19.9
785	245	233	21.3	21.1
800	250	238	22.2	22.2
820	255	242	23.1	23.2
835	260	247	24	24.3
850	265	252	24.8	25.2
865	270	257	25.6	26.2
880	275	261	26.4	27.1
900	280	266	27.1	27.9
915	285	271	27.8	28.7
930	290	276	28.5	29.5
950	295	280	29.2	30.4
965	300	285	29.8	31.1
995	310	295	31	32.5
1030	320	304	32.2	33.9
1060	330	314	33.3	35.2
1095	340	323	34.4	36.5
1125	350	333	35.5	37.8
1155	360	342	36.6	39.1
1190	370	352	37.7	40.4
1220	380	361	38.8	41.7
1255	390	371	39.8	42.9
1290	400	380	40.8	44.1
1320	410	390	41.8	45.3
1350	420	399	42.7	46.4
1385	430	409	43.6	47.4
1420	440	418	44.5	48.4
1455	450	428	45.3	49.4
1485	460	437	46.1	50.4
1520	470	447	46.9	51.3
1555	480	456	47.7	52.2

Tensile strength	Vickers	Brinell	Rockwell	
			N/mm2	HV
1595	490	466	48.4	53.1
1630	500	475	49.1	53.9
1665	510	485	49.8	54.7
1700	520	494	50.5	55.6
1740	530	504	51.1	56.2
1775	540	513	51.7	57
1810	550	523	52.3	57.8
1845	560	532	53	58.6
1880	570	542	53.6	59.3
1920	580	551	54.1	59.9
1955	590	561	54.7	60.5
1995	600	570	55.2	61.2
2030	610	580	55.7	61.7
2070	620	589	56.3	62.4
2105	630	599	56.8	63
2145	640	608	57.3	63.5
2180	650	618	57.8	64.1
	660		58.3	64.7
	670		58.8	65.3
	680		59.2	65.7
	690		59.7	66.2
	700		60.1	66.7
	720		61	67.7
	740		61.8	68.6
	760		62.5	69.4
	780		63.3	70.2
	800		64	71
	820		64.7	71.8
	840		65.3	72.2
	860		65.9	73.1
	880		66.4	73.6
	900		67	74.2
	920		67.5	74.8
	940		68	75.4

Technical information

Extract from DIN 50150 table A.1 / ISO 18265 table A.1.
Values correspond to non-alloyed steel.

hm [mm] table

Average chip thickness hm for milling with ALESA indexable inserts

Material classification		Face and high feed milling				Profile milling				
		indexable insert	SDFT RPFT	SDHT RPHT XOFU	SDFT XOFU	AOFT	AOFT	TNFU 11	TNFU 18	AOFT
cutting material / inserts geometry		111	222/322	223/732	481/581	HSS	321	321	431/531	631 731/931
1a	Steels < 650 N/mm² - Construction steels - Fine grain steels - Case hardening steels - Steel castings	0.05 - 0.15	0.05 - 0.175	0.08 - 0.19	0.05 - 0.175	0.02 - 0.08	0.03 - 0.045	0.03 - 0.08	0.04 - 0.10	0.04 - 0.09
1b	Steels < 800 N/mm² - Construction steels - Fine grain steels - Case hardening steels - Free-cutting steels - Heat-treatable steels - High-temperature constructional steels - Tough at subzero steels - Nitriding steels - Tool steels	0.04 - 0.10	0.05 - 0.135	0.05 - 0.15	0.05 - 0.135	0.02 - 0.07	0.03 - 0.04	0.03 - 0.06	0.04 - 0.08	0.04 - 0.07
1c	Steels 800 - 1200 Nmm² - Heat-treatable steels - High-temperature constructional steels - Tough at subzero steels - Nitriding steels - Tool steels - High speed steels - Heat-resisting steels		0.04 - 0.10	0.05 - 0.12	0.04 - 0.10	0.015 - 0.050	0.025 - 0.038	0.025 - 0.05	0.03 - 0.065	0.03 - 0.06
1d	Steels > 1200 N/mm² - Heat-treatable steels - Nitriding steels - Tool steels - High speed steels			0.05 - 0.07			0.025 - 0.035	0.025 - 0.045	0.03 - 0.055	0.03 - 0.05
2a	Stainless steels < 800 N/mm²	0.04-0.10	0.05-0.13	0.05-0.15	0.05-0.13	0.02-0.07	0.03-0.04	0.03-0.06	0.04-0.07	0.04-0.07
2b	Stainless steels > 800 N/mm²		0.04-0.10	0.05-0.12	0.04-0.10	0.01-0.05	0.02-0.03	0.02-0.05	0.03-0.06	0.03-0.06
3a	Castings 1 - Grey cast iron < 150 HB - Cast iron with spheroidal graphite < 200 HB - Malleable cast iron < 200 HB - Magnesium cast alloy	0.05 - 0.15	0.05 - 0.175	0.08 - 0.20	0.05 - 0.175		0.03 - 0.05	0.03 - 0.08	0.05 - 0.12	0.05 - 0.12
3b	Castings 2 - Grey cast iron tempered > 150 HB - Cast iron with spheroidal graphite temp. > 200 HB - Malleable cast iron tempered > 200 HB	0.05 - 0.12	0.05 - 0.135	0.05 - 0.15	0.05 - 0.135		0.03 - 0.045	0.03 - 0.06	0.04 - 0.09	0.04 - 0.09
3c	Castings 3: Steel castings < 800 N/mm ²	0.04-0.10	0.05-0.13	0.05-0.15	0.05-0.13	0.02-0.07	0.03-0.04	0.03-0.06	0.04-0.08	0.04-0.07
3d	Castings 4: Steel castings 800 - 1200 N/mm ²		0.05-0.10	0.05-0.12	0.05-0.10	0.01-0.05	0.03-0.04	0.03-0.05	0.03-0.06	0.03-0.06
3e	Aluminium cast material > 6% Si	0.04-0.10	0.05-0.13	0.05-0.15	0.05-0.13	0.02-0.07	0.02-0.05	0.03-0.06	0.04-0.08	0.04-0.08
4a	Non-ferrous metal: Copper and copper-tin alloys	0.05-0.15	0.05-0.17		0.05-0.17	0.02-0.09	0.03-0.06	0.03-0.08	0.04-0.10	0.04-0.09
4b	Non-ferrous metal - Copper-forging alloys - Copper-tin alloys (bronze)	0.04 - 0.10	0.05 - 0.135	0.05 - 0.15	0.05 - 0.135	0.02 - 0.07	0.03 - 0.05	0.03 - 0.065	0.03 - 0.08	0.03 - 0.08
4c	Non-ferrous metal - Pure aluminium - Non hardened aluminium	0.05 - 0.20	0.05 - 0.20		0.05 - 0.20	0.04 - 0.12	0.04 - 0.08	0.04 - 0.10		
4d	Non-ferrous metal: Hardened aluminium	0.05 -0.15	0.05-0.17		0.05-0.17	0.02-0.09	0.03-0.06	0.03-0.08		
4e	Aluminium cast material < 6% Si		0.05-0.13	0.05-0.15	0.05-0.13		0.03-0.04	0.03-0.06	0.04-0.08	0.04-0.08
5a	Non-alloyed Ni / Ti < 650 N/mm²	0.04-0.10	0.05-0.13	0.05-0.15	0.05-0.13	0.01-0.05	0.03-0.04	0.03-0.06	0.03-0.06	0.03-0.06
5b	Ni-/Ti-based alloys < 900 N/mm², Duplex		0.04-0.10	0.05-0.12	0.04-0.10	0.02-0.05	0.03-0.04		0.03-0.05	0.03-0.05
5c	Ni-/Ti-based alloys 900 - 1200 N/mm²		0.03-0.07	0.04-0.10	0.03-0.07				0.03-0.05	0.03-0.05
6a	Synthetic material - Thermoplast	0.05-0.20	0.05-0.20		0.05-0.20	0.04-0.12	0.04-0.10	0.04-0.12		
6b	Synthetic material - Duroplast - Duroplast non laminated - Duroplast laminated	0.05 - 0.20	0.05 - 0.20		0.05 - 0.20	0.02 - 0.09	0.03 - 0.06	0.03 - 0.08		

hm → fz table

Determine the feed per tooth fz by means of the average chip thickness hm

The table shows the feed per tooth fz [mm] to choose for obtaining the required average chip thickness hm.

Table valid for angle Kappa $\kappa = 90^\circ$ (e.g. Profile milling)

		ae in % of the tool diameter														
		5%	10%	15%	20%	25%	30%	35%	40%	45%	50%	60%	70%	80%	90%	100%
average chip thickness hm	0.150 mm	0.677	0.483	0.398	0.348	0.314	0.290	0.271	0.257	0.245	0.236	0.222	0.212	0.208	0.208	0.236
	0.125 mm	0.564	0.402	0.331	0.290	0.262	0.242	0.226	0.214	0.204	0.196	0.185	0.177	0.173	0.173	0.196
	0.100 mm	0.451	0.322	0.265	0.232	0.209	0.193	0.181	0.171	0.163	0.157	0.148	0.142	0.138	0.139	0.157
	0.090 mm	0.406	0.290	0.239	0.209	0.188	0.174	0.163	0.154	0.147	0.141	0.133	0.127	0.125	0.125	0.141
	0.085 mm	0.383	0.273	0.225	0.197	0.178	0.164	0.154	0.146	0.139	0.134	0.126	0.120	0.118	0.118	0.134
	0.080 mm	0.361	0.257	0.212	0.185	0.168	0.155	0.145	0.137	0.131	0.126	0.118	0.113	0.111	0.111	0.126
	0.075 mm	0.338	0.241	0.199	0.174	0.157	0.145	0.136	0.128	0.123	0.118	0.111	0.106	0.104	0.104	0.118
	0.070 mm	0.316	0.225	0.186	0.162	0.147	0.135	0.127	0.120	0.114	0.110	0.103	0.099	0.097	0.097	0.110
	0.065 mm	0.293	0.209	0.172	0.151	0.136	0.126	0.118	0.111	0.106	0.102	0.096	0.092	0.090	0.090	0.102
	0.060 mm	0.271	0.193	0.159	0.139	0.126	0.116	0.109	0.103	0.098	0.094	0.089	0.085	0.083	0.083	0.094
	0.055 mm	0.248	0.177	0.146	0.128	0.115	0.106	0.099	0.094	0.090	0.086	0.081	0.078	0.076	0.076	0.086
	0.050 mm	0.226	0.161	0.133	0.116	0.105	0.097	0.090	0.086	0.082	0.079	0.074	0.071	0.069	0.069	0.079
	0.045 mm	0.203	0.145	0.119	0.104	0.094	0.087	0.081	0.077	0.074	0.071	0.066	0.064	0.062	0.062	0.071
	0.040 mm	0.180	0.129	0.106	0.093	0.084	0.077	0.072	0.068	0.065	0.063	0.059	0.057	0.055	0.056	0.063
	0.035 mm	0.158	0.113	0.093	0.081	0.073	0.068	0.063	0.060	0.057	0.055	0.052	0.050	0.048	0.049	0.055
0.030 mm	0.135	0.097	0.080	0.070	0.063	0.058	0.054	0.051	0.049	0.047	0.044	0.042	0.042	0.042	0.047	
0.020 mm	0.090	0.064	0.053	0.046	0.042	0.039	0.036	0.034	0.033	0.031	0.030	0.028	0.028	0.028	0.031	

Technical information

Table valid for angle Kappa $\kappa = 45^\circ$ (e.g. Face milling)

		ae in % of the tool diameter														
		5%	10%	15%	20%	25%	30%	35%	40%	45%	50%	60%	70%	80%	90%	100%
average chip thickness hm	0.250 mm	1.595	1.138	0.937	0.820	0.740	0.683	0.639	0.605	0.578	0.555	0.522	0.501	0.489	0.491	0.555
	0.225 mm	1.435	1.024	0.844	0.738	0.666	0.615	0.576	0.545	0.520	0.500	0.470	0.451	0.440	0.442	0.500
	0.200 mm	1.276	0.910	0.750	0.656	0.592	0.546	0.512	0.484	0.462	0.444	0.418	0.400	0.391	0.393	0.444
	0.175 mm	1.116	0.796	0.656	0.574	0.518	0.478	0.448	0.424	0.404	0.389	0.365	0.350	0.343	0.343	0.389
	0.160 mm	1.021	0.728	0.600	0.525	0.474	0.437	0.409	0.387	0.370	0.355	0.334	0.320	0.313	0.314	0.355
	0.150 mm	0.957	0.683	0.562	0.492	0.444	0.410	0.384	0.363	0.347	0.333	0.313	0.300	0.294	0.294	0.333
	0.140 mm	0.893	0.637	0.525	0.459	0.415	0.383	0.358	0.339	0.324	0.311	0.292	0.280	0.274	0.275	0.311
	0.130 mm	0.829	0.592	0.487	0.426	0.385	0.355	0.333	0.315	0.300	0.289	0.272	0.260	0.254	0.255	0.289
	0.120 mm	0.765	0.546	0.450	0.393	0.355	0.328	0.307	0.291	0.277	0.267	0.251	0.240	0.235	0.236	0.267
	0.110 mm	0.702	0.501	0.412	0.361	0.326	0.301	0.281	0.266	0.254	0.244	0.230	0.220	0.215	0.216	0.244
	0.100 mm	0.638	0.455	0.375	0.328	0.296	0.273	0.256	0.242	0.231	0.222	0.209	0.200	0.196	0.196	0.222
	0.090 mm	0.574	0.410	0.337	0.295	0.267	0.246	0.230	0.218	0.208	0.200	0.188	0.180	0.176	0.177	0.200
	0.080 mm	0.510	0.364	0.300	0.262	0.237	0.219	0.205	0.194	0.185	0.178	0.167	0.160	0.157	0.157	0.178
	0.070 mm	0.446	0.319	0.262	0.229	0.207	0.191	0.179	0.169	0.162	0.156	0.146	0.140	0.137	0.137	0.156
	0.060 mm	0.383	0.273	0.225	0.197	0.178	0.164	0.153	0.145	0.139	0.133	0.125	0.120	0.117	0.118	0.133
0.050 mm	0.319	0.228	0.187	0.164	0.148	0.137	0.128	0.121	0.116	0.111	0.104	0.100	0.098	0.098	0.111	
0.040 mm	0.255	0.182	0.150	0.131	0.118	0.109	0.102	0.097	0.092	0.089	0.084	0.080	0.078	0.079	0.089	

Table valid for angle Kappa $\kappa = 15^\circ$ (e.g. High feed milling)

		ae in % of the tool diameter														
		5%	10%	15%	20%	25%	30%	35%	40%	45%	50%	60%	70%	80%	90%	100%
average chip thickness hm	0.250 mm	4.357	3.108	2.561	2.239	2.023	1.866	1.747	1.653	1.578	1.517	1.426	1.368	1.337	1.341	1.517
	0.225 mm	3.921	2.797	2.305	2.015	1.821	1.680	1.572	1.488	1.421	1.366	1.284	1.231	1.203	1.206	1.366
	0.200 mm	3.485	2.486	2.049	1.791	1.618	1.493	1.398	1.323	1.263	1.214	1.141	1.094	1.069	1.072	1.214
	0.175 mm	3.050	2.176	1.793	1.567	1.416	1.306	1.223	1.157	1.105	1.062	0.999	0.957	0.936	0.938	1.062
	0.160 mm	2.788	1.989	1.639	1.433	1.295	1.194	1.118	1.058	1.010	0.971	0.913	0.875	0.856	0.858	0.971
	0.150 mm	2.614	1.865	1.537	1.344	1.214	1.120	1.048	0.992	0.947	0.910	0.856	0.821	0.802	0.804	0.910
	0.140 mm	2.440	1.740	1.434	1.254	1.133	1.045	0.978	0.926	0.884	0.850	0.799	0.766	0.749	0.751	0.850
	0.130 mm	2.265	1.616	1.332	1.164	1.052	0.970	0.908	0.860	0.821	0.789	0.742	0.711	0.695	0.697	0.789
	0.120 mm	2.091	1.492	1.229	1.075	0.971	0.896	0.839	0.794	0.758	0.728	0.685	0.656	0.642	0.643	0.728
	0.110 mm	1.917	1.367	1.127	0.985	0.890	0.821	0.769	0.728	0.694	0.668	0.628	0.602	0.588	0.590	0.668
	0.100 mm	1.743	1.243	1.024	0.896	0.809	0.747	0.699	0.661	0.631	0.607	0.571	0.547	0.535	0.536	0.607
	0.090 mm	1.568	1.119	0.922	0.806	0.728	0.672	0.629	0.595	0.568	0.546	0.514	0.492	0.481	0.483	0.546
	0.080 mm	1.394	0.995	0.820	0.717	0.647	0.597	0.559	0.529	0.505	0.486	0.456	0.438	0.428	0.429	0.486
	0.070 mm	1.220	0.870	0.717	0.627	0.566	0.523	0.489	0.463	0.442	0.425	0.399	0.383	0.374	0.375	0.425
	0.060 mm	1.046	0.746	0.615	0.537	0.486	0.448	0.419	0.397	0.379	0.364	0.342	0.328	0.321	0.322	0.364
0.050 mm	0.871	0.622	0.512	0.448	0.405	0.373	0.349	0.331	0.316	0.303	0.285	0.274	0.267	0.268	0.303	
0.040 mm	0.697	0.497	0.410	0.358	0.324	0.299	0.280	0.265	0.253	0.243	0.228	0.219	0.214	0.214	0.243	

References and hints for problem solving

Positioning of the milling tool

favourable

reduced eruption tendency
improved surface finish
longer tool life

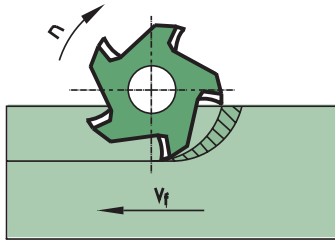

Climb milling vs. conventional milling

Climb milling should always be used unless the machine, clamping system or workpiece is not rigid enough.

unfavourable

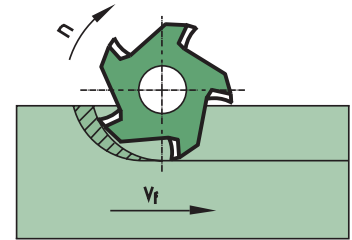

Positioning of milling tool

Where possible the milling cutter should machine tangentially to the workpiece.

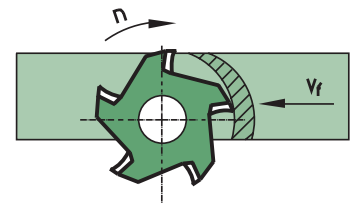
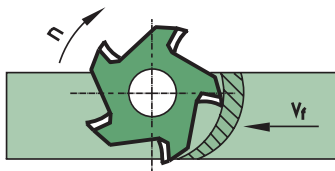

Positioning of workpiece

Where possible to reduce cutting forces the milling cutter should machine tangentially over the complete length of the workpiece.

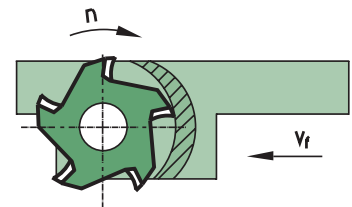
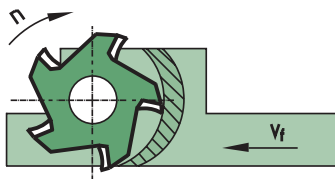

Overlapping

When overlapping extreme caution should be exercised when exiting with the milling cutter (as shown in the left hand sketch).

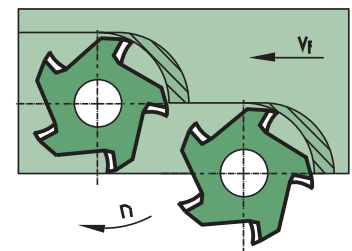
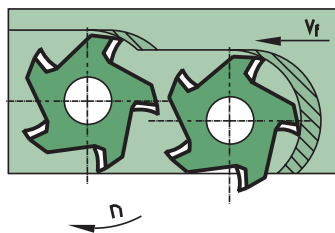



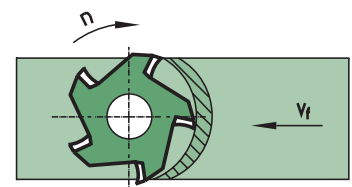
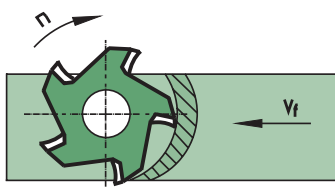

Size of the milling tool

When face milling the diameter of the milling tool should be 20–30% larger than the width of the workpiece.

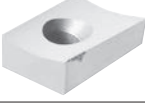
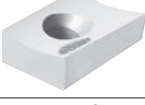
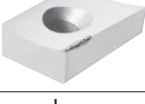

Suggested solutions

Problem	Reason	Cutting speed	Feed	Cutting depth	With coolant	Without coolant	Climb milling	Conventional milling	Coating	Improve chip removal	Change positioning of the cutter	Reduce tool overlapping	Improve stability	Cutting edge angle
 <p>Excessive flank wear</p>	<ul style="list-style-type: none"> Excessive cutting speed Depth of cut too small Feed too low Incorrect milling method 	↓	↑				■		■					
 <p>Excessive wear by indentation</p>	<ul style="list-style-type: none"> Rough surface finish Surface hardening 	↓	↑	↑			■		■		■			■
 <p>Excessive crater wear</p>	<ul style="list-style-type: none"> Increased cutting speed Depth of cut too large Increased cutting temperature 	↓	↓						■					
 <p>Deformation of the cutting edge</p>	<ul style="list-style-type: none"> Increased cutting temperature Too high loading on the face 	↓	↓	↓					■	■	■			■
 <p>Built-up edge</p>	<ul style="list-style-type: none"> Incorrect cutting temperature Feed rate too low Incorrect positioning of the milling cutter Incorrect milling method 	↑	↑			■	■		■		■			
 <p>Cracking</p>	<ul style="list-style-type: none"> Increased feed per tooth Chip compression Chip welding 	↑	↓					■	■	■	■	■	■	
 <p>Thermal cracking</p>	<ul style="list-style-type: none"> Unstable cutting temperature Interrupted cut Poor coolant pressure 	↓	↓			■			■		■			
 <p>Insert breakage</p>	<ul style="list-style-type: none"> Excessive strain on the cutting edge Insert too small Insufficient machine power 	↓	↓	↓							■	■	■	■
<p>Poor surface finish</p>	<ul style="list-style-type: none"> Excessive feed Spindle run out Poor rigidity 	↑	↓	↓	■					■	■	■	■	
<p>Vibration</p>	<ul style="list-style-type: none"> Incorrect cutting data Poor rigidity 	↓	↑	↓				■			■	■	■	
<p>Eruptions at the workpiece edge</p>		↓	↓	↓			■				■			■

↑ = Increase ↓ = Reduce ■ = Remedy

Formulas and calculations

Minimum feed rate

valid for $a_e \leq 30\%$ of the tool diameter

To remain above an average chip thickness of **hm = 0.01 mm**, the feed rate should remain above the following values:

a_e/D :	0.01	0.02	0.04	0.06	0.10	0.30
Min.- f_z :	0.10	0.07	0.05	0.04	0.03	0.02

Milling cutters and full-side cutters

simplified formula to use up to $a_e/D \leq 30\%$

$$h_m \approx f_z \cdot \sqrt{\frac{a_e}{D}}$$

$$f_z \approx h_m \cdot \sqrt{\frac{D}{a_e}}$$

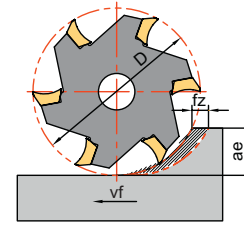

Technical information

General formula for hm and fz

with angle of engaged cutting Φ

$$\Phi = \arcsin\left(1 - \frac{m}{R}\right) + \arcsin\left(\frac{a_e + m}{R} - 1\right)$$

Average chip thickness

$$h_m = \frac{f_z \cdot a_e}{\Phi \cdot R} \cdot \sin(K)$$

Feed per tooth

$$f_z = \frac{h_m \cdot \Phi \cdot R}{a_e} \cdot \frac{1}{\sin(K)}$$

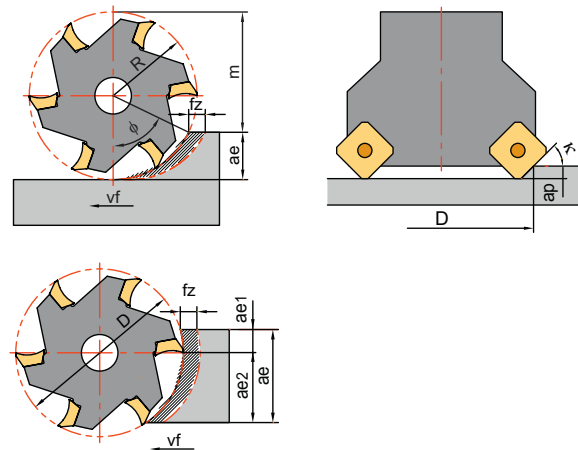

without angle of engaged cutting Φ

Average chip thickness

$$h_m = \frac{f_z \cdot a_e \cdot 360^\circ \cdot \sin(K)}{\pi \cdot D \cdot \left(\arcsin\left(\frac{2 \cdot a_{e1}}{D}\right) + \arcsin\left(\frac{2 \cdot a_{e2}}{D}\right) \right)}$$

Feed per tooth

$$f_z = \frac{h_m \cdot \pi \cdot D \cdot \left(\arcsin\left(\frac{2 \cdot a_{e1}}{D}\right) + \arcsin\left(\frac{2 \cdot a_{e2}}{D}\right) \right)}{\sin(K) \cdot 360^\circ \cdot a_e}$$

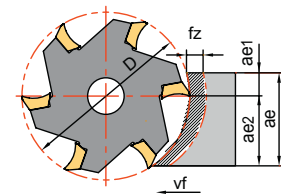

Face milling – above center of workpiece

Average chip thickness

$$h_m = \frac{f_z \cdot a_e \cdot 180^\circ \cdot \sin(K)}{\pi \cdot D \cdot \arcsin\left(\frac{a_e}{D}\right)}$$

Feed per tooth

$$f_z = \frac{h_m \cdot \pi \cdot D \cdot \arcsin\left(\frac{a_e}{D}\right)}{\sin(K) \cdot 180^\circ \cdot a_e}$$

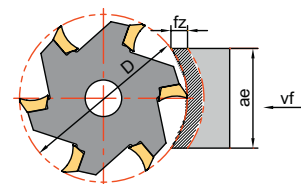

Indexable Inserts

Informationen and instructions

Technical information

Fitting instructions for inserts

1. Tool rest and positioning surface of inserts and milling head must be cleaned carefully.
2. Inserts must lie absolutely flat.
3. Before tightening the screw, the insert has to be pressed onto the positioning surface of the milling head.
4. Then, the screw has to be fully tightened.
5. Screws must be tightened again according to our torque table after initial milling operation.
To be observed particularly when using screws $\leq M 2,5$ (settling)!

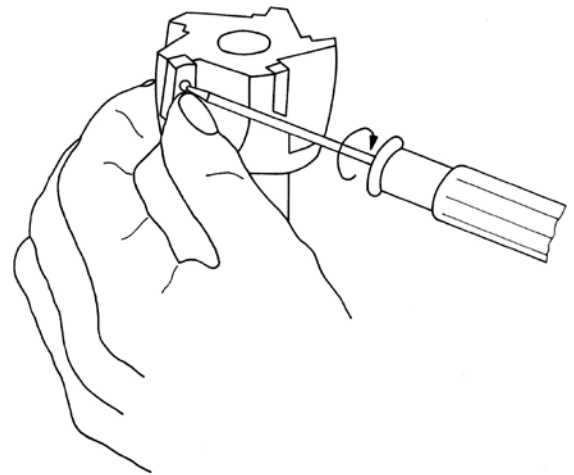

Order of inserts with chip splitting

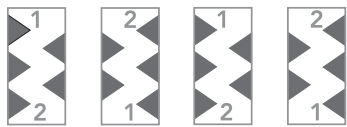

Order of even number of teeth

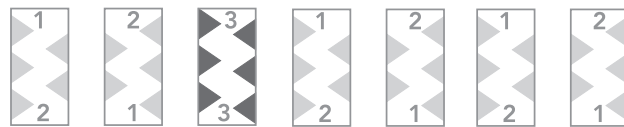

In case of odd number of teeth use indexable insert No 3 once

How to handle the hydroshield on milling head Coolex, No 1340

Removal

1. Loosen the fixing screw (Torx 7IP)
2. Pull out the hydroshield with the screwdriver as shown on the picture.

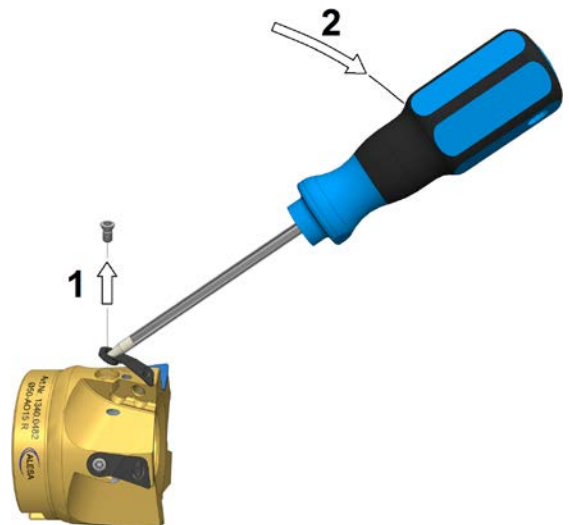
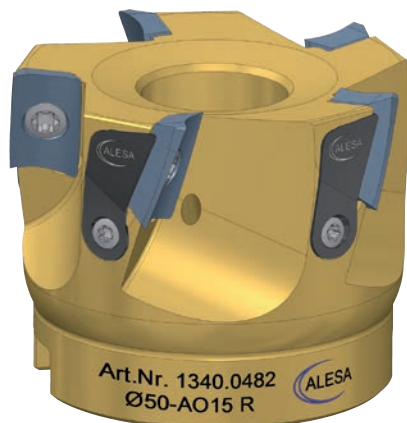

Assembly

Attention: Line up pin (bottom) at first into the positioning groove



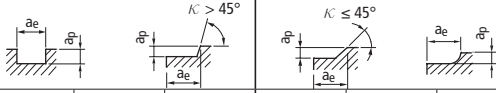
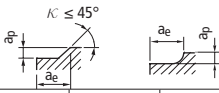

Cutting speed v_c [m/min] - Carbide

Milling with ALESA indexable inserts (carbide)

Material classification	ae = 50% up to 100%			ae = 20% up to 50%			ae = less 20%		
	Slot milling / Face milling			Face milling			Profile milling		
									
Coating	TiN / TiAlN	AlCrN / VA TiN _x	DLC-H	TiN / TiAlN	AlCrN / VA TiN _x	DLC-H	TiN / TiAlN	AlCrN / VA TiN _x	DLC-H
1a Steels < 650 N/mm² - Construction steels - Fine grain steels - Case hardening steels - Steel castings	100 - 240	200 - 300		180 - 280	250 - 350		220 - 320	300 - 400	
1b Steels < 800 N/mm² - Construction steels - Fine grain steels - Case hardening steels - Free-cutting steels - Heat-treatable steels - High-temperature constructional steels - Tough at subzero steels - Nitriding steels - Tool steels	80 - 200	150 - 280		150 - 250	200 - 320		180 - 280	250 - 350	
1c Steels 800 - 1200 Nmm² - Heat-treatable steels - High-temperature constructional steels - Tough at subzero steels - Nitriding steels - Tool steels - High speed steels - Heat-resisting steels	80 - 160	100 - 180		100 - 220	100 - 230		150 - 240	150 - 280	
1d Steels > 1200 N/mm² - Heat-treatable steels - Tool steels - Nitriding steels - High speed steels	80 - 125	80 - 125		100 - 150	100 - 150		100 - 200	100 - 200	
2a Stainless steels < 800 N/mm²	80 - 160	100 - 180		100 - 220	100 - 230		150 - 240	150 - 280	
2b Stainless steels > 800 N/mm²	80 - 125	80 - 125		100 - 150	100 - 150		100 - 200	100 - 200	
2c Stainless DUPLEX & Super DUPLEX >1200 N/mm²		30 - 70			40 - 80			70 - 100	
3a Castings 1 - Grey cast iron < 150 HB - Cast iron with spheroidal graphite < 200 HB - Malleable cast iron < 200 HB - Magnesium cast alloy	80 - 200	150 - 280		150 - 250	200 - 320		180 - 280	250 - 350	
3b Castings 2 - Grey cast iron tempered > 150 HB - Cast iron with spheroidal graphite temp. > 200 HB - Malleable cast iron tempered > 200 HB	80 - 160	100 - 180		100 - 220	100 - 230		150 - 240	150 - 280	
3c Castings 3: Steel castings < 800 N/mm²	80 - 200	150 - 280		150 - 250	200 - 320		180 - 280	250 - 350	
3d Castings 4: Steel castings 800 - 1200 N/mm²	80 - 160	100 - 180		100 - 220	100 - 230		150 - 240	150 - 280	
3e Aluminium cast material > 6% Si	100 - 270	100 - 270	250 - 400	100 - 270	120 - 280	400 - 600	180 - 340	200 - 400	600 - 800
4a Non-ferrous metal: Copper and copper-tin alloys	160 - 300	200 - 400	1000-1500	700-1400	800-1500	1200-1800	800-1500	1000-2000	1500-2000
4b Non-ferrous metal - Copper-forging alloys - Copper-tin alloys (bronze)	100 - 220	800-1200	1000-1500	110 - 230	800-1500	1200-1800	150 - 275	1000-2000	1500-2200
4c Non-ferrous metal - Pure aluminium - Non hardened aluminium	600-1200	800-1500	1000-1500	700-1500	1000-2000	1200-1800	1000-2000	1500-2500	1800-2500
4d Non-ferrous metal: Hardened aluminium	400-1000	600-1200	1000-1500	600-1200	1000-1500	1200-1800	1000-1500	1500-2000	1800-2500
4e Aluminium cast material < 6% Si	200 - 400	500-1000	1000-1500	300 - 500	700-1200	1000-1500	400 - 800	1000-1500	1500-2000
5a Non-alloyed Ni / Ti < 650 N/mm²	80 - 125	80 - 125		100 - 150	100 - 150		100 - 200	100 - 200	
5b Ni-/Ti-based alloys < 900 N/mm², Duplex	25 - 60	25 - 60		40 - 80	40 - 80		80 - 100	80 - 100	
5c Ni-/Ti-based alloys 900 - 1200 N/mm²	20 - 40	20 - 40		30 - 60	30 - 60		40 - 80	40 - 80	
6a Synthetic material - Thermoplast	800-1200	800-1200	800-1500	800-1500	800-1500	1000-1800	1000-2000	1000-2000	1000-2200
6b Synthetic material - Duroplast - Duroplast non laminated - Duroplast laminated	80 - 240	100 - 280	200-400	100 - 250	200 - 300	300 - 500	140 - 300	250 - 350	400 - 600

Cutting speed v_c [m/min] - HSS

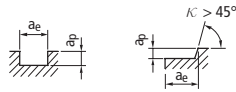
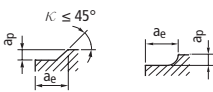
Milling with ALESA indexable inserts (HSS - High Speed Steel)

Material classification		ae = 50% up to 100%		ae = 20% up to 50%		ae = less 20%	
		Slot milling / Face milling 		Face milling 		Profile milling 	
Coating		TiN	TiAlN	TiN	TiAlN	TiN	TiAlN
1a	Steels < 650 N/mm² - Construction steels - Case hardening steels - Fine grain steels - Steel castings	60 - 80	65 - 90	60 - 90	65 - 100	65 - 100	70 - 110
1b	Steels < 800 N/mm² - Construction steels - Heat-treatable steels - Fine grain steels - Tough at subzero steels - Case hardening steels - Nitriding steels - Free-cutting steels - Tool steels - High-temperature constructional steels	40 - 60	50 - 70	50 - 70	55 - 75	55 - 75	60 - 80
1c	Steels 800 - 1200 N/mm² - Heat-treatable steels - High-temperature constructional steels - Tough at subzero steels - Nitriding steels - Tool steels - High speed steels - Heat-resisting steels		35 - 55		40 - 60		40 - 70
1d	Steels > 1200 N/mm² - Heat-treatable steels - Tool steels - Nitriding steels - High speed steels		15 - 35		20 - 40		25 - 45
2a	Stainless steels < 800 N/mm²	40 - 60	50 - 70	50 - 70	55 - 75	55 - 75	60 - 80
2b	Stainless steels > 800 N/mm²		35 - 55		40 - 60		40 - 70
2c	Stainless DUPLEX & Super DUPLEX >1200 N/mm²						
3a	Castings 1 - Grey cast iron < 150 HB - Cast iron with spheroidal graphite < 200 HB - Malleable cast iron < 200 HB - Magnesium cast alloy						
3b	Castings 2 - Grey cast iron tempered > 150 HB - Cast iron with spheroidal graphite temp. > 200 HB - Malleable cast iron tempered > 200 HB						
3c	Castings 3: Steel castings < 800 N/mm ²		35 - 55		40 - 60		40 - 70
3d	Castings 4: Steel castings 800 - 1200 N/mm ²		15 - 35		20 - 40		25 - 45
3e	Aluminium cast material > 6% Si		60 - 130		60 - 150		150 - 300
4a	Non-ferrous metal: Copper and copper-tin alloys	150 - 300	160 - 400	700 - 1300	700 - 1500	800 - 1400	800 - 1600
4b	Non-ferrous metal - Copper-forging alloys - Copper-tin alloys (bronze)	80 - 100	90 - 110	90 - 110	90 - 120	100 - 200	100 - 200
4c	Non-ferrous metal - Pure aluminium - Non hardened aluminium	700 - 1500	700 - 1500	800 - 1600	800 - 1600	1000 - 2000	1000 - 2000
4d	Non-ferrous metal: Hardened aluminium	500 - 1000	500 - 1000	600 - 1200	600 - 1200	800 - 1500	800 - 1500
4e	Aluminium cast material < 6% Si	300 - 500	400 - 600	400 - 600	500 - 700	600 - 800	600 - 1000
5a	Non-alloyed Ni / Ti < 650 N/mm²		50 - 70		55 - 75		60 - 80
5b	Ni-/Ti-based alloys < 900 N/mm², Duplex		15 - 40		20 - 40		25 - 45
5c	Ni-/Ti-based alloys 900 - 1200 N/mm²						
6a	Synthetic material - Thermoplast	250 - 500	250 - 500	400 - 800	400 - 800	800 - 1400	800 - 1400
6b	Synthetic material - Duroplast - Duroplast non laminated - Duroplast laminated	70 - 100	70 - 100	80 - 120	80 - 120	100 - 160	100 - 160

Cutting speed v_c [m/min] - HSS

Turning, Grooving, Planing and Shaping (guide lines)

Material classification	Turning			Grooving		Planing / Shaping	
	v_c	f (45°)	f	v_c	f	v_c	f
1a Steels < 650 N/mm² - Construction steels - Fine grain steels - Case hardening steels - Steel castings	65 - 90	0.15 - 0.40	0.10 - 0.25	65 - 90	0.02 - 0.15	20 - 30	0.05 - 0.30
1b Steels < 800 N/mm² - Construction steels - Fine grain steels - Case hardening steels - Free-cutting steels - Heat-treatable steels - High-temperature constructional steels - Tough at subzero steels - Nitriding steels - Tool steels	50 - 70	0.10 - 0.30	0.10 - 0.20	50 - 70	0.02 - 0.15	20 - 30	0.05 - 0.50
1c Steels 800 - 1200 Nmm² - Heat-treatable steels - High-temperature constructional steels - Tough at subzero steels - Nitriding steels - Tool steels - High speed steels - Heat-resisting steels	35 - 55	0.10 - 0.25	0.08 - 0.15	35 - 55	0.02 - 0.12	10 - 30	0.05 - 0.50
1d Steels > 1200 N/mm² - Heat-treatable steels - Nitriding steels - Tool steels - High speed steels	20 - 40	0.10 - 0.20	0.05 - 0.12	20 - 40	0.02 - 0.10	10 - 20	0.05 - 0.30
2a Stainless steels < 800 N/mm²	35 - 55	0.10 - 0.25	0.08 - 0.15	35 - 55	0.02 - 0.12	10 - 20	0.05 - 0.30
2b Stainless steels > 800 N/mm²	20 - 40	0.10 - 0.20	0.05 - 0.12	20 - 40	0.02 - 0.10	10 - 20	0.05 - 0.30
2c Stainless DUPLEX & Super DUPLEX >1200 N/mm²							
3a Castings 1 - Grey cast iron < 150 HB - Cast iron with spheroidal graphite < 200 HB - Malleable cast iron < 200 HB - Magnesium cast alloy	50 - 70	0.10 - 0.50	0.10 - 0.25	50 - 70	0.02 - 0.15	20 - 30	0.05 - 0.50
3b Castings 2 - Grey cast iron tempered > 150 HB - Cast iron with spheroidal graphite temp. > 200 HB - Malleable cast iron tempered > 200 HB	20 - 40	0.10 - 0.30	0.08 - 0.18	20 - 40	0.02 - 0.10	10 - 20	0.05 - 0.30
3c Castings 3: Steel castings < 800 N/mm²	35 - 55	0.10 - 0.30	0.10 - 0.20	35 - 55	0.02 - 0.12	10 - 20	0.05 - 0.30
3d Castings 4: Steel castings 800 - 1200 N/mm²	20 - 40	0.10 - 0.25	0.08 - 0.15	20 - 40	0.02 - 0.10	10 - 20	0.05 - 0.30
3e Aluminium cast material > 6% Si	60 - 130	0.10 - 0.30	0.10 - 0.20	60 - 130	0.02 - 0.15	40 - 80	0.05 - 1.20
4a Non-ferrous metal: Copper and copper-tin alloys	110 - 180	0.50 - 1.00	0.10 - 0.30	110 - 180	0.02 - 0.15	30 - 45	0.05 - 0.50
4b Non-ferrous metal - Copper-forging alloys - Copper-tin alloys (bronze)	90 - 110	0.10 - 0.25	0.08 - 0.15	90 - 110	0.02 - 0.15	30 - 45	0.05 - 0.50
4c Non-ferrous metal - Pure aluminium - Non hardened aluminium	400 - 900	0.50 - 1.50	0.10 - 0.50	400 - 900	0.02 - 0.18	40 - 80	0.05 - 1.20
4d Non-ferrous metal: Hardened aluminium	140 - 240	0.10 - 0.40	0.10 - 0.25	140 - 240	0.02 - 0.15	40 - 80	0.05 - 1.20
4e Aluminium cast material < 6% Si	140 - 240	0.10 - 0.30	0.10 - 0.20	140 - 240	0.02 - 0.15	40 - 80	0.05 - 1.20
5a Non-alloyed Ni / Ti < 650 N/mm²	50 - 70	0.10 - 0.30	0.10 - 0.20	50 - 70	0.02 - 0.15	20 - 30	0.05 - 0.30
5b Ni-/Ti-based alloys < 900 N/mm², Duplex	20 - 30	0.10 - 0.25	0.08 - 0.15	20 - 30	0.02 - 0.10	8 - 15	0.05 - 0.30
5c Ni-/Ti-based alloys 900 - 1200 N/mm²	10 - 20	0.10 - 0.20	0.05 - 0.12	10 - 20	0.02 - 0.10	6 - 9	0.05 - 0.30
6a Synthetic material - Thermoplast	250 - 900	0.10 - 0.50	0.10 - 0.25	250 - 900	0.02 - 0.18	40 - 80	0.05 - 1.50
6b Synthetic material - Duroplast - Duroplast non laminated - Duroplast laminated	70 - 160	0.10 - 0.25	0.08 - 0.15	70 - 160	0.02 - 0.15	40 - 80	0.05 - 1.50

Allocation of the materials

Cutting conditions

Material	Tensile strength	DIN-No.	DIN-Code	Euronorm EN	AFNOR	B.S.	AISI SAE	Material classification							
Construction steels	< 650 N/mm ²	1.0032 1.0035 1.0037 1.0044 1.0570	St34-2 St33 St37-2 St44-2 St52-3	S25GT S185 S 235 JR S 275 JR S 355 J2 G3	A 33 E 24-2 E 28-2	Fe 310-0 Fe 360 B Fe 430 B FN	A283 Gr.A A283 Gr.C, 1015 A570 Gr.40, 1020	1a							
	< 800 N/mm ²	1.0050 1.0060	St50-2 St60-2	E 295 E 335	A 50-2 A 60-2	Fe 490-2, 50C Fe 590-2 FN	A570 Gr.50 A572 Gr.65	1b							
Fine grain steels	< 650 N/mm ²	1.0970 1.0974 1.0978 1.0980	QStE 260 N QStE 340 TM QStE 380 TM QStE 420 TM	S 260 MC S 340 MC S 380 MC S 420 MC				1a							
	< 800 N/mm ²	1.0982 1.0984 1.0986	QStE 460 TM QStE 500 TM QStE 550 TM	S 460 MC S 500 MC S 550 MC				1b							
Free-cutting steels	< 800 N/mm ²	1.0711 1.0715 1.0718 1.0722 1.0726 1.0737	9S20 9SMn28 9SMnPb28 10SPb20 3S520 9SMnPb36	10S20 9SMn28 11SMnPb30 10SPb20 3S520 11SMnPb37	S 250 S 250 Pb 10 PbF 2 35 MF 6 S 300 Pb	220M07 230M07 212M36	1112 1213 12L13 11L08 1140 12L14	1b							
Case hardening steels	< 650 N/mm ²	1.0301 1.0302 1.0401 1.1121 1.1141 1.7131	C10 C10Pb C15 Ck10 Ck15 16MnCr5	C10 C10 S15R 2C10 E C15E , 32C EN 10084:2008-06	C 10; XC 10 AF34C10 XC18, AF37C12 XC10 XC12 16MC4; 16MnCr5	045M10 045M10 080M15 040A10 080M15 527M20	1010 1010 1015 1010 1015 5115	1a							
	< 800 N/mm ²	1.5752 1.5919 1.5920 1.6587	14NiCr14 15CrNi6 18CrNi8 17CrNiMo6	ECN 35, 36A 15CrNi6 18CrNi8 18CrNiMo7-6	12NC15; 14NC12 16NC6 20NC6 18NCD6	655M13,655A12	3415; 3310 3115	1b							
Heat-treatable steels	< 800 N/mm ²	1.1151 1.1181 1.1191 1.1221 1.7218 1.7220 1.7225 1.7228	Ck22 Ck35 Ck45 Ck60 25CrMo4 34CrMo4 42CrMo4 50CrMo4	C22E C35E C45E C60E, 43D 25CrMo4 19B, 34CrMo4 19A, 42CrMo4 50CrMo4	XC25 XC38H2 XC42H1, XC45 C60; XC60 25CD4 35CD4 42CD4 50CrMo4	055M15 080A35 080M46 060A62 708A25 708A37 709M40 708A47	1023 C1034 1045 1060 4130 4137; 4135 4140, 4142 4150	1b							
		800-1200 N/mm ²	1.0601 1.0966 1.7218 1.7220 1.7225 1.7228 1.5864 1.6580 1.6582 1.7361 1.7707 1.8161	C 60 QStE 690 TM 25CrMo4 34CrMo4 42CrMo4 50CrMo4 35NiCr8 30CrNiMo8 34CrNiMo6 32CrMo12 30CrMoV9 58CrV4	C60 S 700 MC 25CrMo4 19B, 34CrMo4 19A, 42CrMo4 50CrMo4 35NiCr18 30CrNiMo8 EN24T, 34CrNiMo6 40B 30CrMoV9 58CrV4	CC55 25CD4 35CD4 42CD4 50CrMo4 40NC17 30CND8 35NCD6 30CD12	080A62 708A25 708A37 709M40 708A47 823M30 816M40; 817M40 722M24		1060 4130 4137; 4135 4140, 4142 4150	1c					
			> 1200 N/mm ²	1.7218 1.7220 1.7225 1.7228 1.5864 1.6580 1.6582 1.7361 1.7707 1.8161	25CrMo4 34CrMo4 42CrMo4 50CrMo4 35NiCr8 30CrNiMo8 34CrNiMo6 32CrMo12 30CrMoV9 58CrV4	25CrMo4 19B, 34CrMo4 19A, 42CrMo4 50CrMo4 35NiCr18 30CrNiMo8 EN24T, 34CrNiMo6 40B 30CrMoV9 58CrV4	25CD4 35CD4 42CD4 50 CrMo 4 40NC17 30CND8 35NCD6 30CD12		708A25 708A37 709M40 708A47 823M30 816M40; 817M40 722M24		4130 4135; 4137 4140; 4142 4150	1d			
				High-temperature constructional steels	< 800 N/mm ²	1.0482 1.4922 1.5406 1.6513 1.8070	19Mn5 X20CrMoV12-1 17MoV8 4 28NiCrMo4 21CrMoV5 11		P 310 GH SEW310 17MoV8-4 110 21CrMoV5-11		 40NCD3		762 416C 816M40	416C 9840	1b
					> 800 N/mm ²	1.0482 1.4922 1.5406 1.6513 1.8070	19Mn5 X20CrMoV12-1 17MoV8 4 28NiCrMo4 21CrMoV5 11		P 310 GH SEW310 17MoV8-4 110 21CrMoV5-11		 40NCD3		762 816M40	416C 9840	1c
				Tough at subzero steels	< 800 N/mm ²	1.6900 1.7219	X12CrNi189 26CrMo4		26CrMo4					4130, 4130H	1b
	> 800 N/mm ²				1.6900 1.7219	X12CrNi189 26CrMo4	26CrMo4				4130, 4130H		1c		
	Nitriding steels	< 800 N/mm ²		1.8504 1.8506	34CrAl6 31CrAl55					1b					
		800-1200 N/mm ²	1.8507 1.8515 1.8519 1.8523 1.8550	34CrAlMo5 31CrMo12 31CrMoV9 39CrMoV13-9 34CrAlNi7	34CrAlMo5-10 31CrMo12 31CrMoV9 39CrMoV13-9 34CrAlNi7	30CAD6-12 30CD12 40CDV12	722M24 897M39, 3S132	A355CI-D	1c						
			> 1200 N/mm ²	1.8523 1.8550	39CrMoV139 34CrAlNi7	39CrMoV13-9 34CrAlNi7	40CDV12	897M39, 3S132		1d					
		Tool steels	< 800 N/mm ²	1.2056 1.2162 1.2363 1.2519 1.2823	90Cr3 21MnCr5 X100CrMoV5-1 110WCrV5 70Si7	X100CrMoV5-1 110WCrV5 70Si7	Z100CDV5	BA2 A2	1b						

Allocation of the materials

Material	Tensile strength	DIN-No.	DIN-Code	Euronorm EN	AFNOR	B.S.	AISI SAE	Material classification
Tool steels	800-1200 N/mm ²	1.2080	X210Cr12	X210Cr12	Z200C12	BD3	D3	1c
		1.2311	40CrMnMo7	40CrMnNiMo8-6	40CMD8			
		1.2312	40CrMnMoS86	40CrMnNiMoS8-6-4	40CMD8S			
		1.2344	X40CrMoV5-1	X40CrMoV5-1	Z40CDV5	BH13	H13	
		1.2379	X155CrVMo12-1	X155CrVMo12-1	32CDV12-28	BD2	D2	
		1.2436	X210CrW12	X210CrW12	X210CW12-01		D6	
		1.2567	X30WCrV5 3	X30WCrV5-3	X32WCRV5			
		1.2678	X45CoCrWV555	X45CoCrWV5-5-5				
		1.2713	55NiCrMoV6	55NiCrMoV6	55NCD7	BH224/5	L6	
		1.2714	56NiCrMoV7	55NiCrMoV7			6F3	
	1.2743	60NiCrMo124	60NiCrMoV12-4					
	1.2766	35NiCrMo16	35NiCrMo16	35NCD16	BP30			
	> 1200 N/mm ²	1.2080	X210Cr12	X210Cr12	Z200C12	BD3	D3	1d
		1.2311	40CrMnMo7	40CrMnNiMo8-6	40CMD8			
		1.2312	40CrMnMoS86	40CrMnNiMoS8-6-4	40CMD8S			
		1.2344	X40CrMoV5-1	X40CrMoV5-1	Z40CDV5	BH13	H13	
		1.2379	X155CrVMo12-1	X155CrVMo12-1	32CDV12-28	BD2	D2	
		1.2436	X210CrW12	X210CrW12	Z210CW12-01		D6	
		1.2567	X30WCrV5 3	X30WCrV5-3	X32WCRV5			
		1.2678	X45CoCrWV555	X45CoCrWV5-5-5				
1.2713		55NiCrMoV6	55NiCrMoV6	55NCDV7;	BH224/5	L6		
1.2714		56NiCrMoV7	55NiCrMoV7			6F3		
1.2743	60NiCrMo124	60NiCrMoV12-4						
1.2766	35NiCrMo16	35NiCrMo16	35NCD16	BP30				
High speed steels	800-1200 N/mm ²	1.3207	S10-4-3-10	HS 10-4-3-10	Z130WKCDV	BT42		1c
		1.3243	S6-5-2-5	HS 6-5-2-5	Z85WDKCV	BM35		
		1.3247	S2-10-1-8	HS 2-10-1-8	Z110DKCWW	BM42	M42	
		1.3343	S6-5-2	HS 6-5-2	Z85WDCV	BM2	M2 CLASS 1	
	> 1200 N/mm ²	1.3207	S10-4-3-10	HS 10-4-3-10	Z130WKCDV	BT42		1d
		1.3243	S6-5-2-5	HS 6-5-2-5	Z85WDKCV	BM35		
1.3247	S2-10-1-8	HS 2-10-1-8	Z110DKCWW	BM42	M42			
1.3343	S6-5-2	HS 6-5-2	Z85WDCV	BM2	M2 CLASS 1			
Steel castings	< 700 N/mm ²	1.0416	GS-38	EN 10016-2:1995-04	230-400 M	A1		1a
		1.0446	GS-45	GE 240	E23-45 M	A2		
		1.0552	GS-52	S355 JRC				
	< 800 N/mm ²	1.5919	GS-15CrNi6	15CrNi6	16NC6			3c
		1.7218	GS-25CrMo4	25CrMo4	25CD4	708A25	3115	
		1.7220	GC-34CrMo4	19B, 34CrMo4	35CD4	708A37	4130	
		1.7379	GS-18CrMo910	G17CrMo9-10		622	4137; 4135	
	800-1200 N/mm ²	1.0416	GS-38	EN 10016-2:1995-04	230-400 M			3d
		1.0446	GS-45	GE 240	E23-45M	A1		
		1.0552	GS-52	S355 JRC		A2		
		1.5919	GS-15CrNi6	15CrNi6	16NC6		3115	
		1.7218	GS-25CrMo4	25CrMo4	25CD4	708A25	4130	
1.7220	GS-34CrMo4	19B, 34CrMo4	35CD4	708A37	4137; 4135			
1.7379	GS-18CrMo910	G17CrMo9-10		622				
Grey cast iron	< 150 HB	0.6015	GG-15	EN-GJL-150	Ft 15 D	Grade 150	No 25B	3a
		0.6020	GG-20	EN-GJL-200	Ft 20 D	Grade 220	No 30B	
		0.6025	GG-25	EN-GJL-250	Ft 25 D	Grade 260	No 35B	
		0.6030	GG-30	EN-GJL-300	Ft 30 D	Grade 300	No 45B	
Grey cast iron tempered	> 150 HB	0.6015	GG-15	EN-GJL-150	Ft 15 D	Grade 150	No 25B	3b
		0.6020	GG-20	EN-GJL-200	Ft 20 D	Grade 220	No 30B	
		0.6025	GG-25	EN-GJL-250	Ft 25 D	Grade 260	No 35B	
		0.6030	GG-30	EN-GJL-300	Ft 30 D	Grade 300	No 45B	
Cast iron with spheroidal graphite	< 200 HB	0.7040	GGG-40	EN-GJS-400-15	FCS 400-12	SNG 420/12	60-40-18	3a
		0.7050	GGG-50	EN-GJS-500-7	FGS 500-7	SNG 500/7	65-54-12	
		0.7060	GGG-60	EN-GJS-600-3	FGS 600-3	SNG 600/3	80-55-06	
Malleable cast iron	< 200 HB	0.8035	GTW-35-04	EN-GJS-800-2				3a
		0.8040	GTW-40-05	EN-GJS-800-2				
		0.8045	GTW-45-07	EN-GJS-800-2				
		0.8135	GTS-35-10	EN-JM1010	MN 35-10	B 340/12	32510	
		0.8145	GTS-45-06	EN-JM1040	MN 450	P 440/7	40010	
		0.8155	GTS-55-04	EN-JM1050	MP 50-5	P 510/4	50005	
		0.8165	GTS-65-02	GJMB 650-2	MP 60-3	P 570/3	70003	
Cast iron with spheroidal graphite tempered	> 200 HB	0.7040	GGG-40	EN-GJS-400-15	FCS 400-12	SNG 420/12	60-40-18	3b
		0.7050	GGG-50	EN-GJS-500-7	FGS 500-7	SNG 500/7	65-54-12	
		0.7060	GGG-60	EN-GJS-600-3	FGS 600-3	SNG 600/3	80-55-06	
		0.7070	GGG-70	EN-GJS-700-2	FGS 700-2	SNG 700/2	100-70-03	
		0.7080	GGG-80	EN-GJS-800-2				
Malleable cast iron tempered	> 200 HB	0.8035	GTW-35-04	EN-GJS-800-2				3b
		0.8040	GTW-40-05	EN-GJS-800-2				
		0.8045	GTW-45-07	EN-GJS-800-2				
		0.8135	GTS-35-10	EN-JM1010	MN 35-10	B 340/12	32510	
		0.8145	GTS-45-06	EN-JM1040	MN 450	P 440/7	40010	
		0.8155	GTS-55-04	EN-JM1050	MP 50-5	P 510/4	50005	
		0.8165	GTS-65-02	GJMB 650-2	MP 60-3	P 570/3	70003	

Cutting conditions

Allocation of the materials

Cutting conditions

Material	Tensile strength	DIN-No.	DIN-Code	Euronorm EN	AFNOR	B.S.	AISI SAE	Material classification	
Stainless steels	< 850 N/mm ²	1.4104	14CrMoS17	X14CrMoS17-2	Z 3CF17	441S29	430F	2a	
		1.4113	X 6 CrMo 17	X6CrMo17-1	Z8CD17.01	434S17	434		
		1.4301	X5CrNi1810	58E, X5CrNi18-10	Z4CN18-10FF	304S15	304		
		1.4305	X8CrNiS18-9	58M; X10CrNiS18-9	Z8CNF18-09	303S21	303		
		1.4306	X2CrNi19-11	X2CrNi19-11	Z2CN18-10	304S12	304L		
		1.4401	X5CrNiMo17 12 2	G-X6CrNiMo17-12-2	Z6CND17-17-11	316S16	316		
		1.4404	X2CrNiMo17-12-2	X3CrNiMo17122	Z3CND18-12-02	316S12	316L		
		1.4435	X2CrNiMo18-14-3	X2CrNiMo18-14-3	Z2CND18-14-03	316S11	316L		
		1.4436	X3CrNiMo17-13-3	X3CrNiMo17-13-3	Z7CND18-12-03;	316S33	316		
		1.4539	X1NiCrMoCuN25-20-5	X1NiCrMoCu25-20-5	Z2NCDU25-20-5	904S13	904L, N08904		
		1.4541	X6CrNiTi18-10	X6CrNiTi18-10	Z6CNT18-10	321S31	321		
		1.4573	X10CrNiMoTi18-12	X6CrNiMoTi18-12		320S33	316Ti		
		< 1000 N/mm ²	1.4002	X6CrAl13	X6CrAl13	Z6CA13	405S17		405
	1.4006		X10Cr13	56A; X12Cr13	Z10C14	410S21	410, AMS 5613		
	1.4016		X6Cr17	60; X6Cr17	Z8C17	430S17	430/1		
	1.4021		X20Cr13	X20Cr13	Z20C13	420S37	420		
	1.4028		X30Cr13	X30Cr13	Z30C13	420S45	420F		
	1.4034		X46Cr13	56D; X46Cr13	Z38C13M	420S45	420C/4		
	1.4057		X17CrNi16-2	57; X17CrNi16-2	Z15CN16-02	431S29	431		
	1.4112		X90CrMoV18	X90CrMoV18			440B		
	1.4116		X45CrMoV15	X50CrMoV15	A35-572		UNE 36016-1		
	1.4125		X105CrMo17	X105CrMo17	Z100CD17	X105CrMo17	440C		
	1.4460		X3CrNiMoN27-5-2	X3CrNiMoN27-5-2	Z3CND27-07 AZ	X3CrNiMoN27-5-2	329		
	1.4510		X3CrTi17	X6CrTi17	Z4CT17, X3CrTi17	X3CrTi17	430Ti		
	1.4512		X6CrTi12	X5CrTi12	Z3CT12, Z6CT12	409S19	409		
	1.4512	X6CrTi12	X5CrTi12	Z3CT12, Z6CT12	409S19	409			
1.4406	X2CrNiMoN17-11-2	X2CrNiMoN17-12-2	Z2CND17-12-Az	316S16	316LN				
Stainless steel castings	< 850 N/mm ²	1.4308	GX6CrNi18 9	G-X6CrNi18-9	Z6CN18-10M	304C15	304H, CF-8	2a	
	1.4340	G-X40CrNi274	GX40CrNi27-4			J92615, A781-05			
	< 1000 N/mm ²	1.4086	G-X120Cr29	57; X17CrNi16-2	Z15CN16-02	431S29	431	2b	
	1.4106	G-X10CrMo13	X2CrMoSiS18-2-1	X2CrMoSiS18-2-1					
Stainless DUPLEX & Super DUPLEX	>1200 N/mm ²	1.3964	X 2 CrNiMnMoNb 21 16 5 3		NF 05-159		XM-19	2c	
		1.4362	X 2 CrNiN 23 4	X2CrNiN23-4	Z2CN23-04AZ	Z2CN23-04AZ	202S16		UNS S32304
		1.4371	X 2 Cr MnNiN 17 7 5	X2CrMnNiN17-7-5	10088-3, 10272, 10263-2	Z3CND2507Az			201LN, UNS S20153
		1.4410	X 2 CrNiMoN 25 7 4	10088-3, 10272, 10263-2			ASTM A240, S32750		
		1.4429	X 2 CrNiMoN 17 13 3	X2CrNiMoN17-13-3	Z2CND17-13-Az	316S63	316LN		
		1.4460	X 3 CrNiMoN 27 5 2	X3CrNiMoN27-5-2	Z3CND27-07-AZ	X3CrNiMoN27-5-2	329, UNS S32900		
		1.4462	X 2 CrNiMoN 22 5 3	X2CrNiMoN22-5-3	Z3CND22-05-Az	318S13	329A, UNS S31803		
		1.4469	X 2 CrNiMoN 26 7 4	GX2CrNiMoN26-7-4			UNS S32615 / A890(5A) / A995(5A)		
		1.4501	X 2 CrNiMoCuWN 25 7 4	10088-3, 10272, 10263-2	Z3CNDU25-06-Az		329S, UNS S32760, Alloy100		
		1.4529	X 1 NiCrMoCuN 25 20 7	10088-3	X1CrNiMoCuN25-20-7	X1CrNiMoCuN25-20-7	B649, N08926		
		1.4539	X 1 NiCrMoCu 25 20 5	X1NiCrMoCu25-20-5	Z2NCDU25-20-5	904S13	904L, UNS N08904		
		1.4545	X 5 CrNiCuNb 15 5 4	X8CrNiNb14-5	Z7 CNU15.05	15-5PH	AMS 5659, UNS S15500		
		1.4547	X 1 CrNiMoCuN 20 18 7	10088-3 / 10272 / 254 SMO®	X1CrNiMoCuN20-18-7	X1CrNiMo-CuN20-18-7	S31254, 254 SMO®		
1.4662	LDX2404®	X2CrNiMnMo-CuN24-4-3-2			UNS S82441				
Heat-resisting steels	< 1000 N/mm ²	1.4722	X10CrSi13		Z13C13	403S17	405	1c	
		1.4724	X10CrAl13; X10CrAlSi13	X10CrAl11-3					
		1.4741	X10CrSi18						
		1.4742	X10CrAl18	60; X10CrAl(Si)18	Z10CAS18	430S15	430		
		1.4762	X10CrAl24	X10CrAlSi25	Z210CAS24	X10CrAlSi25	446		
		1.4821	X20CrNiSi254		Z20CNS25-4				
Non-alloyed titanium	< 650 N/mm ²	3.7024	Ti 99.5					5a	
		3.7034	Ti 99.7						
		3.7055	Ti 99.4						
		3.7064	Ti 99.2						
Titanium alloys soft-annealed	< 900 N/mm ²	3.7164	TiAl6V4					5b	
		3.7114	TiAl5Sn2						
		3.7124	TiCu2						
		3.7174	TiAl6V6Sn2						
Titanium alloys hardened	900-1250 N/mm ²	3.7164	TiAl6V4					5c	
		3.7124	TiCu2						
		3.7144	TiAl6Sn2Zr4Mo2						
		3.7154	TiAl6Zr5						
		3.7174	TiAl6V6Sn2						
		3.7184	TiAl4Mo4Sn2						
Pure nickel	< 500 N/mm ²	2.4060	Nickel 200					5a	
High temperature nickel-based alloys	< 900 N/mm ²	2.4360	Monel 400					5b	
		2.4375	Monel K 500	Alloy K500					
		2.4812	Hastelloy C		Ni-Mo28	3072 3076 (NA18)	N05500		
		2.4816	Inconel 600			ANC15			
		2.4617	Hastelloy B-2			HR208	N10665		
		2.4665	Hastelloy X			HR204			
		2.4983	Udimet 500						
	1.4876	Incoloy 800		Z8NC32-21	3076NA15H	B163, N08800			
	900-1200 N/mm ²	2.4631	Nimonic 80A			2HR201	NC20TA, HEV5	5c	
		2.4632	Nimonic 90			2HR2	HEV6		
		2.4634	Nimonic 105						
		2.4662	Nimonic 901		Z8NCDT42	HR 53	5660, 5661		
		2.4668	Inconel 718		NC19FeNb	HR 8	N07718, 5662, 5663		
2.4670		Nimocast 713							
2.4674	Nimocast PK24								
2.4856	Inconel 625	499			NA21	B564/446, 5599, 5666			
2.6554	Waspaloy								

Allocation of the materials

Material	Tensile strength	DIN-No.	DIN-Code	Euronorm EN	AFNOR	B.S.	AISI SAE	Material classification
Pure copper	< 350 N/mm ²	2.0060 2.0070 2.0090 2.1356	E-Cu57 SE-Cu SF-Cu CuMn3	CW107C			C19400	4a
Copper-zinc alloys (brass)	< 700 N/mm ²	2.0250 2.0265 2.0321 2.0360 2.0380 2.0410 2.0561 2.0580 2.0771	CuZn20 CuZn30 CuZn37 CuZn40 CuZn39Pb2 CuZn44Pb2 CuZn40Al1 CuZn40Mn1Pb CuNi7Zn39Mn5Pb3	CW713R CW713R		CZ135, CZ114 CZ135, CZ114	C67400 C67400	4a
Copper-forging alloys hardenable	< 800 N/mm ²	2.1245 2.1247 2.1293 2.1525	CuBe1.7 CuBe2 CuCrZr CuSi3Mn	CW107C			C19400	4b
Copper-forging alloys non hardenable	< 600 N/mm ²	2.1201 2.1366 2.1522 2.1525	CuAgo.03 CuMn5 CuSi2Mn CuSi3Mn	CC491K CW107C CW107C CW107C	CuSn5Pb5Zn5	LG2	C83600 C19400 C19400 C19400	4b
Copper-tin alloys (bronze)	< 700 N/mm ²	2.1016 2.1020 2.1030 2.1050 2.1052 2.1060 2.1061 2.1076 2.1080 2.1086 2.1090 2.1093 2.1096	CuSn4 CuSn6 CuSn8 G-CuSn10-C G-CuSn12-C G-CuSn12Ni2-C G-CuSn11Pb2-C CuSn4Pb4Zn4 CuSn6Zn6 G-CuSn10Zn G-CuSn7Zn4Pb7-C G-CuSn6ZnNi G-CuSn5ZnPb	CW450K CW452K CW453K CC480K CC483K CC484K CC482K CW456K CW456K CW456K CC493K CC492K CC491K	CuSn4P CuSn6P CuSn8P, CuSn9 CuSn10P CuSn12P / UE12P CuSn12Ni2 CuSn12Pb CuSn4Pb4Zn4 CuSn4Pb4Zn4 CuSn4Pb4Zn4 CuSn7Pb6Zn4 CuSn7Zn2Pb3 CuSn5Pb5Zn5	PB101 PB103 PB104 CT1/PB4 PB2 CT2 PB4 LG4 LG2	C51100 C51900 C52100 C90700 C90800 C91700 C92500 C54400 C54400 C54400 C93200 C91410 C83600	4b
Pure aluminium	< 150 N/mm ²	3.0255	Al99.5	EN AW-1050A	A-5		1050A	4c
Non hardened aluminium	< 400 N/mm ²	3.0515 3.2315 3.3315 3.3535 3.3547 3.4365	AlMn1 AlMgSi1 AlMg1 AlMg3 AlMg4.5Mn AlZnMgCu1.5	EN AW-3003/3103 EN AW-6082 EN AW-5005A EN AW-5754 EN AW-5083 EN AW-7075	A-M1/- A-SGM0.7 A-G0,6 A-G3M A-G4,5MC A-Z5GU	N3 H30 N41 N8 2L95/96	6082 5005A 5754 5083 7075	4c
Hardened aluminium	< 650 N/mm ²	3.0615 3.1325 3.1355 3.1655 3.4335 3.4345 3.4365	AlMgSiPb AlCuMg1 AlCuMg2 AlCuBiPb AlZn4.5Mg1 AlZnMgCu5.0 AlZnMgCu1.5	EN AW-6012 EN AW-2017A EN AW-2024 EN AW-2011 EN AW-7020 EN AW-7022 EN AW-7075	A-SGPb A-U4G A-U4G1 A-U5PbBi A-Z5G A-Z4GU A-Z5GU	H14 2L97/98 FC1 H17 7021 7020 7022 7075	6012 2017A 2024 2011 7020 7022 7075	4d
Aluminium cast material < 6% Si	< 400 N/mm ²	3.1841 3.2134 3.3241 3.3292	G-AlCu4Ti G-AlSi5Cu1Mg G-AlMg3Si GD-AlMg9	EN AC-AlCu4Ti EN AC-AlCu4Ti EN AW-6061	A-GSUC	H20	6061	4e
Aluminium cast material > 6% Si	< 400 N/mm ²	3.2152 3.2162 3.2373 3.2381 3.2383 3.2581 3.2583 3.2982	GD-AlSi6Cu4 GD-AlSi8Cu3 G-AlSi9Mg G-AlSi10Mg G-AlSi10Mg (Cu) G-AlSi12 G-AlSi12 (12) GD-AlSi12 (Cu)	EN AC-AlSi6Cu4 EN AC-AlSi6Cu4 EN AC-AlSi9Mg EN AC-AlSi10Mg EN AC-AlSi12(a) EN AC-AlSi12(Cu) EN AC-AlSi12Cu1(Fe)				3e
Magnesium cast alloy	< 400 N/mm ²	3.5106 3.5662 3.5812 3.5912	G-MgAg3SE2Zr1 G-MgAl6 G-MgAl8Zn1 G-MgAl9Zn1					3e
Thermoplast		PTFE PVDF PA POM PETP PVC-hart PETP PP PC	Teflon, Hostafilon, Lubriflon Kynar, Solef Ertalon, Ultramid, Nylon Delrin, Hostaform Arnite, Ertalyte Hostalit, Vinoflex, Trovidur Hostalen, Ertalene, Lupolen Hostalen, Ertalen Makralon, Lexan					6a
Duroplast non laminated		PF MF UF	Bakelit, Resalit, Luphen Albamin, Keramin, Resopal Resopal, Basapor					6b
Duroplast laminated		PF MF UF	Ferrozell, Resofil, Canevasit Resopal, Resamin, Textolit Resamin, Basapor					6b

Please contact us, if the DIN standard no. you're searching for, is not mentioned above.

Cutting conditions

Index

Nr.	Typ	Seite
1076		
.0200	RPFT 06 02 MO TiN	65, 114
.0240	RPFT 08 03 MO TiN	65, 114
.0300	RPFT 10 T3 MO TiN	65, 114
.0400	RPFT 12 04 MO TiN	67, 114
.0410	RPFT 12 04 MO TiN	67, 114
.0450	RPFT 12 04 00 TiN	114
1081		
.0200	MPFT 04 02 PP FR TiN	117
.0210	MPFT 04 02 PP FL TiN	117
.0250	MPFT 06 02 PP FR TiN	117
.0260	MPFT 06 02 PP FL TiN	117
.0300	MPFT 08 03 PP FR TiN	117
.0310	MPFT 08 03 PP FL TiN	117
1085		
.0200	APFT 16 04 PD FR TiN	25, 113, 81, 27
.0210	APFT 16 04 PD FL TiN	81, 113
.0230	APFT 16 04 PD FR TiN	25, 27, 81, 113
.0250	APFT 16 04 04 FR TiN	25, 27, 81, 113
.0260	APFT 16 04 04 FL TiN	81, 113
.0300	APFT 16 04 08 FR TiN	25, 113, 81, 27
.0310	APFT 16 04 08 FL TiN	81, 113
.0350	APFT 16 04 12 FR TiN	25, 27, 81, 113
.0360	APFT 16 04 12 FL TiN	81, 113
1087		
.0170	AOFT 10 03 PF FR TiN	13, 15, 107
.0180	AOFT 10 03 04 FR TiN	13, 15, 107
.0190	AOFT 15 T3 PF FR TiN	17, 108, 21, 19
.0210	AOFT 15 T3 08 FR TiN	17, 21, 19, 108
.0215	AOFT 20 04 PF FR TiN	23, 109
.0315	AOFT 20 04 08 FR TiN	23, 109
.0505	AOFT 15 T3 PF FR NO 1/2 TiN	17, 21, 19, 108
.0508	AOFT 15 T3 PF FR NO 3 TiN	17, 21, 19, 108
.0515	AOFT 20 04 PF FR NO 1/2 TiN	23, 109
.0518	AOFT 20 04 PF FR NO 3 TiN	23, 109
1091		
.0400	SDFT 09 T3 AE FN TiN	45, 55, 110, 53, 47
.0450	SDFT 12 04 AE FN TiN	49, 110, 57
.0500	SEFT 12 04 AF FN TiN	120
1151		
.0200	RPFT 06 02 MO TiAIN	65, 114
.0240	RPFT 08 03 MO TiAIN	65, 114
.0300	RPFT 10 T3 MO TiAIN	65, 114
.0400	RPFT 12 04 MO TiAIN	67, 114
.0410	RPFT 12 04 MO TiAIN	67, 114
.0450	RPFT 12 04 00 TiAIN	114
1156		
.0200	MPFT 04 02 PP FR TiAIN	117
.0250	MPFT 06 02 PP FR TiAIN	117
.0300	MPFT 08 03 PP FR TiAIN	117
1160		
.0200	APFT 16 04 PD FR TiAIN	25, 113, 27, 81
.0230	APFT 16 04 PD FR TiAIN	25, 113, 27, 81
.0250	APFT 16 04 04 FR TiAIN	25, 81, 27, 113
.0300	APFT 16 04 08 FR TiAIN	25, 81, 27, 113
.0350	APFT 16 04 12 FR TiAIN	25, 27, 113, 81
1162		
.0170	AOFT 10 03 PF FR TiAIN	13, 15, 107
.0180	AOFT 10 03 04 FR TiAIN	13, 15, 107
.0190	AOFT 15 T3 PF FR TiAIN	17, 21, 19, 108
.0210	AOFT 15 T3 08 FR TiAIN	17, 108, 21, 19
.0215	AOFT 20 04 PF FR TiAIN	23, 109
.0315	AOFT 20 04 08 FR TiAIN	23, 109
1166		
.0400	SDFT 09 T3 AE FN TiAIN	45, 53, 47, 110, 55
.0450	SDFT 12 04 AE FN TiAIN	49, 57, 110
.0500	SEFT 12 04 AF FN TiAIN	120
1276		
.0200	RPFT 06 02 MO-111 TiN	65, 115
.0205	RPFT 06 02 MO-111 TiAIN	65, 115
.0215	RPFT 06 02 MO-111 AlCrN	65, 115
.0217	RPFT 06 02 MO-131 AlCrN	65, 115
.0222	RPFT 06 02 MO-131 AlCrN-VA	65, 115
.0240	RPFT 08 03 MO-111 TiN	65, 115
.0245	RPFT 08 03 MO-111 TiAIN	65, 115
.0255	RPFT 08 03 MO-111 AlCrN	65, 115
.0257	RPFT 08 03 MO-131 AlCrN	65, 115
.0262	RPFT 08 03 MO-131 AlCrN-VA	65, 115
.0300	RPFT 10 T3 MO-111 TiN	65, 115
.0305	RPFT 10 T3 MO-111 TiAIN	65, 115
.0315	RPFT 10 T3 MO-111 AlCrN	65, 115
.0317	RPFT 10 T3 MO-131 AlCrN	65, 115
.0322	RPFT 10 T3 MO-131 AlCrN-VA	65, 115
.0400	RPFT 12 04 MO-111 TiN	67, 115
.0405	RPFT 12 04 MO-111 TiAIN	67, 115
.0415	RPFT 12 04 MO-111 AlCrN	67, 115
.0420	RPHT 12 04 MO-222 TiAIN	67, 115

Nr.	Typ	Seite
.0430	RPHT 12 04 MO-222 AlCrN	67, 115
.0530	RPFT 12 04 MO-231 AlCrN	67, 115
.0535	RPFT 12 04 MO-231 AlCrN-VA	67, 115
.0540	RPHT 12 04 MO-722 TiN _{ox}	67, 115
.0560	RPFT 12 04 MO-731 TiN _{ox}	67, 115
1279		
.0200	XOFU 06 05 08 FR-322 AlCrN-VA	43, 112
.0267	XOFU 06 05 08 FR-732 TiN _{ox}	43, 112
.0317	XOFU 06 05 08 FR-932 TiN _{ox}	43, 112
1281		
.0400	MPFT 06 02 PP FR-111 TiN	117
.0405	MPFT 06 02 PP FR-111 TiAIN	117
.0415	MPFT 06 02 PP FR-111 AlCrN	117
.0425	MPFT 06 02 PP FL-111 TiN	117
.0430	MPFT 06 02 PP FL-111 TiAIN	117
.0440	MPFT 06 02 PP FL-111 AlCrN	117
.0600	MPFT 08 03 PP FR-111 TiN	117
.0605	MPFT 08 03 PP FR-111 TiAIN	117
.0615	MPFT 08 03 PP FR-111 AlCrN	117
.0625	MPFT 08 03 PP FL-111 TiN	117
.0630	MPFT 08 03 PP FL-111 TiAIN	117
.0640	MPFT 08 03 PP FL-111 AlCrN	117
1285		
.0200	APFT 16 04 PD FR-111 TiN	25, 113, 81, 27
.0205	APFT 16 04 PD FR-111 TiAIN	25, 81, 113, 27
.0215	APFT 16 04 PD FR-111 AlCrN	25, 113, 81, 27
.0250	APFT 16 04 04 FR-111 TiN	25, 27, 113, 81
.0255	APFT 16 04 04 FR-111 TiAIN	25, 27, 81, 113
.0265	APFT 16 04 04 FR-111 AlCrN	25, 27, 81, 113
.0300	APFT 16 04 08 FR-111 TiN	25, 27, 81, 113
.0305	APFT 16 04 08 FR-111 TiAIN	25, 81, 27, 113
.0315	APFT 16 04 08 FR-111 AlCrN	25, 27, 81, 113
.0400	APHT 16 04 PD FR-222 TiAIN	25, 81, 27, 113
.0410	APHT 16 04 PD FR-222 AlCrN	25, 27, 113, 81
.0515	APFT 16 04 PD FR-121 AlCrN	25, 81, 113, 27
.0520	APFT 16 04 PD FR-121 AlCrN-VA	25, 113, 27, 81
.0615	APFT 16 04 08 FR-121 AlCrN	25, 113, 27, 81
.0620	APFT 16 04 08 FR-121 AlCrN-VA	25, 27, 113, 81
1287		
.0200	AOFT 10 03 PF FR-411 TiN	13, 107, 15
.0205	AOFT 10 03 04 FR-411 TiN	13, 107, 15
.0210	AOFT 15 T3 PF FR-411 TiN	17, 21, 19, 108
.0215	AOFT 15 T3 08 FR-411 TiN	17, 21, 19, 108
.0225	AOFT 20 04 PF FR-411 TiN	23, 109
.0230	AOFT 20 04 08 FR-411 TiN	23, 109
.0300	AOFT 10 03 PF FR-411 TiAIN	13, 107, 15
.0305	AOFT 10 03 04 FR-411 TiAIN	13, 15, 107
.0310	AOFT 15 T3 PF FR-411 TiAIN	17, 108, 21, 19
.0315	AOFT 15 T3 08 FR-411 TiAIN	17, 21, 19, 108
.0325	AOFT 20 04 PF FR-411 TiAIN	23, 109
.0330	AOFT 20 04 08 FR-411 TiAIN	23, 109
.0510	AOFT 15 T3 PF FR-511 TiAIN	17, 19, 108
.0515	AOFT 15 T3 08 FR-511 TiAIN	17, 19, 108
.0525	AOFT 20 04 PF FR-511 TiAIN	23, 109
.0530	AOFT 20 04 08 FR-511 TiAIN	23, 109
.0651	AOFT 10 03 PF FR-421 AlCrN	13, 107, 15
.0656	AOFT 10 03 04 FR-421 AlCrN	13, 107, 15
.0657	AOFT 10 03 04 FR-431 AlCrN	13, 107, 15
.0661	AOFT 15 T3 PF FR-421 AlCrN	17, 108, 21, 19
.0666	AOFT 15 T3 08 FR-421 AlCrN	17, 21, 19, 108
.0667	AOFT 15 T3 08 FR-431 AlCrN	17, 108, 21, 19
.0669	AOFT 15 T3 12 FR-421 AlCrN	17, 21, 19, 108
.0671	AOFT 15 T3 16 FR-421 AlCrN	17, 21, 19, 108
.0673	AOFT 15 T3 20 FR-421 AlCrN	17, 108, 19, 21
.0676	AOFT 20 04 PF FR-421 AlCrN	23, 109
.0681	AOFT 20 04 08 FR-421 AlCrN	23, 109
.0682	AOFT 20 04 08 FR-431 AlCrN	23, 109
.0701	AOFT 10 03 PF FR-521 AlCrN	13, 15, 107
.0706	AOFT 10 03 04 FR-521 AlCrN	13, 107, 15
.0707	AOFT 10 03 04 FR-531 AlCrN	13, 15, 107
.0711	AOFT 15 T3 PF FR-521 AlCrN	17, 108, 19
.0716	AOFT 15 T3 08 FR-521 AlCrN	17, 108, 19
.0717	AOFT 15 T3 08 FR-531 AlCrN	17, 108, 19
.0718	AOFT 15 T3 08 FR 40 AlCrN	39, 108
.0719	AOFT 15 T3 08 FR 50-63 AlCrN	39, 108
.0720	AOFT 15 T3 08 FR80-125 AlCrN	39, 108
.0726	AOFT 20 04 PF FR-521 AlCrN	23, 109
.0731	AOFT 20 04 08 FR-521 AlCrN	23, 109
.0735	AOFT 20 04 08 FR-531 AlCrN	23, 109
.0757	AOFT 10 03 04 FR-431 AlCrN-VA	13, 15, 107
.0767	AOFT 15 T3 08 FR-431 AlCrN-VA	17, 19, 21, 108
.0782	AOFT 20 04 08 FR-431 AlCrN-VA	23, 109
.0807	AOFT 10 03 04 FR-531 AlCrN-VA	13, 107, 15
.0817	AOFT 15 T3 08 FR-531 AlCrN-VA	17, 108, 19
.0835	AOFT 20 04 08 FR-531 AlCrN-VA	23, 109
.0916	AOFT 15 T3 08 FR-421 DLC-H	17, 108, 19, 21
.0967	AOFT 15 T3 08 FR-531 DLC-H	17, 108, 19
1288		
.0300	AOFT 10 03 ZZ FR-481 AlCrN	59, 61, 107

Nr.	Typ	Seite
.0500	AOFT 10 03 ZZ FR-581 AlCrN	59, 107, 61
.0700	AOFT 10 03 ZZ FR-681 TiN _{ox}	59, 107, 61
1289		
.0202	AOFT 10 03 04 FR-631 AlCrN-VA	13, 107, 15
.0232	AOFT 15 T3 08 FR-631 AlCrN-VA	17, 21, 19, 108
.0262	AOFT 20 04 08 FR-631 AlCrN-VA	23, 109
1291		
.0320	SDHT 09 T3 AE FN-722 TiN _{ox}	45, 55, 53, 110, 47
.0370	SDHT 12 04 AE FN-722 CTS-X TiN _{ox}	49, 110, 57
.0400	SDFT 09 T3 AE FN-111 TiN	45, 110, 53, 47, 55
.0405	SDFT 09 T3 AE FN-111 TiAIN	45, 110, 55, 53, 47
.0415	SDFT 09 T3 AE FN-111 AlCrN	45, 53, 47, 55, 110
.0420	SDHT 09 T3 AE FN-222 TiAIN	45, 55, 53, 47, 110
.0430	SDHT 09 T3 AE FN-222 AlCrN	45, 47, 55, 110, 53
.0450	SDFT 12 04 AE FN-111 TiN	49, 57, 110
.0455	SDFT 12 04 AE FN-111 TiAIN	49, 110, 57
.0465	SDFT 12 04 AE FN-111 AlCrN	49, 57, 110
.0470	SDHT 12 04 AE FN-222 TiAIN	49, 110, 57
.0480	SDHT 12 04 AE FN-222 AlCrN	49, 110, 57
.0500	SEFT 12 04 AF FN-111 TiN	120
.0505	SEFT 12 04 AF FN-111 TiAIN	120
.0515	SEFT 12 04 AF FN-111 AlCrN	120
.0520	SDFT 09 T3 AE FN-723 TiN _{ox}	45, 47, 55, 110, 53
.0570	SDFT 12 04 AE FN-723 CTS-X TiN _{ox}	49, 57, 110
.0630	SDFT 09 T3 AE FN-223 AlCrN	45, 53, 47, 110, 55
.0635	SDFT 09 T3 AE FN-223 AlCrN-VA	45, 53, 47, 55, 110
.0640	SDFT 09 T3 AE FN-223 DLC-H	45, 53, 47, 55, 110
.0680	SDFT 12 04 AE FN-223 AlCrN	49, 57, 110
.0685	SDFT 12 04 AE FN-223 AlCrN-VA	49, 57, 110
.0690	SDFT 12 04 AE FN-223 DLC-H	49, 57, 110
.0720	SDFT 09 T3 AE FN-223 AlCrN-VA	53, 110, 55
.0770	SDFT 12 04 AE FN-223 AlCrN-VA	57, 110
1292		
.0200	SDFT 09 T3 AE FN-851 AlCrN-K	45, 47, 55, 53, 110
.0225	SDFT 12 04 AE FN-851 AlCrN-K	49, 110, 57
1297		
.0200	TNFU 11 S4 04 FR-321 AlCrN-VA	9, 31, 33, 111, 11
.0201	TNFU 11 S4 04 FR-321 DLC-H	9, 33, 111, 11, 31
.0267	TNFU 11 S4 04 FR-731 TiN _{ox}	9, 11, 111, 33, 31
.0317	TNFU 11 S4 04 FR-931 TiN _{ox}	9, 11, 31, 111, 33
.0650	TNFU 11 S4 PF FR-321 AlCrN-VA	9, 111, 33, 31, 11
.0651	TNFU 11 S4 PF FR-321 DLC-H	9, 31, 111, 33, 11
.0717	TNFU 11 S4 PF FR-731 TiN _{ox}	9, 33, 11, 31, 111
1298		
.0200	TNFU 18 07 08 FR-321 AlCrN-VA	11, 33, 37, 111
.0201	TNFU 18 07 08 FR-321 DLC-H	11, 111, 37, 33
.0267	TNFU 18 07 08 FR-731 TiN _{ox}	11, 37, 33, 111
.0317	TNFU 18 07 08 FR-931 TiN _{ox}	11, 111, 37, 33
.0318	TNFU 18 07 08 FR-931 TiN _{ox}	11, 37, 33, 111
.0650	TNFU 18 07 PF FR-321 AlCrN-VA	11, 33, 111
.0651	TNFU 18 07 PF FR-321 DLC-H	

Index

Nr.	Typ	Seite
.0560	125 - AP 16 R	26
.0580	160 - AP 16 R	26
1311		
.0422	32 - AO 10 R	14, 60
.0460	40 - AO 15 R	18
.0462	40 - AO 10 R	14, 60
.0464	40 - AO 15 R einstellbar	38
.0480	50 - AO 15 R	18
.0482	50 - AO 10 R	14, 60
.0484	50 - AO 15 R einstellbar	38
.0500	63 - AO 15 R	18
.0504	63 - AO 15 R einstellbar	38
.0520	80 - AO 15 R	18
.0524	80 - AO 15 R einstellbar	38
.0544	100 - AO 15 R einstellbar	38
.0564	125 - AO 15 R einstellbar	38
1312		
.0480	50 - AO 20 R	22
.0500	63 - AO 20 R	22
.0520	80 - AO 20 R	22
.0540	100 - AO 20 R	22
1316		
.0460	40 - SD 09 R	46
.0480	50 - SD 09 R	46
.0500	63 - SD 09 R	46
.0520	80 - SD 09 R	46
.0540	100 - SD 09 R	46
1318		
.0420	D32 - SD 09 R Z4	54
.0460	D40 - SD 09 R Z5	54
.0480	D50 - SD 09 R Z6	54
1319		
.0480	50 - SD 12 R Z=4	48
.0482	50 - SD 12 R Z=5	48
.0500	63 - SD 12 R Z=5	48
.0502	63 - SD 12 R Z=7	48
.0520	80 - SD 12 R Z=6	48
.0522	80 - SD 12 R Z=8	48
.0540	100 - SD 12 R Z=7	48
.0542	100 - SD 12 R Z=10	48
.0560	125 - SD 12 R Z=8	48
.0562	125 - SD 12 R Z=11	48
.0580	160 - SD 12 R Z=10	48
.0582	160 - SD 12 R Z=14	48
1322		
.0480	50 - SD 12 R Z5	56
.0500	63 - SD 12 R Z6	56
.0530	83 - SD 12 R Z7	56
1326		
.0240	12 - RP 06 R	64
.0300	16 - RP 08 R	64
.0340	20 - RP 10 R	64
1327		
.0300	16 - RP 06 R	64
.0340	20 - RP 06 R	64
.0380	25 - RP 08 R	64
.0420	32 - RP 10 R	64
1330		
.0462	40 - XO 06 R	42
.0482	50 - XO 06 R	42
.0502	63 - XO 06 R	42
.0522	80 - XO 06 R	42
.0542	100 - XO 06 R	42
.0562	125 - XO 06 R	42
.0582	160 - XO 06 R	42
.0584	160 - XO 06 R	42
1340		
.0462	40 - AO 15 R Coolex	20
.0482	50 - AO 15 R Coolex	20
.0502	63 - AO 15 R Coolex	20
1345		
.0380	25 - AP 16 R	24
.0420	32 - AP 16 R	24
.0460	40 - AP 16 R	24
1347		
.0300	16/16 - AO 10 R	12, 58
.0338	20/20 - AO 10 R Z 2	12, 58
.0340	20/20 - AO 10 R Z 3	12, 58
.0378	25/20 - AO 15 R	16
.0380	25/25 - AO 15 R	16
.0382	25/25 - AO 10 R	12, 58
.0408	32/25 - AO 15 R Z 2	16
.0410	32/25 - AO 15 R Z 3	16
.0418	32/32 - AO 15 R Z 2	16
.0420	32/32 - AO 15 R Z 3	16
.0458	40/32 - AO 15 R Z 2	16
.0460	40/32 - AO 15 R Z 4	16

Nr.	Typ	Seite
1348		
.0300	16 - AO 10 R	12, 58
.0340	20 - AO 10 R	12, 58
.0380	25 - AO 15 R	16
.0382	25 - AO 10 R	12, 58
.0418	32 - AO 15 R Z 2	16
.0420	32 - AO 15 R Z 3	16
.0422	32 - AO 10 R	12, 58
1349		
.0300	16 - SD 09 R	44
.0340	20 - SD 09 R	44
.0380	25 - SD 09 R	44
.0420	32 - SD 09 R	44
1352		
.0240	D12 - SD 09 R Z2	52
.0300	D16 - SD 09 R Z2	52
.0305	D16 - SD 09 R Z3	52
.0380	D25 - SD 09 R Z3	52
1353		
.0240	D12 - SD 09 R Z2	52
.0300	D16 - SD 09 R Z2	52
.0305	D16 - SD 09 R Z3	52
.0380	D25 - SD 09 R Z3	52
1354		
.0382	25 - TN 11 R Schaft	30
.0384	25 - TN 11 R Einschraub	30
.0422	32 - TN 11 R Schaft	30
.0424	32 - TN 11 R Einschraub	30
.0463	43 - TN 11 R Aufsteck	32
1356		
.0463	43 - TN 18 R Aufsteck	32
.0483	53 - TN 18 R Aufsteck	32
.0503	66 - TN 18 R Aufsteck	32
.0523	83 - TN 18 R Aufsteck	32
1576		
.0200	RCFT 06 02 MO TiN	71, 114
.0240	RCFT 08 03 MO TiN	71, 114
.0250	RCFT 08 03 MO TiN	114
.0300	RCFT 10 T3 MO TiN	71, 114
.0400	RCFT 12 04 MO TiN	71, 114
.0500	RCFT 16 06 MO TiN	71, 114
.0600	RCFT 20 06 MO TiN	71, 114
1578		
.0245	CCFT 06 02 01 FR "G" TiN	73, 118, 85
.0247	CCFT 06 02 01 FL "G" TiN	73, 85, 118
.0250	CCFT 06 02 02 FR "G" TiN	73, 118, 85
.0252	CCFT 06 02 02 FL "G" TiN	73, 85, 118
.0255	CCFT 06 02 04 FR "G" TiN	73, 118, 85
.0257	CCFT 06 02 04 FL "G" TiN	73, 118, 85
.0350	CCFT 09 T3 02 FR "G" TiN	75, 118, 85
.0352	CCFT 09 T3 02 FL "G" TiN	75, 85, 118
.0355	CCFT 09 T3 04 FR "G" TiN	75, 85, 118
.0357	CCFT 09 T3 04 FL "G" TiN	75, 118, 85
.0360	CCFT 09 T3 08 FR "G" TiN	75, 85, 118
.0362	CCFT 09 T3 08 FL "G" TiN	75, 118, 85
.0750	CCFT 06 02 02 FR "K" TiN	73, 85, 118
.0752	CCFT 06 02 02 FL "K" TiN	73, 118, 85
.0755	CCFT 06 02 04 FR "K" TiN	73, 85, 118
.0757	CCFT 06 02 04 FL "K" TiN	73, 85, 118
.0855	CCFT 09 T3 04 FR "K" TiN	75, 118, 85
.0857	CCFT 09 T3 04 FL "K" TiN	75, 85, 118
.0860	CCFT 09 T3 08 FR "K" TiN	75, 118, 85
.0862	CCFT 09 T3 08 FL "K" TiN	75, 85, 118
1579		
.0245	DCFT 07 02 01 FR "G" TiN	77, 89, 119
.0247	DCFT 07 02 01 FL "G" TiN	77, 119, 89
.0250	DCFT 07 02 02 FR "G" TiN	77, 119, 89
.0252	DCFT 07 02 02 FL "G" TiN	77, 89, 119
.0255	DCFT 07 02 04 FR "G" TiN	77, 119, 89
.0257	DCFT 07 02 04 FL "G" TiN	77, 89, 119
.0357	DCFT 11 T3 04 FL "G" TiN	77, 89, 119
.0360	DCFT 11 T3 08 FR "G" TiN	77, 119, 89
.0362	DCFT 11 T3 08 FL "G" TiN	77, 89, 119
.0750	DCFT 07 02 02 FR "K" TiN	77, 89, 119
.0752	DCFT 07 02 02 FL "K" TiN	77, 119, 89
.0755	DCFT 07 02 04 FR "K" TiN	77, 89, 119
.0757	DCFT 07 02 04 FL "K" TiN	77, 119, 89
.0855	DCFT 11 T3 04 FR "K" TiN	77, 89, 119
.0857	DCFT 11 T3 04 FL "K" TiN	77, 119, 89
.0860	DCFT 11 T3 08 FR "K" TiN	77, 89, 119
.0862	DCFT 11 T3 08 FL "K" TiN	77, 89, 119
1581		
.0210	MPFT 04 02 PP FL TiN	87, 117
1582		
.0855	VCFT 16 04 04 FR "K" TiN	79, 121
.0857	VCFT 16 04 04 FL "K" TiN	79, 121

Nr.	Typ	Seite
.0860	VCFT 16 04 08 FR "K" TiN	79, 121
.0862	VCFT 16 04 08 FL "K" TiN	79, 121
1585		
.0700	APFT 16 04 PD FR "K" TiN	81, 113
.0750	APFT 16 04 04 FR "K" TiN	81, 113
1591		
.0200	SCFT 09 04 04 FN "G" TiN	83, 116
.0220	SCFT 09 04 08 FN "G" TiN	83, 116
.0250	SCFT 12 05 AC FN "G" TiN	83, 116
.0270	SCFT 12 05 04 FN "G" TiN	83, 116
.0290	SCFT 12 05 08 FN "G" TiN	83, 116
.0310	SCFT 12 05 12 FN "G" TiN	83, 116
.0700	SCFT 09 04 04 FN "K" TiN	83, 116
.0720	SCFT 09 04 08 FN "K" TiN	83, 116
.0770	SCFT 12 05 04 FN "K" TiN	83, 116
.0790	SCFT 12 05 08 FN "K" TiN	83, 116
.0810	SCFT 12 05 12 FN "K" TiN	83, 116
1598		
.0120	KLN 2 TiN	99, 101
.0122	KLR 2 TiN	99, 101
.0124	KLL 2 TiN	99, 101
.0130	KLN 3 TiN	99, 101
.0132	KLR 3 TiN	99, 101
.0134	KLL 3 TiN	99, 101
1651		
.0200	RCFT 06 02 MO TiAlN	71, 114
.0240	RCFT 08 03 MO TiAlN	71, 114
.0250	RCFT 08 03 MO TiAlN	114
.0300	RCFT 10 T3 MO TiAlN	71, 114
.0400	RCFT 12 04 MO TiAlN	71, 114
.0500	RCFT 16 06 MO TiAlN	71, 114
.0600	RCFT 20 06 MO TiAlN	71, 114
1653		
.0245	CCFT 06 02 01 FR "G" TiAlN	73, 118, 85
.0247	CCFT 06 02 01 FL "G" TiAlN	73, 85, 118
.0250	CCFT 06 02 02 FR "G" TiAlN	73, 118, 85
.0252	CCFT 06 02 02 FL "G" TiAlN	73, 118, 85
.0255	CCFT 06 02 04 FR "G" TiAlN	73, 118, 85
.0257	CCFT 06 02 04 FL "G" TiAlN	73, 85, 118
.0350	CCFT 09 T3 02 FR "G" TiAlN	75, 85, 118
.0352	CCFT 09 T3 02 FL "G" TiAlN	75, 85, 118
.0355	CCFT 09 T3 04 FR "G" TiAlN	75, 85, 118
.0357	CCFT 09 T3 04 FL "G" TiAlN	75, 118, 85
.0360	CCFT 09 T3 08 FR "G" TiAlN	75, 118, 85
.0362	CCFT 09 T3 08 FL "G" TiAlN	75, 118, 85
.0750	CCFT 06 02 02 FR "K" TiAlN	73, 118, 85
.0752	CCFT 06 02 02 FL "K" TiAlN	73, 85, 118
.0755	CCFT 06 02 04 FR "K" TiAlN	73, 85, 118
.0757	CCFT 06 02 04 FL "K" TiAlN	73, 85, 118
.0855	CCFT 09 T3 04 FR "K" TiAlN	75, 118, 85
.0857	CCFT 09 T3 04 FL "K" TiAlN	75, 85, 118
.0860	CCFT 09 T3 08 FR "K" TiAlN	75, 118, 85
.0862	CCFT 09 T3 08 FL "K" TiAlN	75, 118, 85
1654		
.0245	DCFT 07 02 01 FR "G" TiAlN	77, 119, 89
.0247	DCFT 07 02 01 FL "G" TiAlN	77, 119, 89
.0250	DCFT 07 02 02 FR "G" TiAlN	77, 119, 89
.0252	DCFT 07 02 02 FL "G" TiAlN	77, 89, 119
.0255	DCFT 07 02 04 FR "G" TiAlN	77, 89, 119
.0257	DCFT 07 02 04 FL "G" TiAlN	77, 89, 119
.0355	DCFT 11 T3 04 FR "G" TiAlN	77, 119, 89
.0357	DCFT 11 T3 04 FL "G" TiAlN	77, 89, 119
.0360	DCFT 11 T3 08 FR "G" TiAlN	77, 119, 89
.0362	DCFT 11 T3 08 FL "G" TiAlN	77, 119, 89
.0750	DCFT 07 02 02 FR "K" TiAlN	77, 89, 119
.0752	DCFT 07 02 02 FL "K" TiAlN	77, 89, 119
.0755	DCFT 07 02 04 FR "K" TiAlN	77, 119, 89
.0757	DCFT 07 02 04 FL "K" TiAlN	77, 89, 119
.0855	DCFT 11 T3 04 FR "K" TiAlN	77, 119, 89
.0857	DCFT 11 T3 04 FL "K" TiAlN	77, 119, 89
.0860	DCFT 11 T3 08 FR "K" TiAlN	77, 119, 89
.0862	DCFT 11 T3 08 FL "K" TiAlN	77, 89, 119
1656		
.0210	MPFT 04 02 PP FL TiAlN	87, 117
1657		
.0855	VCFT 16 04 04 FR "K" TiAlN	79, 121
.0857	VCFT 16 04 04 FL "K" TiAlN	79, 121
.0860	VCFT 16 04 08 FR "K" TiAlN	79, 121
.0862	VCFT 16 04 08 FL "K" TiAlN	79, 121
1666		
.0200	SCFT 09 04 04 FN "G" TiAlN	83, 116
.0220	SCFT 09 04 08 FN "G" TiAlN	83, 116
.0250	SCFT 12 05 AC FN "G" TiAlN	83, 116
.0270	SCFT 12 05 04 FN "G" TiAlN	83, 116
.0290	SCFT 12 05 08 FN "G" TiAlN	83, 116
.0310	SCFT 12 05 12 FN "G" TiAlN	83, 116
.0700	SCFT 09 04 04 FN "K" TiAlN	83, 116
.0720	SCFT 09 04 08 FN "K" TiAlN	83, 116

Index

Nr.	Typ	Seite
.0770	SCFT 12 05 04 FN "K" TiAIN	83, 116
.0790	SCFT 12 05 08 FN "K" TiAIN	83, 116
.0810	SCFT 12 05 12 FN "K" TiAIN	83, 116
1791		
.0255	SCFT 12 05 AC FN-111 TiAIN	83, 116
.0265	SCFT 12 05 AC FN-111 AlCrN	83, 116
.0295	SCFT 12 05 08 FN-111 TiAIN	83, 116
.0305	SCFT 12 05 08 FN-111 AlCrN	83, 116
.0325	SCFT 12 05 08 FN-121 AlCrN	83, 116
1905		
.0200	SRDCN 16 16 06	70
.0220	SRDCN 20 20 08	70
.0240	SRDCN 20 20 10	70
.0260	SRDCN 25 25 12	70
.0280	SRDCN 32 25 16	70
.0290	SRDCN 32 32 20	70
.0300	SRSCR 16 16 06	70
.0305	SRSCl 16 16 06	70
.0320	SRSCR 20 20 08	70
.0325	SRSCl 20 20 08	70
.0340	SRSCR 20 20 10	70
.0345	SRSCl 20 20 10	70
.0360	SRSCR 25 25 12	70
.0365	SRSCl 25 25 12	70
.0400	SRSCR 32 32 20	70
.0405	SRSCl 32 32 20	70
1910		
.0200	SCLCR 08 08 06	72
.0205	SCLCL 08 08 06	72
.0220	SCLCR 10 10 06	72
.0225	SCLCL 10 10 06	72
.0240	SCLCR 12 12 09	74
.0245	SCLCL 12 12 09	74
.0260	SCLCR 16 16 09	74
.0265	SCLCL 16 16 09	74
1917		
.0190	A08H SCLCR 06	84
.0195	A08H SCLCL 06	84
.0200	A08H SCLCR 06	84
.0205	A08H SCLCL 06	84
.0220	A10K SCLCR 06	84
.0225	A10K SCLCL 06	84
.0240	A12L SCLCR 06	84
.0245	A12L SCLCL 06	84
.0260	A16Q SCLCR 09	84
.0265	A16Q SCLCL 09	84
.0280	A20R SCLCR 09	84
.0285	A20R SCLCL 09	84
1918		
.0180	S06J SMFPR 04	86
.0200	S08J SMFPR 04	86
1920		
.0200	SDJCR 10 10 07	76
.0205	SDJCL 10 10 07	76
.0220	SDJCR 12 12 11	76
.0225	SDJCL 12 12 11	76
.0240	SDJCR 16 16 11	76
.0245	SDJCL 16 16 11	76
.0260	SDJCR 20 20 11	76
.0265	SDJCL 20 20 11	76
1927		
.0200	A12 L SDQCR 07	88
.0205	A12L SDQCL 07	88
.0220	A16Q SDQCR 07	88
.0225	A16Q SDQCL 07	88
.0240	A20R SDQCR 11	88
.0245	A20R SDQCL 11	88
.0300	A12L SDUCR 07	88
.0305	A12L SDUCL 07	88
.0320	A16Q SDUCR 07	88
.0325	A16Q SDUCL 07	88
.0340	A20R SDUCR 11	88
.0345	A20R SDUCL 11	88
1935		
.0360	SVJCR 25 25 16	78
.0365	SVJCL 25 25 16	78
1940		
.0200	SAGPR 12 12 16	80
.0205	SAGPL 12 12 16	80
.0220	SAGPR 16 16 16	80
.0225	SAGPL 16 16 16	80
.0240	SAGPR 20 20 16	80
.0245	SAGPL 20 20 16	80
.0260	SAGPR 25 25 16	80
.0265	SAGPL 25 25 16	80
1945		
.0300	SSSCR 12 12 09	82

Nr.	Typ	Seite
.0305	SSSCL 12 12 09	82
.0320	SSSCR 16 16 09	82
.0325	SSSCL 16 16 09	82
.0340	SSSCR 20 20 12	82
.0345	SSSCL 20 20 12	82
.0360	SSSCR 25 25 12	82
.0365	SSSCL 25 25 12	82
1982		
.0300	KLH 313 R	98
.0305	KLH 313 L	98
.0320	KLH 317 R	98
.0325	KLH 317 L	98
1986		
.0200	KLSH 210 R	100
.0205	KLSH 210 L	100
.0220	KLSH 212 R	100
.0225	KLSH 212 L	100
.0240	KLSH 216 R	100
.0245	KLSH 216 L	100
.0260	KLSH 220 R	100
.0265	KLSH 220 L	100
.0300	KLSH 312 R	100
.0305	KLSH 312 L	100
.0320	KLSH 316 R	100
.0325	KLSH 316 L	100
.0340	KLSH 320 R	100
.0345	KLSH 320 L	100
1988		
.0200	KLKH 25.26 R	102
.0205	KLKH 25.26 L	102
4120		
.0357	Ø 2.0 x 50 mm	90
.0361	Ø 2.0 x 100 mm	90
.0387	Ø 2.5 x 50 mm	90
.0391	Ø 2.5 x 100 mm	90
.0406	Ø 3.0 x 100 mm	90
.0421	Ø 3.5 x 100 mm	90
.0433	Ø 4.0 x 63 mm	90
.0436	Ø 4.0 x 100 mm	90
.0646	Ø 5.0 x 100 mm	90
.0676	Ø 6.0 x 100 mm	90
.0680	Ø 6.0 x 160 mm	90
.0695	Ø 7.0 x 160 mm	90
.0706	Ø 8.0 x 100 mm	90
.0710	Ø 8.0 x 160 mm	90
.0711	Ø 8.0 x 200 mm	90
.0736	Ø 10.0 x 100 mm	90
.0740	Ø 10.0 x 160 mm	90
.0741	Ø 10.0 x 200 mm	90
.0766	Ø 12.0 x 100 mm	90
.0771	Ø 12.0 x 200 mm	90
.0801	Ø 14.0 x 200 mm	90
.0831	Ø 16.0 x 200 mm	90
.0846	Ø 18.0 x 200 mm	90
.0861	Ø 20.0 x 200 mm	90
.0876	Ø 22.0 x 200 mm	90
.0891	Ø 25.0 x 200 mm	90
.0906	Ø 30.0 x 200 mm	90
4140		
.0102	4 x 4 x 63 mm	91
.0122	5 x 5 x 63 mm	91
.0142	6 x 6 x 63 mm	91
.0145	6 x 6 x 100 mm	91
.0148	6 x 6 x 160 mm	91
.0149	6 x 6 x 200 mm	91
.0169	7 x 7 x 200 mm	91
.0182	8 x 8 x 63 mm	91
.0185	8 x 8 x 100 mm	91
.0188	8 x 8 x 160 mm	91
.0189	8 x 8 x 200 mm	91
.0222	10 x 10 x 63 mm	91
.0225	10 x 10 x 100 mm	91
.0228	10 x 10 x 160 mm	91
.0229	10 x 10 x 200 mm	91
.0265	12 x 12 x 100 mm	91
.0268	12 x 12 x 160 mm	91
.0269	12 x 12 x 200 mm	91
.0309	14 x 14 x 200 mm	91
.0349	16 x 16 x 200 mm	91
.0369	18 x 18 x 200 mm	91
.0389	20 x 20 x 200 mm	91
.0449	25 x 25 x 200 mm	91
.0529	32 x 32 x 200 mm	91
4160		
.0135	6 x 4 x 100 mm	92
.0165	8 x 2 x 100 mm	92
.0180	8 x 4 x 100 mm	92
.0210	10 x 3 x 100 mm	92
.0233	10 x 4 x 100 mm	92

Nr.	Typ	Seite
.0240	10 x 5 x 100 mm	92
.0258	10 x 6 x 160 mm	92
.0259	10 x 6 x 200 mm	92
.0274	10 x 8 x 200 mm	92
.0285	12 x 3 x 100 mm	92
.0300	12 x 5 x 100 mm	92
.0318	12 x 6 x 160 mm	92
.0319	12 x 6 x 200 mm	92
.0334	12 x 8 x 200 mm	92
.0349	12 x 10 x 200 mm	92
.0364	14 x 6 x 200 mm	92
.0379	14 x 8 x 200 mm	92
.0454	15 x 10 x 200 mm	92
.0469	16 x 8 x 200 mm	92
.0484	16 x 10 x 200 mm	92
.0649	20 x 6 x 200 mm	92
.0679	20 x 10 x 200 mm	92
.0694	20 x 12 x 200 mm	92
.0709	20 x 15 x 200 mm	92
.0784	25 x 10 x 200 mm	92
.0799	25 x 12 x 200 mm	92
.0814	25 x 20 x 200 mm	92
.0889	32 x 20 x 200 mm	92
4350		
.0210	8 x 40 x 0.50 mm N TiN	95
.0220	8 x 40 x 0.70 mm N TiN	95
.0230	8 x 40 x 0.80 mm N TiN	95
.0240	8 x 40 x 0.90 mm N TiN	95
.0250	8 x 40 x 1.10 mm N TiN	95
.0260	8 x 40 x 1.30 mm N TiN	95
.0270	8 x 40 x 1.60 mm N TiN	95
.0272	8 x 40 x 1.60 mm R TiN	95
.0274	8 x 40 x 1.60 mm L TiN	95
.0280	8 x 40 x 1.85 mm N TiN	95
.0310	10 x 44 x 0.50 mm N TiN	95
.0320	10 x 44 x 0.70 mm N TiN	95
.0330	10 x 44 x 0.80 mm N TiN	95
.0340	10 x 44 x 0.90 mm N TiN	95
.0350	10 x 44 x 1.10 mm N TiN	95
.0360	10 x 44 x 1.30 mm N TiN	95
.0370	10 x 44 x 1.60 mm N TiN	95
.0372	10 x 44 x 1.60 mm R TiN	95
.0374	10 x 44 x 1.60 mm L TiN	95
.0380	10 x 44 x 1.85 mm N TiN	95
.0420	12 x 48 x 1.10 mm N TiN	95
.0430	12 x 48 x 1.30 mm N TiN	95
.0440	12 x 48 x 1.60 mm N TiN	95
.0442	12 x 48 x 1.60 mm R TiN	95
.0444	12 x 48 x 1.60 mm L TiN	95
.0450	12 x 48 x 1.85 mm N TiN	95
.0460	12 x 48 x 2.15 mm N TiN	95
.0462	12 x 48 x 2.15 mm R TiN	95
.0464	12 x 48 x 2.15 mm L TiN	95
.0470	12 x 48 x 2.65 mm N TiN	95
.0520	16 x 54 x 1.60 mm N TiN	95
.0522	16 x 54 x 1.60 mm R TiN	95
.0524	16 x 54 x 1.60 mm L TiN	95
.0530	16 x 54 x 1.85 mm N TiN	95
.0540	16 x 54 x 2.15 mm N TiN	95
.0550	16 x 54 x 3.15 mm N TiN	95
.0552	16 x 54 x 3.15 mm R TiN	95
.0554	16 x 54 x 3.15 mm L TiN	95
.0560	16 x 54 x 4.15 mm N TiN	95
4360		
.0410	6 x 20 x 0.5 mm RN TiN	97
.0415	6 x 20 x 0.5 mm LN TiN	97
.0430	6 x 20 x 0.8 mm RN TiN	97
.0435	6 x 20 x 0.8 mm LN TiN	97
.0450	6 x 20 x 1.1 mm RN TiN	97
.0455	6 x 20 x 1.1 mm LN TiN	97
.0550	7 x 25 x 1.1 mm RN TiN	97
.0555	7 x 25 x 1.1 mm LN TiN	97
.0560	7 x 25 x 1.3 mm RN TiN	97
.0565	7 x 25 x 1.3 mm LN TiN	97
.0570	7 x 25 x 1.6 mm RN TiN	97
.0572	7 x 25 x 1.6 mm RR TiN	97
.0574	7 x 25 x 1.6 mm RL TiN	97
.0575	7 x 25 x 1.6 mm LN TiN	97
.0577	7 x 25 x 1.6 mm LR TiN	97
.0579	7 x 25 x 1.6 mm LL TiN	97
4370		
.0300	16 x 10 mm	104
.0400	20 x 12 mm	104
.0500	25 x 16 mm	104
.0700	32 x 20 mm	104
.0800	40 x 25 mm	104
4390		
.0200	Klemmhalter (8 mm)	94
.0300	Klemmhalter (10 mm)	94

Index

Nr.	Typ	Seite
.0400	Klemmhalter (12 mm)	94
.0500	Klemmhalter (16 mm)	94
4395		
.0400	10 x 10 x 140 mm R	96
.0405	10 x 10 x 140 mm L	96
.0500	12 x 12 x 140 mm R	96
.0505	12 x 12 x 140 mm L	96
.0530	16 x 16 x 140 mm R	96
.0535	16 x 16 x 140 mm L	96
.0560	20 x 20 x 140 mm R	96
.0565	20 x 20 x 140 mm L	96
Test		
.ikel		15